



### Electrical Specifications

**Cutoff Frequency (Fc):** 6800 MHz

**Passband:** 6800-12000 MHz

**Passband Insertion Loss:** 2.0dB Max.

**Passband Return Loss:** 10dB Min.

**Rejection:** 40 dB Min. @ 0-3500 MHz

### Mechanical

**Connector Type:** SMA(F)

**Dimensions:** 1.5" x 0.75" x 0.5"

### Environmental

**Operating Temperature:** -25°C to +70°C

**Storage Temperature:** -40°C to +90°C

**Shock:** 10 G. 11ms

**Vibration:** 10 G. 5 to 200Hz

### Outline Drawing:

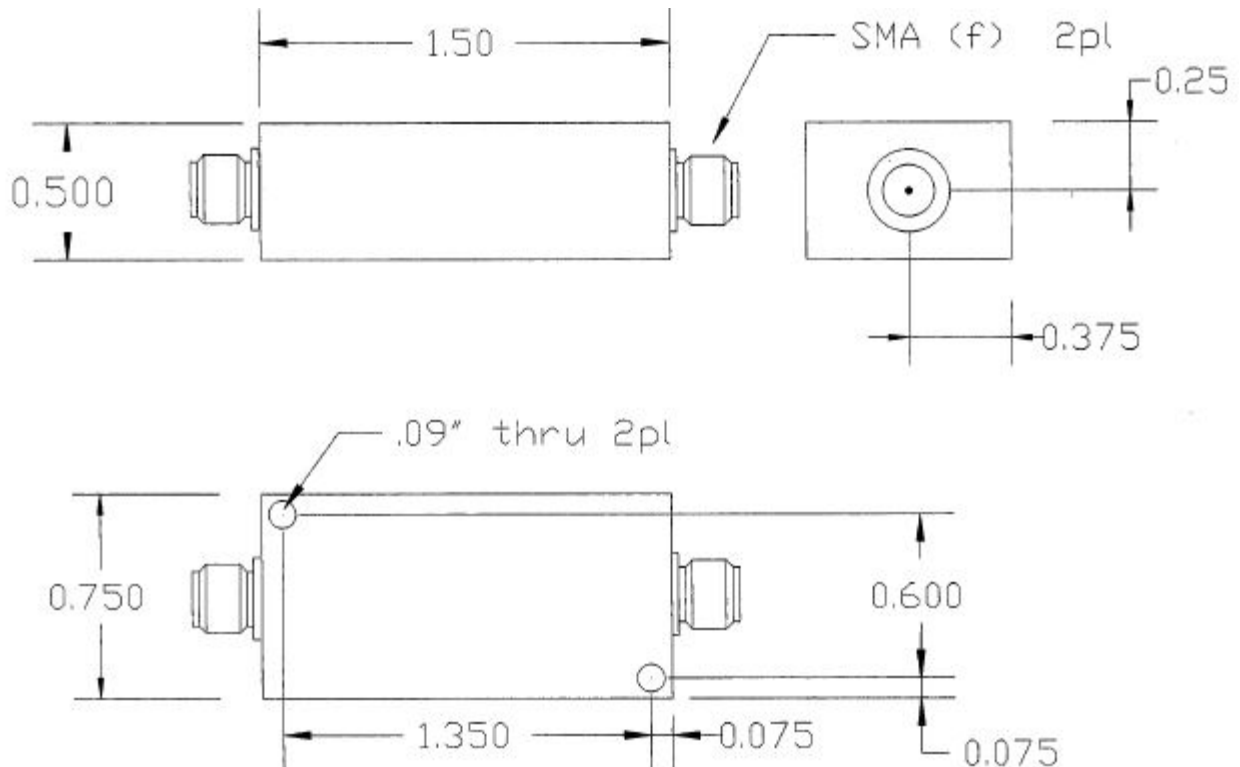



**Response Plot :**

