

DC Fan Motors

SANACE 120G Type

High wind capacity type

General specifications

Life expectancy 40,000 hours, (survival rate: 90% at 60°C, rated voltage)

Motor protection system .. Current cut system (with reverse-connection protection)

Dielectric strength 50/60 Hz, 500 VAC, 1 minute
(between lead conductor and frame)

Operating thermally range -10°C to +60°C (non-condensing)

Fan power lead G, E, A, H, F speeds, ⊕ red, ⊖ black
M speeds, ⊕ red, ⊖ blue



38mm thick

Specifications

Model No	Rated voltage (V)	Operating voltage range (V)	Rated current (A)	Rated input (W)	Rated rotating speed (min ⁻¹)	Air flow (m ³ /min)	(CFM)	Static pressure (Pa)	Noise (dB[A])	Mass (g)
9G1212G102	12	10.2~13.8	0.98	11.76	3,600	3.88	137	135	49	330
9G1212E102			0.61	7.32	3,100	3.34	118	100	46	
9G1212H102			0.38	4.56	2,600	2.80	99	70.4	39	
9G1212F102			0.28	3.36	2,280	2.45	87	54.2	36	
9G1212M102	24	20.4~27.6	0.21	2.52	1,950	2.10	74	39.6	32	
9G1224G102			0.50	12	3,600	3.88	137	135	49	
9G1224E102			0.34	8.16	3,100	3.34	118	100	46	
9G1224H102			0.22	5.28	2,600	2.80	99	70.4	39	
9G1224F102	48	14~27.6	0.16	3.84	2,280	2.45	87	54.2	36	
9G1224M102			0.11	2.64	1,950	2.10	74	39.6	32	
9G1248G102			0.25	12	3,600	3.88	137	135	49	
9G1248E102			0.17	8.16	3,100	3.34	118	100	46	
9G1248H102	48	40.8~55.2	0.11	5.28	2,600	2.80	99	70.4	39	
9G1248F102			0.09	4.32	2,280	2.45	87	54.2	36	
9G1248M102			0.07	3.36	1,950	2.10	74	39.6	32	

Typical air flow and static pressure characteristics

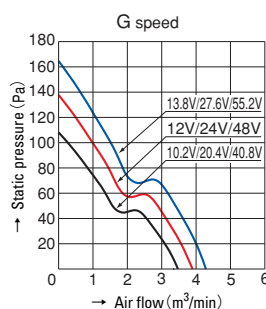

9G1212G102
9G1224G102
9G1248G102

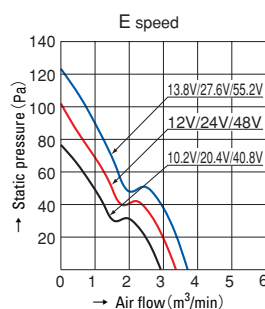

9G1212E102
9G1224E102
9G1248E102

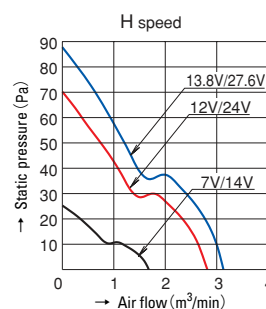

9G1212H102
9G1224H102

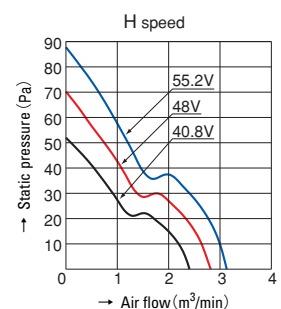

9G1248H102

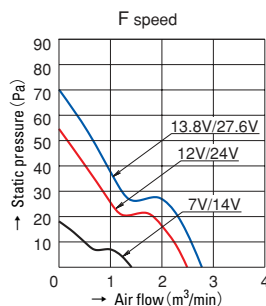

9G1212F102
9G1224F102

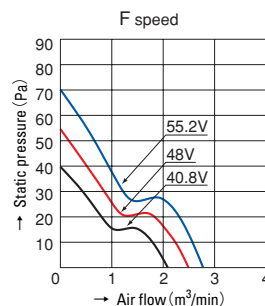

9G1248F102

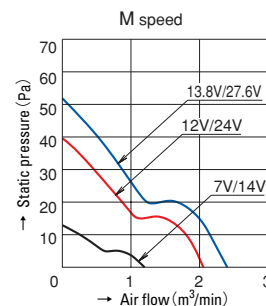

9G1212M102
9G1224M102

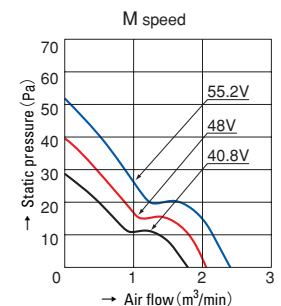

9G1248M102

Dimensions (unit : mm)

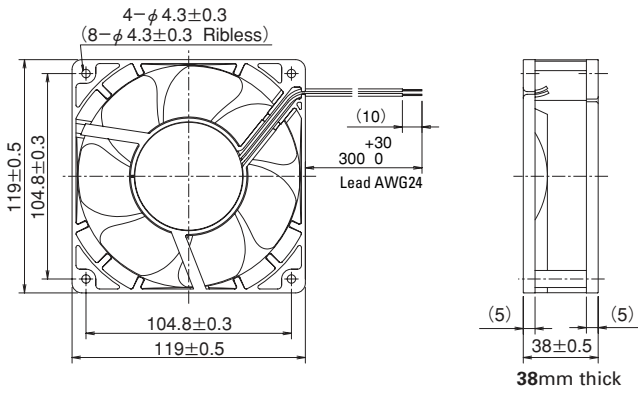

Reference dimensional diagram for installation holes (unit : mm)

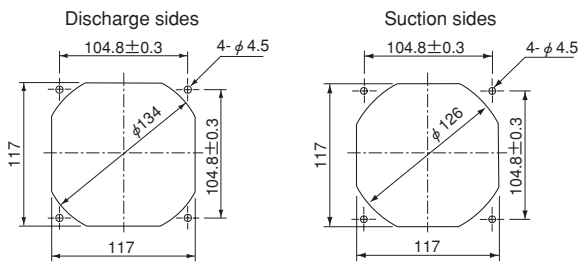

120mm

Notice

- The products shown in the catalog are subject to Japanese Export Control Law. Diversion contrary to the law of exporting country is prohibited.
- To protect against electrolytic cooling corrosion that may occur in locations of strong electromagnetic noise, we provide fans that are unaffected by electrolytic corrosion. Alternative measures to protect against electrolytic corrosion may include metallic finger guards or other metallic attachments. Please contact us for details.

SANYO DENKI