

General information

Part number	K11LOC-P16LCCO-6200
Termination	solder
Size	1
Locking principle	break , push
Coding	0_key
Cable Diameter	cable_mini_62
Cable outlet	standard

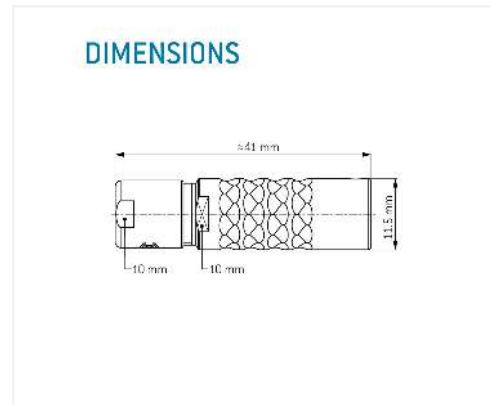
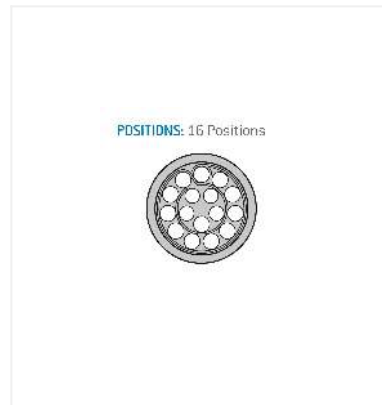
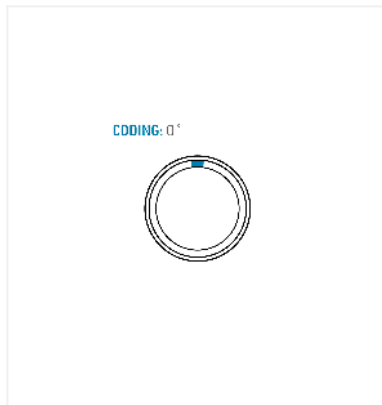

Contact insert description

Number of contacts	16
Contact type	sockets
Contact diameter	05mm
Insulator material	peek
Wire cross section	28_awg
Termination	solder
Termination diameter	045mm

reverse\_gender\_on\_request

Technical information

Max. creepage and air clearance distance	04_mm	09_mm
Nominal current single contact	04_a	iec_60512_5_2
Nominal current insert	2_A	vde_0298_4
Test voltage	09_kv_ac	sae_13441

safety\_text

Mechanical and environmental data

Degree of protection*	ip50
Operating temperature	40_120_c
Mating cycles	5000

mated\_unmated

Material and surface treatments

Housing	m_chrome
Contact	cu_alloy_gold

safety\_text\_2  
ul\_text  
illustrative\_text