

SE Relays Printed Circuit Board & Reed Relays

Catalog
2021

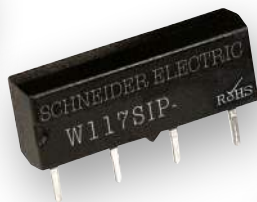

■ Series Overview	3
■ 117SIP Relays	4
■ 107DIP Relays	7
■ 171DIP Relays	10
■ 172DIP Relays	13
■ 276 Series Relays	16
■ 976 Series Relays	19
■ Application Data	22
■ Selection Guide	24
■ Website Guide	25

Built in small industry-standard packages, the SE Relays line of printed circuit board (PCB) relays is ideal for a variety of applications.

Key Features

- Space-saving package design
- Single and double pole switching
- Ratings range from 0.25 to 20 A
- Sealed for wash-down process
- Wave solderable



117SIP



107DIP



171DIP



172DIP



276



976

Series	Style	Contact Configuration	Output Current Range (A)	Output Voltage Range	Minimum Switching Requirement (mA)	Response Time (ms)	Page
117SIP	Miniature reed relay	SPST	0.25–0.35	120 Vac, 200 Vdc	10	0.45	4
107DIP	Miniature reed relay	SPST	0.25–0.35	120 Vac, 100 Vdc	10	1	7
171DIP	Miniature reed relay	SPST; DPST	0.25–0.35	60–120 Vac, 100 Vdc	10	1	10
172DIP	Miniature reed relay	SPDT; DPDT	0.25–0.35	60 Vac, 100 Vdc	10	1	13
276	Electromechanical relay	SPST; SPDT	7–10	240 Vac, 30 Vdc	100	10	16
976	Electromechanical relay	SPST; DPDT	5–20	240 Vac, 30–48 Vdc	100	10	19

Description

SE Relays PCB & Reed Relays

117SIP

SPST, 0.35 A (AC); 0.25 A (DC)

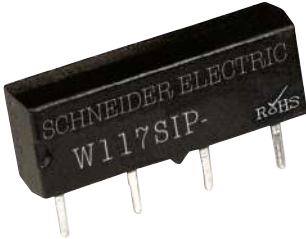

117SIP

Description

The 117SIP reed relays are uniquely designed in a standard style in-line package capable of switching up to 0.35 A (AC); 0.25 A (DC).

Feature	Benefit
Small size	Saves space on a PC board
High shock resistance (50 g-n)	Helps avoid damage in harsh conditions
Industry standard pin spacing	Designed for simple routing on PC board
Can withstand a lead-free solder reflow process	Meets industry standards
RoHS Compliant	Meets industry standards for RoHS compliant reflow processes

Rated Output Current	Contact Configuration	Input Voltage (Vdc)	Coil Resistance (Ω)	Wiring Diagram	Standard Part Number
0.35 A (AC); 0.25 A (DC)	SPST-NO	5	500	A	117SIP-1
		12	1000	A	117SIP-3
	SPST-NC	5	500	B	117SIP-22
	SPST-NO w/clamping diode	5	500	C	117SIP-6
	SPST-NC w/clamping diode	5	500	D	117SIP-18

Part Number Explanation

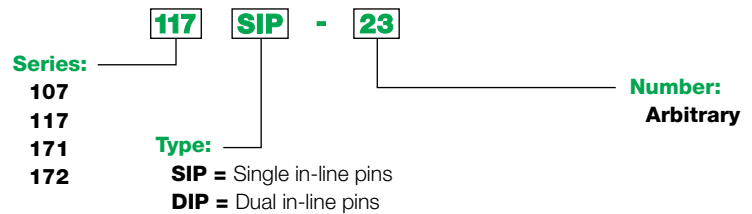

Specifications (UL 508)

Part Number 117SIP	Specifications
Input Characteristics	
Input Voltage Range	5–24 Vdc
Operating Range (% of Nominal)	80%–110%
Average Power Consumption	0.29 W
Drop-out Voltage Threshold	10%
Output Characteristics	
Contact Configuration	SPST-NO; SPST-NC
Contact Materials	Ruthenium
Output Current Load	0.35 A (AC); 0.25 A (DC)
Output Voltage Range	120 Vac; 200 Vdc
Output Load Wattage	10 W
Minimum Switching Requirement	1 mA
General Characteristics	
Electrical Life (Operations at rated current)	200,000 operations
Mechanical Life (Unpowered)	100,000,000 operations
Operating Time (Response time)	1 ms
Dielectric Strength (Between coil and contact)	500 V(rms)
Dielectric Strength (Between poles)	500 V(rms)
Dielectric Strength (Between contacts)	200 V(rms)
Storage Temperature Range	-40–105 °C (-40–221 °F)
Operating Temperature Range	-40–85 °C (-40–185 °F)
Vibration Resistance (Operational)	20 g-n, 10–2000 Hz
Shock Resistance	50 g-n
Weight	1 g (0.035 oz)
Agency Approvals	RoHS

SE Relays PCB & Reed Relays

117SIP

SPST, 0.35 A (AC); 0.25 A (DC)

Dimensions: Inches (Millimeters)

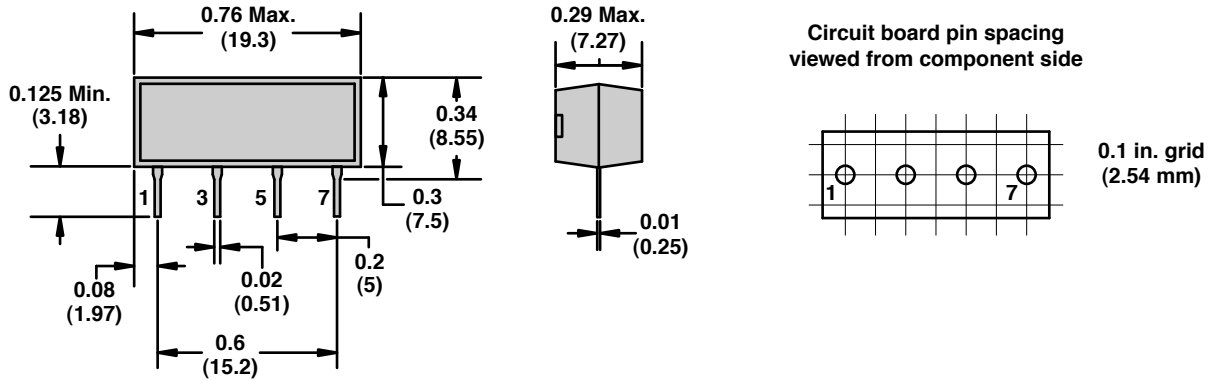

Wiring Diagrams

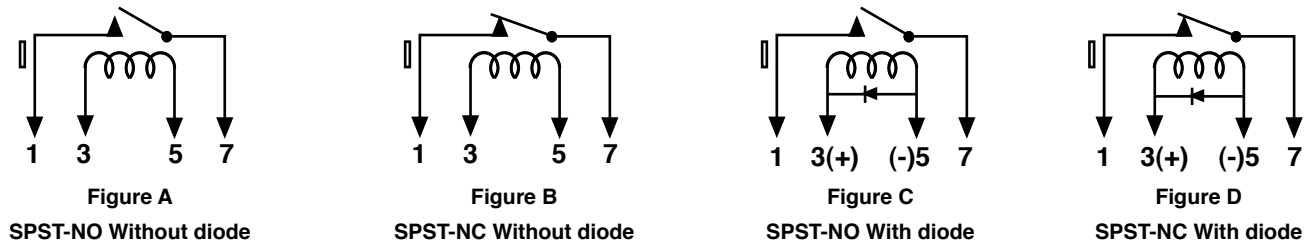

Description

SE Relays PCB & Reed Relays

107DIP

SPST-NO, 0.35 A (AC); 0.25 A (DC)



107DIP

Description

The 107DIP reed relays are uniquely designed in a standard style dual in-line package capable of switching up to 0.35 A (AC); 0.25 A (DC).

Feature	Benefit
Small size	Saves space on a PC board
High shock resistance (50 g-n)	Helps avoid damage in harsh conditions
Industry standard pin spacing	Designed for simple routing on PC board
Can withstand a lead-free solder reflow process	Meets industry standards
RoHS Compliant	Meets industry standards for RoHS compliant reflow processes

Rated Output Current	Contact Configuration	Input Voltage (Vdc)	Coil Resistance (Ω)	Wiring Diagram	Standard Part Number
0.35 A (AC); 0.25 A (DC)	SPST-NO	5	500	E	107DIP-1
		12	1000	E	107DIP-3
	SPST-NO w/clamping diode	5	500	F	107DIP-5
		12	1000	F	107DIP-7

Part Number Explanation

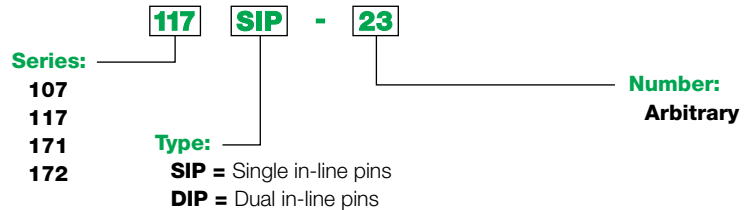

SE Relays PCB & Reed Relays

107DIP

SPST-NO, 0.35 A (AC); 0.25 A (DC)

Specifications (UL 508)

Part Number 107DIP	Specifications
Input Characteristics	
Input Voltage Range	5–24 Vdc
Operating Range (% of Nominal)	80%–110%
Average Power Consumption	0.29 W
Drop-out Voltage Threshold	10%
Output Characteristics	
Contact Configuration	SPST-NO
Contact Materials	Ruthenium
Output Current Load	0.35 A (AC); 0.25 A (DC)
Output Voltage Range	120 Vac; 100 Vdc
Output Load Wattage	10 W
Minimum Switching Requirement	1 mA
General Characteristics	
Electrical Life (Operations at rated current)	200,000 operations
Mechanical Life (Unpowered)	100,000,000 operations
Operating Time (Response time)	1 ms
Dielectric Strength (Between coil and contact)	1000 V(rms)
Dielectric Strength (Between poles)	1000 V(rms)
Dielectric Strength (Between contacts)	200 V(rms)
Storage Temperature Range	-40–105 °C (-40–221 °F)
Operating Temperature Range	-40–85 °C (-40–185 °F)
Vibration Resistance (Operational)	20 g-n, 10–2000 Hz
Shock Resistance	50 g-n
Weight	1 g (0.035 oz)
Agency Approvals	RoHS

SE Relays PCB & Reed Relays

107DIP

SPST-NO, 0.35 A (AC); 0.25 A (DC)

Dimensions: Inches (Millimeters)

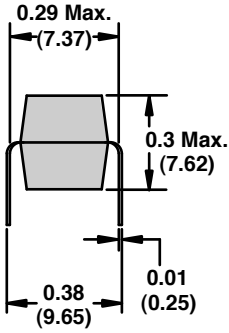
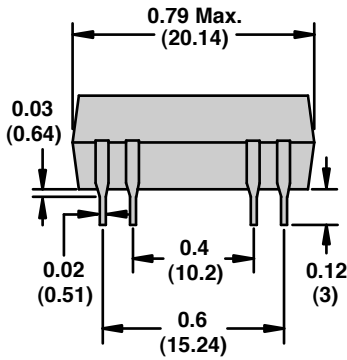

Circuit board pin spacing
viewed from component side

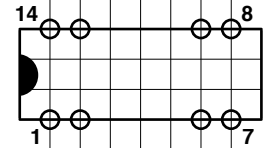

0.1 in. grid
(2.54 mm)

Wiring Diagrams

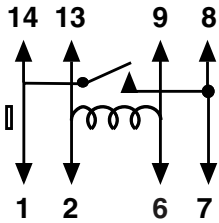

Figure E

SPST-NO Without diode

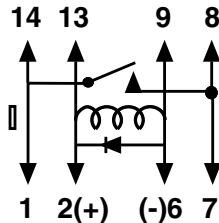

Figure F

SPST-NO With diode

Description

SE Relays PCB & Reed Relays

171DIP

SPST, 0.35 A (AC); 0.25 A (DC)

DPST-NO, 0.35 A (AC); 0.25 A (DC)

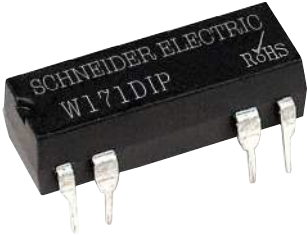

171DIP

Description

The 171DIP reed relays are uniquely designed in a standard style dual in-line package capable of switching up to 0.35 A (AC); 0.25 A (DC).

Feature	Benefit
Small size	Saves space on a PC board
High shock resistance (50 g-n)	Helps avoid damage in harsh conditions
Industry standard pin spacing	Designed for simple routing on PC board
Can withstand a lead-free solder reflow process	Meets industry standards
RoHS Compliant	Meets industry standards for RoHS compliant reflow processes

Rated Output Current	Contact Configuration	Input Voltage (Vdc)	Coil Resistance (Ω)	Wiring Diagram	Standard Part Number
0.35 A (AC); 0.25 A (DC)	SPST-NO	5	500	G	171DIP-2
		12	1000	G	171DIP-4
	SPST-NO w/clamping diode	5	500	H	171DIP-7
		24	2200	H	171DIP-10
	SPST-NC	5	500	I	171DIP-12
		12	1000	I	171DIP-14
	SPST-NC w/clamping diode	5	500	J	171DIP-17
	DPST-NO	5	200	K	171DIP-21
		12	500	K	171DIP-23
	DPST-NO w/clamping diode	5	200	L	171DIP-25
		12	500	L	171DIP-27
			24	2200	L

Part Number Explanation

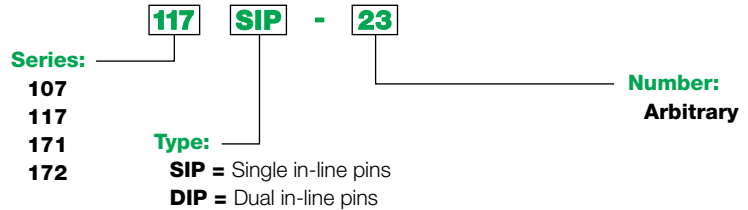

SE Relays PCB & Reed Relays

171DIP

SPST, 0.35 A (AC); 0.25 A (DC)

DPST-NO, 0.35 A (AC); 0.25 A (DC)

Specifications (UL 508)

Part Number 171DIP	Specifications
Input Characteristics	
Input Voltage Range	5–24 Vdc
Operating Range (% of Nominal)	80%–110%
Average Power Consumption	0.29 W
Drop-out Voltage Threshold	10%
Output Characteristics	
Contact Configuration	SPST-NO; SPST-NC; DPST-NO
Contact Materials	Ruthenium
Output Current Load	0.35 A (AC); 0.25 A (DC)
Output Voltage Range	60 Vac (SPST); 120 Vac (DPST); 100 Vdc
Output Load Wattage	10 W
Minimum Switching Requirement	1 mA
General Characteristics	
Electrical Life (Operations at rated current)	200,000 operations
Mechanical Life (Unpowered)	100,000,000 operations
Operating Time (Response time)	1 ms
Dielectric Strength (Between coil and contact)	1000 V(rms)
Dielectric Strength (Between poles)	1000 V(rms)
Dielectric Strength (Between contacts)	200 V(rms)
Storage Temperature Range	-40–105 °C (-40–221 °F)
Operating Temperature Range	-40–85 °C (-40–185 °F)
Vibration Resistance (Operational)	20 g-n, 10–2000 Hz
Shock Resistance	50 g-n
Weight	1 g (0.035 oz)
Agency Approvals	RoHS

SE Relays PCB & Reed Relays

171DIP

SPST, 0.35 A (AC); 0.25 A (DC)

DPST-NO, 0.35 A (AC); 0.25 A (DC)

Dimensions: Inches (Millimeters)

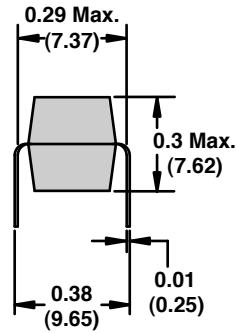
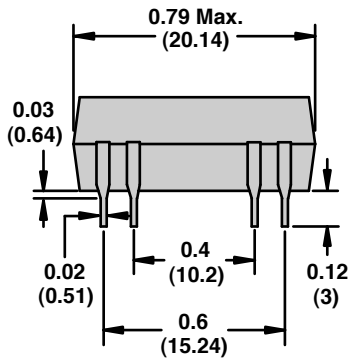

Circuit board pin spacing
viewed from component side

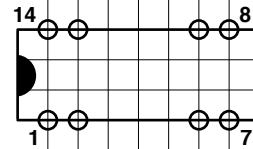

0.1 in. grid
(2.54 mm)

Wiring Diagrams

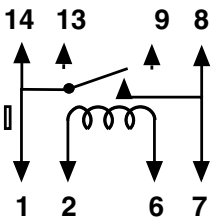

Figure G

SPST-NO Without diode

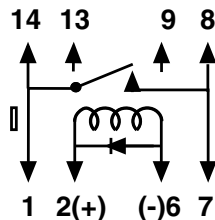

Figure H

SPST-NO With diode

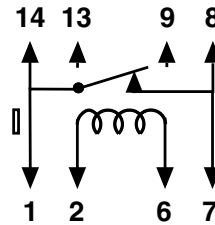

Figure I

SPST-NC Without diode

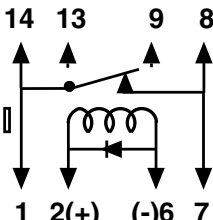

Figure J

SPST-NC With diode

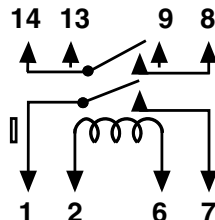

Figure K

DPST-NO Without diode

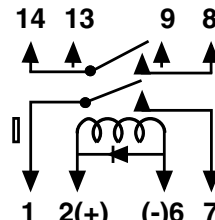

Figure L

DPST-NO With diode

Description

SE Relays PCB & Reed Relays

172DIP

SPDT, 0.35 A (AC); 0.25 A (DC)

DPDT, 0.35 A (AC); 0.25 A (DC)



172DIP

Description

The 172DIP reed relays are uniquely designed in a standard style dual in-line package capable of switching up to 0.35 A (AC); 0.25 A (DC).

Feature	Benefit
Small size	Saves space on a PC board
High shock resistance (50 g-n)	Helps avoid damage in harsh conditions
Industry standard pin spacing	Designed for simple routing on PC board
Can withstand a lead-free solder reflow process	Meets industry standards
RoHS Compliant	Meets industry standards for RoHS compliant reflow processes

Rated Output Current	Contact Configuration	Input Voltage (Vdc)	Coil Resistance (Ω)	Wiring Diagram	Standard Part Number
0.35 A (AC); 0.25 A (DC)	SPDT	5	200	M	172DIP-1
				O	172DIP-31
				P	172DIP-141
		12	1000	M	172DIP-3
				O	172DIP-33
				P	172DIP-145
	SPDT w/clamping diode	5	200	N	172DIP-5
				Q	172DIP-147
		12	1000	N	172DIP-7
				Q	172DIP-149
		24	2200	N	172DIP-8
				Q	172DIP-150
DPDT	12	266	R	172DIP-19	
DPDT w/clamping diode	5	46	S	172DIP-21	
	12	266	S	172DIP-23	

Part Number Explanation

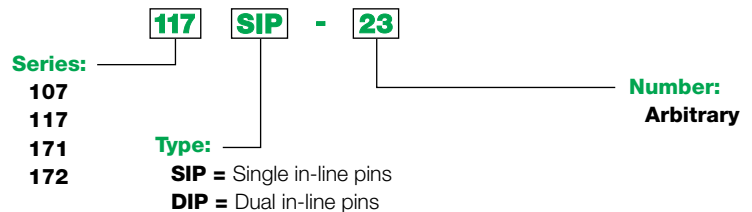

SE Relays PCB & Reed Relays

172DIP

SPDT, 0.35 A (AC); 0.25 A (DC)

DPDT, 0.35 A (AC); 0.25 A (DC)

Specifications (UL 508)

Part Number 172DIP	Specifications
Input Characteristics	
Input Voltage Range	5–24 Vdc
Operating Range (% of Nominal)	80%–110%
Average Power Consumption	0.29 W
Drop-out Voltage Threshold	10%
Output Characteristics	
Contact Configuration	SPDT; DPDT
Contact Materials	Ruthenium
Output Current Load	0.35 A (AC); 0.25 A (DC)
Output Voltage Range	60 Vac; 100 Vdc
Output Load Wattage	5 W
Minimum Switching Requirement	1 mA
General Characteristics	
Electrical Life (Operations at rated current)	200,000 operations
Mechanical Life (Unpowered)	100,000,000 operations
Operating Time (Response time)	1 ms
Dielectric Strength (Between coil and contact)	1000 V(rms)
Dielectric Strength (Between poles)	1000 V(rms)
Dielectric Strength (Between contacts)	150 V(rms)
Storage Temperature Range	-40–105 °C (-40–221 °F)
Operating Temperature Range	-40–85 °C (-40–185 °F)
Vibration Resistance (Operational)	20 g-n, 10–2000 Hz
Shock Resistance	50 g-n
Weight	1 g (0.035 oz)
Agency Approvals	RoHS

SE Relays PCB & Reed Relays

172DIP

SPDT, 0.35 A (AC); 0.25 A (DC)

DPDT, 0.35 A (AC); 0.25 A (DC)

Dimensions: Inches (Millimeters)

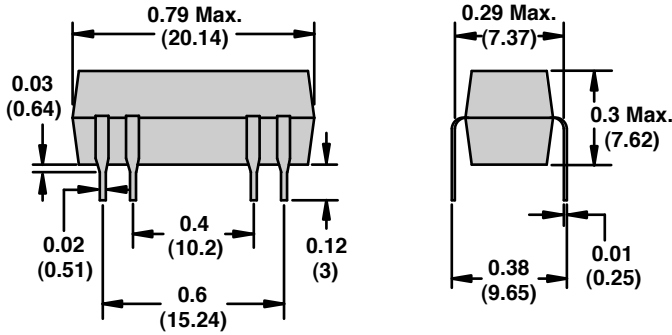

Circuit board pin spacing viewed from component side

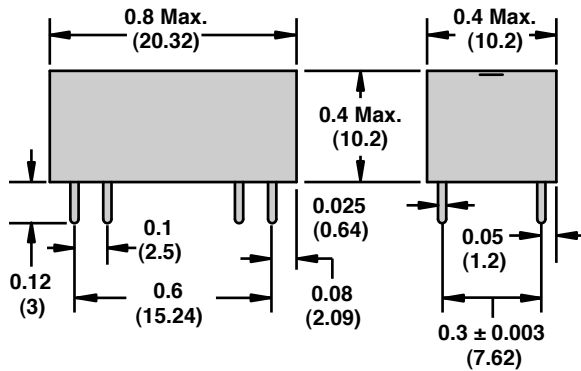
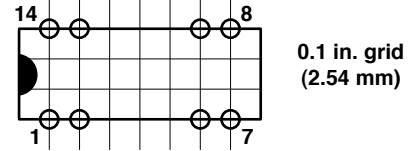

Wiring Diagrams

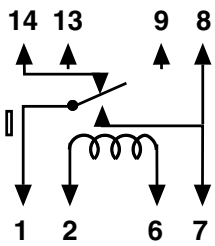

Figure M
SPDT Without diode

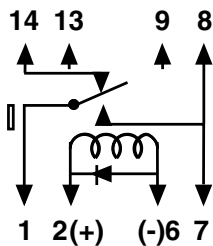

Figure N
SPDT With diode

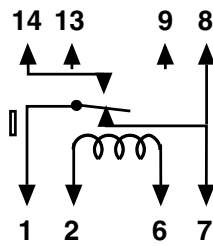

Figure O
SPDT Without diode

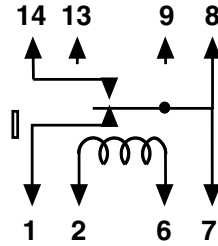

Figure P
SPDT Without diode

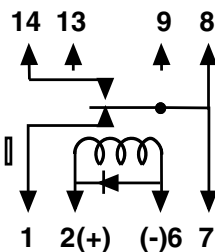

Figure Q
SPDT With diode

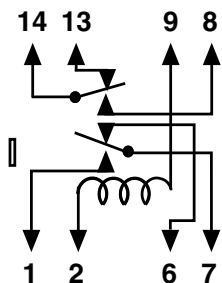

Figure R
DPDT Without diode

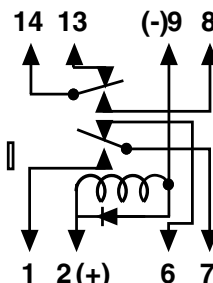

Figure S
DPDT With diode

Description

SE Relays PCB & Reed Relays

276

SPST, 10 A

SPDT, 7 A

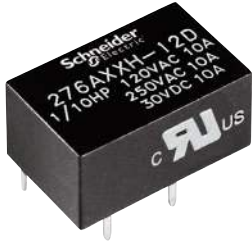

276

Description

The 276 series relays offer high switching capacity in a small package.

Feature	Benefit
High current switching capacity	Enables the relay to switch up to 10 A
HP rated	UL approved to switch up to 1/10 hp
Low-profile design	Uses less than 12.7 mm ² (0.5 in ²) of space on a PC board
Small footprint	Saves valuable space on a printed circuit board
Epoxy sealed	Allows the relay to be washed after assembly

Rated Output Load (A)	Contact Configuration	Input Voltage (Vdc)	Coil Resistance (Ω)	Wiring Diagram	Standard Part Number
7	SPDT	5	125	T	276XAXH-5D
		12	720	T	276XAXH-12D
		24	2880	T	276XAXH-24D
10	SPST-NO	5	125	U	276AXXH-5D
		12	720	U	276AXXH-12D

Part Number Explanation

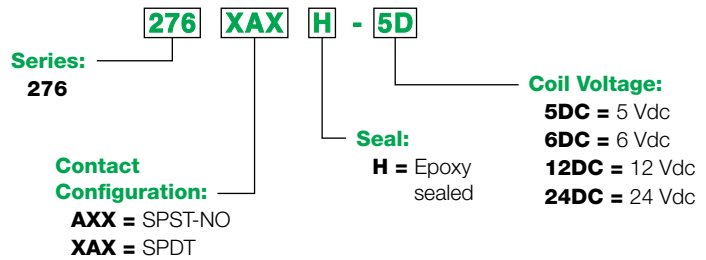

Specifications (UL 508)

Part Number	276XAX	276AXX
Input Characteristics		
Input Voltage Range	3–24 Vdc	
Operating Range (% of Nominal)	80%–110%	
Average Power Consumption	0.2 W	
Drop-out Voltage Threshold	10%	
Output Characteristics		
Contact Configuration	SPDT	SPST-NO
Contact Materials	Silver Alloy	
Output Current Load	7 A	10 A
Maximum Output Voltage	7 A @ 240 Vac 50/60 Hz; 7 A @ 30 Vdc; 1/10 hp @ 120 Vac	10 A @ 240 Vac 50/60 Hz; 10 A @ 30 Vdc; 1/6 hp @ 120 Vac
Minimum Switching Requirement	100 mA	
General Characteristics		
Electrical Life (Operations at rated current)	100,000 operations	
Mechanical Life (Unpowered)	5,000,000 operations	
Operating Time (Response time)	10 ms	
Dielectric Strength (Between coil and contact)	2000 Vac	
Dielectric Strength (Between contacts)	1000 Vac	
Storage Temperature Range	–40–85 °C (–40–185 °F)	
Operating Temperature Range	–40–70 °C (–40–158 °F)	
Vibration Resistance (Operational)	1.5 g-n, 10–55 Hz	
Shock Resistance	20 g-n	
Weight	5.5 g (0.19 oz)	
Agency Approvals	UR (E43641), RoHS	

Dimensions: Inches (Millimeters)

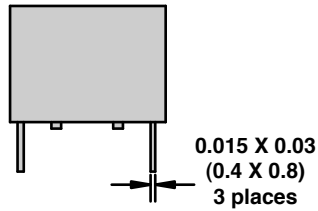
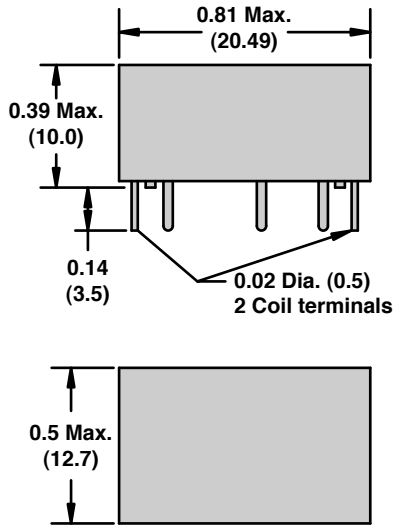

Circuit board pin spacing
viewed from component side

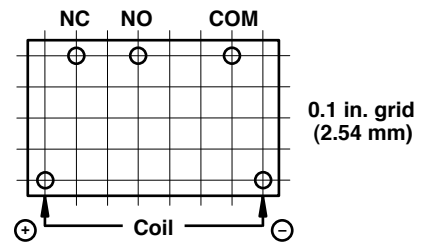

Wiring Diagrams

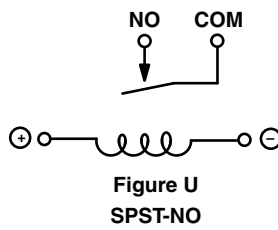
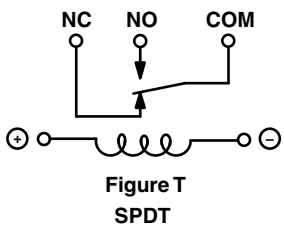

Description

SE Relays PCB & Reed Relays

976

SPDT, 12 to 20 A

DPDT, 5 A



976

Description

The 976 series enclosed printed circuit board relays are used to switch resistive and inductive loads in industrial applications.

Feature	Benefit
High current switching capacity	Enables the relay to switch up to 20 A
AC coil voltages available	Expands application use
8 mm coil to contact clearance	Meets international standards
Epoxy sealed	Allows the relay to be washed after assembly

Rated Output Current (A)	Contact Configuration	Input Voltage	Coil Resistance (Ω)	Wiring Diagram	Standard Part Number
5	DPDT	12 Vdc	270	X	976XBXH-12D
		24 Vac 50/60 Hz	250	X	976XBXH-24A
		24 Vdc	1100	X	976XBXH-24D
		120 Vac 50/60 Hz	5600	X	976XBXH-120A
		240 Vac 50/60 Hz	22000	X	976XBXH-240A
12	SPDT	24 Vac 50/60 Hz	250	V	976XAXH-24A
		24 Vdc	1100	V	976XAXH-24D
		120 Vac 50/60 Hz	5600	V	976XAXH-120A
		240 Vac 50/60 Hz	22000	V	976XAXH-240A
20	SPDT	24 Vac 50/60 Hz	250	W	976XAX97H-24A
		24 Vdc	1100	W	976XAX97H-24D
		120 Vac 50/60 Hz	5600	W	976XAX97H-120A

Part Number Explanation

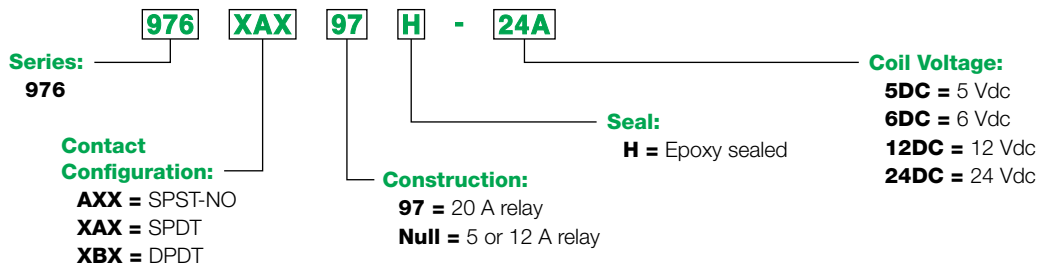

SE Relays PCB & Reed Relays

976

SPDT, 12 to 20 A

DPDT, 5 A

Specifications (UL 508)

Part Number	976XAX97H	976XAXH	976XBXH
Input Characteristics			
Input Voltage Range	6–240 Vac; 3–110 Vdc		
Operating Range (% of Nominal)	85%–110%		
Average Consumption	1.2 VA; 0.53 W		
Drop-out Voltage Threshold	30% AC; 10% DC		
Output Characteristics			
Contact Configuration	SPDT	SPDT	DPDT
Contact Materials	Silver Alloy		
Output Current Load	20 A	12 A	5 A
Maximum Switching Voltage	300 V		
Output Voltage Range	20 A @ 125 Vac 50/60 Hz; 16 A @ Vac 50/60 Hz; 20 A @ 30 Vdc; 10 A @ 48 Vdc	NO: 12 A @ 240 vac 50/60 Hz, 12 A @ 30 Vdc; NC: 10 A @ 240 Vac 50/60 Hz, 10 A @ 30 Vdc	5 A @ 240 Vac 50/60 Hz; 5 A @ 30 Vdc
General Characteristics			
Electrical Life (Operations at Rated Current)	100,000 operations		
Mechanical Life (Unpowered)	10,000,000 operations		
Operating Time (Response time)	15 ms		
Dielectric Strength (Between coil and contact)	5000 V(rms)		
Dielectric Strength (Between contacts)	1000 V(rms)		
Storage Temperature Range	-40–85 °C (-40–185 °F)		
Operating Temperature Range	-40–55 °C (-40–131 °F)		
Vibration Resistance (Operational)	3 g-n, 10-55 Hz		
Shock Resistance	10 g-n		
Weight	17 g (0.6 oz)		
Agency Approvals	UR (E191122), TUV, RoHS		

SE Relays PCB & Reed Relays

976

SPDT, 12 to 20 A

DPDT, 5 A

Dimensions: Inches (Millimeters)

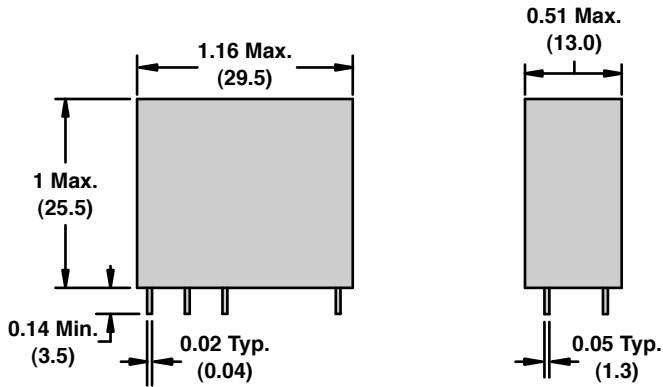

Circuit board pin spacing
viewed from component side

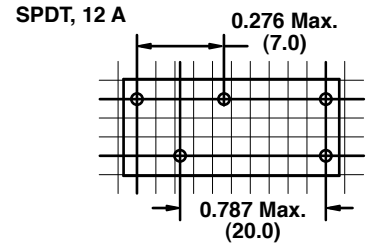

0.1 in. grid
(2.54 mm)

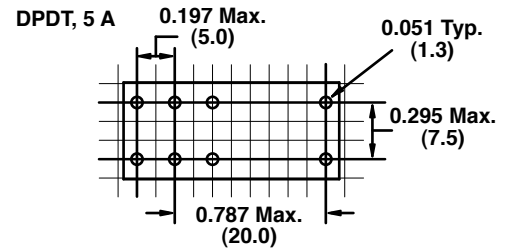
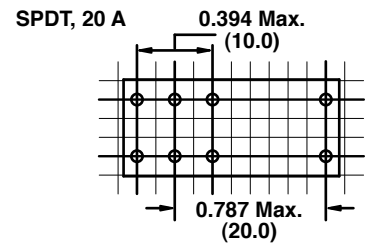

Wiring Diagrams

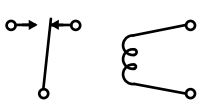

Figure V
SPDT, 12 A

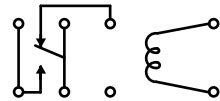

Figure W
SPDT, 20 A

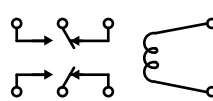

Figure X
DPDT, 5 A

Printed Circuit Board Relays

Printed circuit board (PCB) relays are compact relay devices used for power management in control system designs which require the relay to be mounted directly on the printed circuit board. They are used in applications where the relay must be small enough to be mounted on a printed circuit board. They must be easy to manufacture with the same machinery used in the printed circuit board line.

How Electromechanical PCB Relays Work

Electromechanical PCB relays consist of a coil, armature and contacts (see figure below). When power is applied to the coil, the resulting magnetic field causes the armature to move and the contacts to open or close.

Advantages

- Higher contact ratings than reed relays and smaller than traditional plug-in relays
- A wider range of form, fit and function than reed relays
- UL recognized to meet industry standards for product safety and compliance

How Reed Relays Work

Reed relays consist of a coil wrapped around a sealed glass tube containing the reeds and contacts (see figure below). When power is applied to the coil, the resulting magnetic field causes the reeds to move and the contacts to close (1).

Advantages

- Highly reliable due to longer mechanical and electrical life than electromechanical relays
- Can switch about ten times faster than an electromechanical relay with similar ratings
- Small, industry standard packaging which does not require unique machinery to populate

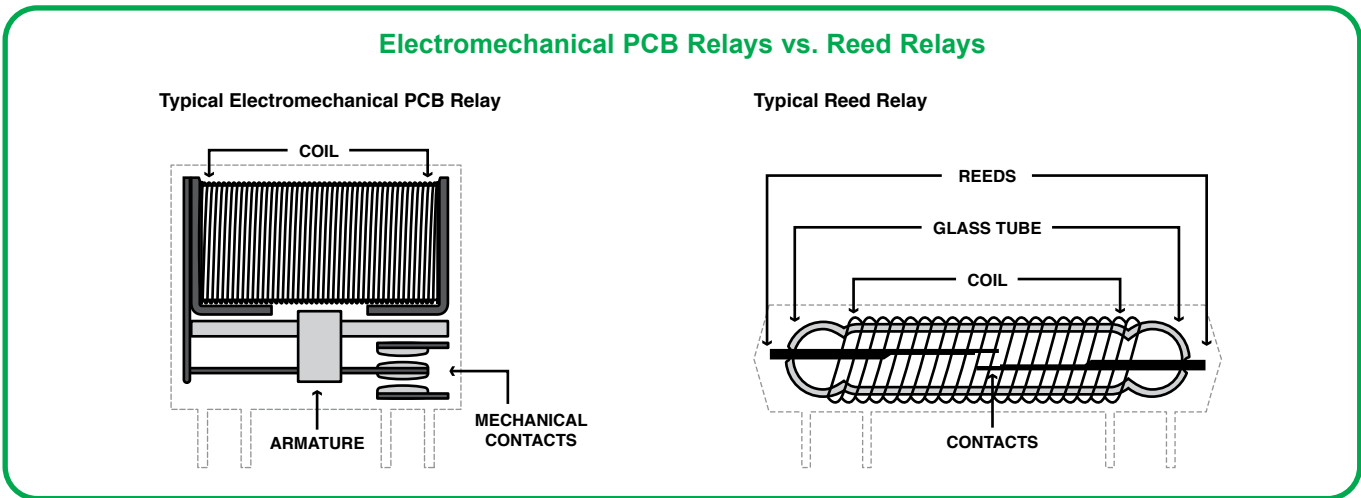

(1) Note that it is important to keep reed relays at a proper distance from each other because of the possibility of magnetic-interaction between them. Proper magnetic shielding must be used to contain stray magnetic fields. When installing reed relays into equipment, be aware of the devices in the equipment which can produce magnetic fields. Position the relays as far away as possible from any stray magnetic fields, and shield them to prevent false operations. A general rule is to space reed relays no closer together than 0.5 inches.

Applications

The PCB relay offer consists of reed relays ideal for applications requiring fast, reliable low-level switching capability in a very small package, and electromechanical PCB relays ideal for applications requiring higher ratings than reed relays and a smaller package than traditional plug-in relays.

Typical Examples of PCB and Reed Relay Applications



Automotive

Anti-lock brake systems, cruise control, doors, power steering, power windows, sunroofs



Electronics & Communication

Cellular phones, computers, copiers, microphones, radio transmitters, speakers

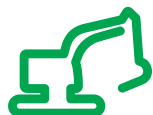

Construction & Security

Conveyor belts, elevators, emergency lamps, hoists, lifts, security alarms



HVAC & Refrigeration

Air conditioners, blowers, compressors, motorized ducts/vents, refrigerators, space heaters



Domestic Appliances

Coffee machines, dish washers, food processors, microwaves, ovens, stoves, vacuum cleaners, washing machines

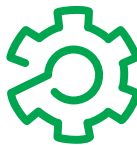

Industrial Automation

Human/machine interfaces, motion controllers, PLCs, power supplies, solder/wave reflow systems, variable speed drives

A Complete Range of Printed Circuit Board and Reed Relays

Printed circuit board and reed relays are compact devices used for high power and low level applications that require printed circuit board assembly.

Selecting a Printed Circuit Board or Reed Relay

The list below is an example of the specifications to look for when selecting a printed circuit board or reed relay.

Input voltage:	_____
Coil resistance:	_____
Contact rating:	_____
Contact configuration:	_____
Mounting style:	_____

Use the catalog specifications or online parametric search to determine a recommended part number (www.serelays.com).

The Schneider Electric Relays website (www.serelays.com) was designed to enable users to easily find the proper relay to fit design requirements and to help simplify and shorten workflow.

Easily find the proper relay to fit design requirements

■ Online Catalog

Find the right product by choosing specifications compare products side-by-side and view technical specifications, 2D and 3D drawings and associated accessories.

■ Cross Reference Search

Search our comprehensive database to identify by manufacturer and part number, and link directly to part specifications.

■ 3D CAD Library

View, email, download or insert a file directly into your open CAD software pane and select from 18 different file formats.

■ Order Free Samples

Schneider Electric offers free samples as a courtesy to individuals and companies evaluating our products in their designs and applications. Sample orders are subject to approval.

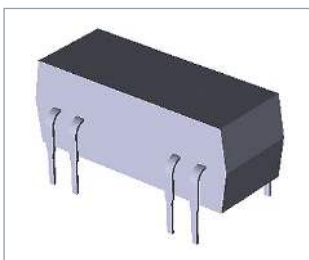

3D Models



PCB & Reed Relay Learning Tool

Simplify and shorten workflow

■ Interactive Tools

View interactive learning tools such as our PCB & Reed Relay Learning Tool which helps you learn more about SE Relays electromechanical PCB relays and reed relays, including industries and applications, principles of operation and advantages of using each type of relay.

■ Distributor Inventory Search

Search authorized distributors' current Schneider Electric inventory and buy online. (Buy online not available for all distributors).

Schneider Electric USA, Inc.
200 N. Martingale Rd.
Schaumburg, IL 60173
Tel: 847-441-2540
www.serelays.com

Electrical equipment should be installed, operated, serviced, and maintained only by qualified personnel. No responsibility is assumed by Schneider Electric for any consequences arising out of the use of this material.

© 2011–2021 Schneider Electric. All Rights Reserved.
Schneider Electric and Square D are trademarks and the property of Schneider Electric SE, its subsidiaries, and affiliated companies. All other trademarks are the property of their respective owners.

8501CT1001R10/21, 10/2021
Replaces 8501CT1001R01/17 dated 01/2017