

har-modular C9 module male straight Pa3



Image is for illustration purposes only. Please refer to product description.

Part number	02 53 909 1103
Specification	har-modular C9 module male straight Pa3
HARTING eCatalogue	https://b2b.harting.com/02539091103

Identification

Category	Connectors
Series	har-modular®
Identification	C9 module
Element	Male connector
Description of the contact	Straight

Version

Width of the module	10.16 mm
Termination method	Reflow soldering termination (THR) Wave soldering termination
Connection type	Mezzanine
Number of contacts	9
Leading contact on position	a3
Termination length	4.8 mm

Technical characteristics

Contact spacing (mating side)	2.54 mm
Rated current	2 A
Clearance distance	1 mm in the module 1.9 mm to module edge
Creepage distance	1 mm in the module 1.8 mm to module edge
Insulation resistance	$>10^{11} \Omega$
Contact resistance	$\leq 20 \text{ m}\Omega$



Pushing Performance
Since 1945

Technical characteristics

Limiting temperature	-55 ... +125 °C (during reflow soldering max. +240 °C for 15 s)
Insertion and withdrawal force	≤9 N
Performance level	1 acc. to IEC 60603-2
Mating cycles	≥500
Test voltage $U_{r.m.s.}$	1 kV
Isolation group	I ($600 \leq CTI$)
Hot plugging	No
Moisture Sensitivity Level (MSL)	1 acc. to ECA/IPC/JEDEC J-STD-020D

Material properties

Material	Polyamide (PA)
Colour	Black
Material (contacts)	Copper alloy
Surface (contacts)	Noble metal over Ni Mating side Sn over Ni Termination side
Material flammability class acc. to UL 94	V-0
RoHS	compliant
ELV status	compliant
China RoHS	e
REACH Annex XVII substances	Not contained
REACH ANNEX XIV substances	Not contained
REACH SVHC substances	Not contained
California Proposition 65 substances	Not contained
Fire protection on railway vehicles	EN 45545-2 (2020-08)
Requirement set with Hazard Levels	R22 (HL 1-3) R23 (HL 1-3)

Specifications and approvals

UL / CSA	UL 1977 ECBT2.E102079 CSA-C22.2 No. 182.3 ECBT8.E102079
Railway classification	F1/I2 acc. to NFF 16-101/102

Commercial data

Packaging size	20
----------------	----

Commercial data

Country of origin	Romania
European customs tariff number	85366990
GTIN	5713140197961
eCl@ss	27460201 PCB connector (board connector)

Current carrying capacity

The current carrying capacity of the connectors is limited by the thermal load capability of the contact element material including the connections and the insulating parts. The derating curve is therefore valid for currents which flow constantly (non-intermittent) through each contact element of the connector evenly, without exceeding the allowed maximum temperature.

Measuring and testing techniques acc. to IEC 60512-5-2

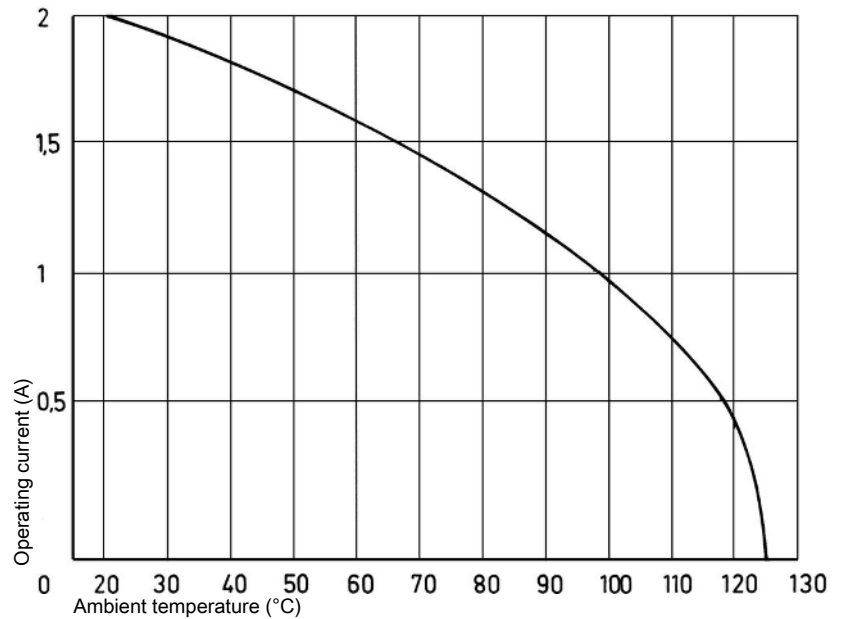

Cross section of solder termination

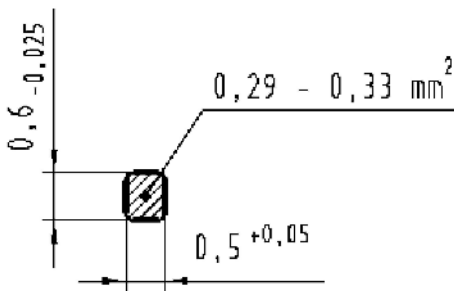

Quantity of solder paste

Before the components are assembled, solder paste must be applied to all the solder pads (for connecting surface-mount components) and the plated through holes. To ensure that the plated through holes are completely filled, significantly more solder paste must be applied than traditional solder pads on the pcb surface. There are numerous calculation methods available which are complicated to apply. The following rule of thumb has proved valuable in practice.

Required volume of paste = 2x (Volume of plated through hole - Volume of the connector termination in the hole)

Comment: the multiplier "2" compensates for solder paste shrinkage during soldering. For this purpose, it was assumed that 50% of the paste consists of the actual solder, the other 50% being soldering aids.

Soldering instructions

THR (ThroughHoleReflow) connectors are designed to be used in a reflow oven together with other SMD (SurfaceMountDevice) components. In the process, called as well "Pin in Hole Intrusive Reflow", the connectors are inserted into plated through holes in a comparable way to conventional component mounting. All other components can be assembled on the pcb surface.

The length of the connector contacts should be such that they protrude by no more than 1.5 millimetres after insertion to the pcb. Each contact collects solder on its tip as it penetrates the solder paster in the hole. So if the contact is too long, this solder would no longer be able to reflow back into the plated through hole by capillary action during the soldering process, therefore the quality of the soldered connection would suffer as a result.

Soldering instructions

The connectors should be protected when being soldered. Otherwise, they might become contaminated as a result of soldering operations or deformed as a result of overheating.

- 1) For prototypes and short runs protect the connectors with an industrial adhesive tape, e.g. Tesaband 4331 (www.tesa.de). Cover the underside of the connector moulding and the adjacent parts of the pcb as well as the open sides of the connector. This will prevent heat and gases of the soldering apparatus from damaging the connector. About 140 + 5 mm of the tape should suffice.
- 2) For large series a jig is recommended. Its protective cover with a fast action mechanical locking device shields the connectors from gas and heat generated by the soldering apparatus. As an additional protection a foil can be used for covering the parts that should not be soldered.
- 3) For prototypes and short runs the protection described under point 1) can be replaced by a solder protection cap. This cap can be ordered under the part no. 09 02 000 9935.

Mating conditions

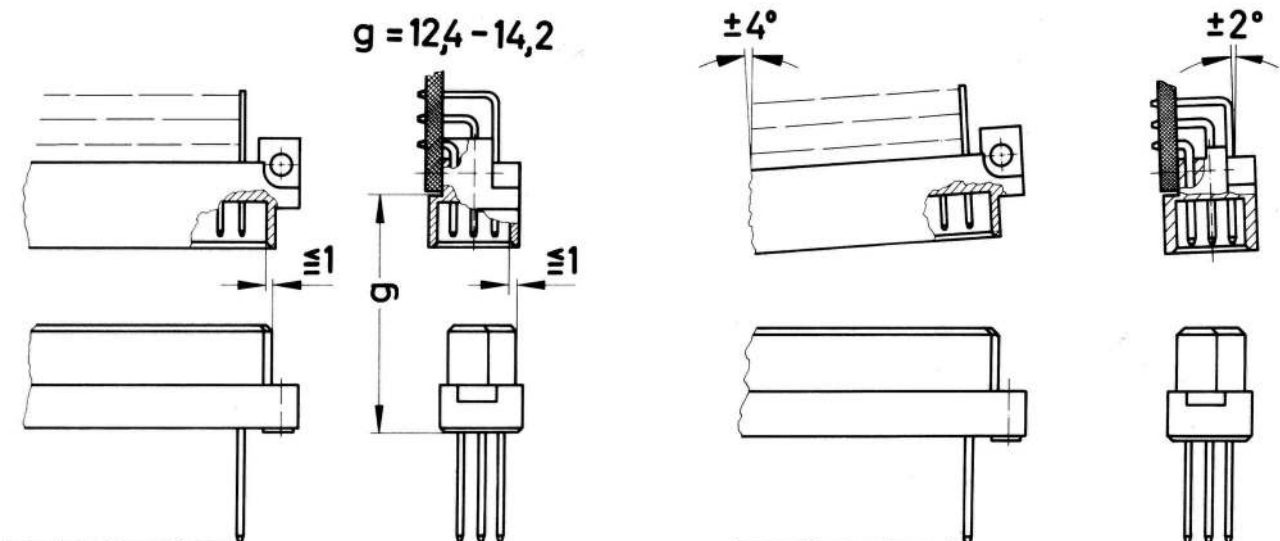

To ensure reliable connections and prevent unnecessary damage, please refer to the application data diagrams.

These recommendations are set out in IEC 60603-2.

The connectors should not be coupled and decoupled under electrical load.