

**Features**

- Advanced Process Technology
- Key Parameters Optimized for Class-D Audio Amplifier Applications
- Low  $R_{DS(ON)}$  for Improved Efficiency
- Low  $Q_g$  and  $Q_{sw}$  for Better THD and Improved Efficiency
- Low  $Q_{rr}$  for Better THD and Lower EMI
- 175°C Operating Junction Temperature for Ruggedness
- Repetitive Avalanche Capability for Robustness and Reliability
- Multiple Package Options

| Key Parameters                      |     |    |
|-------------------------------------|-----|----|
| $V_{DS}$                            | 55  | V  |
| $R_{DS(ON)}$ typ. @ $V_{GS} = 10V$  | 42  | mΩ |
| $R_{DS(ON)}$ typ. @ $V_{GS} = 4.5V$ | 57  | mΩ |
| $Q_g$ typ.                          | 28  | nC |
| $T_J$ max                           | 175 | °C |

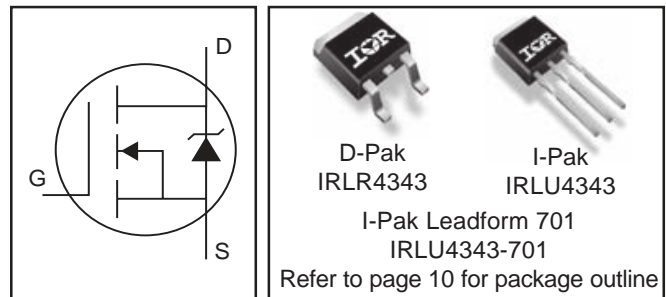

**Description**

This Digital Audio HEXFET<sup>®</sup> is specifically designed for Class-D audio amplifier applications. This MosFET utilizes the latest processing techniques to achieve low on-resistance per silicon area. Furthermore, Gate charge, body-diode reverse recovery and internal Gate resistance are optimized to improve key Class-D audio amplifier performance factors such as efficiency, THD and EMI. Additional features of this MosFET are 175°C operating junction temperature and repetitive avalanche capability. These features combine to make this MosFET a highly efficient, robust and reliable device for Class-D audio amplifier applications.

**Absolute Maximum Ratings**

|                             | Parameter                                | Max.         | Units |
|-----------------------------|--|--------------|-------|
| $V_{DS}$                    | Drain-to-Source Voltage                  | 55           | V     |
| $V_{GS}$                    | Gate-to-Source Voltage                   | ±20          |       |
| $I_D$ @ $T_C = 25^\circ C$  | Continuous Drain Current, $V_{GS}$ @ 10V | 26           | A     |
| $I_D$ @ $T_C = 100^\circ C$ | Continuous Drain Current, $V_{GS}$ @ 10V | 19           |       |
| $I_{DM}$                    | Pulsed Drain Current ①                   | 80           |       |
| $P_D$ @ $T_C = 25^\circ C$  | Power Dissipation                        | 79           | W     |
| $P_D$ @ $T_C = 100^\circ C$ | Power Dissipation                        | 39           |       |
|                             | Linear Derating Factor                   | 0.53         | W/°C  |
| $T_J$                       | Operating Junction and                   | -40 to + 175 | °C    |
| $T_{STG}$                   | Storage Temperature Range                |              |       |
|                             | Clamping Pressure ⑥                      | —            | N     |

**Thermal Resistance**

|                 | Parameter                            | Typ. | Max. | Units |
|-----------------|--------------------------------------|------|------|-------|
| $R_{\theta JC}$ | Junction-to-Case ⑤                   | —    | 1.9  | °C/W  |
| $R_{\theta JA}$ | Junction-to-Ambient (PCB Mounted) ⑤⑧ | —    | 50   |       |
| $R_{\theta JA}$ | Junction-to-Ambient (free air) ⑤     | —    | 110  |       |

Notes ① through ⑩ are on page 10

## Electrical Characteristics @ $T_J = 25^\circ\text{C}$ (unless otherwise specified)

|                                | Parameter                                 | Min. | Typ. | Max. | Units | Conditions   |
|--------------------------------|---|------|------|------|-------|--|
| $BV_{DSS}$                     | Drain-to-Source Breakdown Voltage         | 55   | —    | —    | V     | $V_{GS} = 0V, I_D = 250\mu A$                        |
| $\Delta BV_{DSS}/\Delta T_J$   | Breakdown Voltage Temp. Coefficient       | —    | 15   | —    | mV/°C | Reference to $25^\circ\text{C}, I_D = 1\text{mA}$    |
| $R_{DS(on)}$                   | Static Drain-to-Source On-Resistance      | —    | 42   | 50   | mΩ    | $V_{GS} = 10V, I_D = 4.7A$ ③                         |
|                                |   | —    | 57   | 65   |       | $V_{GS} = 4.5V, I_D = 3.8A$ ③                        |
| $V_{GS(th)}$                   | Gate Threshold Voltage                    | 1.0  | —    | —    | V     | $V_{DS} = V_{GS}, I_D = 250\mu A$                    |
| $\Delta V_{GS(th)}/\Delta T_J$ | Gate Threshold Voltage Coefficient        | —    | -4.4 | —    | mV/°C |  |
| $I_{DSS}$                      | Drain-to-Source Leakage Current           | —    | —    | 2.0  | μA    | $V_{DS} = 55V, V_{GS} = 0V$                          |
|                                |   | —    | —    | 25   |       | $V_{DS} = 55V, V_{GS} = 0V, T_J = 125^\circ\text{C}$ |
| $I_{GSS}$                      | Gate-to-Source Forward Leakage            | —    | —    | 100  | nA    | $V_{GS} = 20V$                                       |
|                                | Gate-to-Source Reverse Leakage            | —    | —    | -100 |       | $V_{GS} = -20V$                                      |
| $g_{fs}$                       | Forward Transconductance                  | 8.8  | —    | —    | S     | $V_{DS} = 25V, I_D = 19A$                            |
| $Q_g$                          | Total Gate Charge                         | —    | 28   | 42   |       | $V_{DS} = 44V$                                       |
| $Q_{gs}$                       | Pre-V <sub>th</sub> Gate-to-Source Charge | —    | 3.5  | —    |       | $V_{GS} = 10V$                                       |
| $Q_{gd}$                       | Gate-to-Drain Charge                      | —    | 9.5  | —    |       | $I_D = 19A$  |
| $Q_{godr}$                     | Gate Charge Overdrive                     | —    | 15   | —    |       | See Fig. 6 and 19                                    |
| $t_{d(on)}$                    | Turn-On Delay Time                        | —    | 5.7  | —    | ns    | $V_{DD} = 28V, V_{GS} = 10V$ ③                       |
| $t_r$                          | Rise Time                                 | —    | 19   | —    |       | $I_D = 19A$  |
| $t_{d(off)}$                   | Turn-Off Delay Time                       | —    | 23   | —    |       | $R_G = 2.5\Omega$                                    |
| $t_f$                          | Fall Time                                 | —    | 5.3  | —    |       |  |
| $C_{iss}$                      | Input Capacitance                         | —    | 740  | —    | pF    | $V_{GS} = 0V$  |
| $C_{oss}$                      | Output Capacitance                        | —    | 150  | —    |       | $V_{DS} = 50V$                                       |
| $C_{riss}$                     | Reverse Transfer Capacitance              | —    | 59   | —    |       | $f = 1.0\text{MHz}$ , See Fig.5                      |
| $C_{oss}$                      | Effective Output Capacitance              | —    | 250  | —    |       | $V_{GS} = 0V, V_{DS} = 0V$ to $-44V$                 |
| $L_D$                          | Internal Drain Inductance                 | —    | 4.5  | —    | nH    | Between lead,<br>6mm (0.25in.)                       |
| $L_S$                          | Internal Source Inductance                | —    | 7.5  | —    |       | from package<br>and center of die contact ④          |

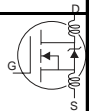

## Avalanche Characteristics

|          | Parameter                       | Typ.                      | Max. | Units |
|----------|---------------------------------|---------------------------|------|-------|
| $E_{AS}$ | Single Pulse Avalanche Energy ② | —                         | 160  | mJ    |
| $I_{AR}$ | Avalanche Current ⑦             | See Fig. 14, 15, 17a, 17b |      | A     |
| $E_{AR}$ | Repetitive Avalanche Energy ⑦   |                           |      | mJ    |

## Diode Characteristics

|                                | Parameter                              | Min. | Typ. | Max. | Units | Conditions   |
|--------------------------------|--|------|------|------|-------|--|
| $I_S @ T_C = 25^\circ\text{C}$ | Continuous Source Current (Body Diode) | —    | —    | 26   | A     | MOSFET symbol showing the integral reverse p-n junction diode. |
| $I_{SM}$                       | Pulsed Source Current (Body Diode) ①   | —    | —    | 80   |       |  |
| $V_{SD}$                       | Diode Forward Voltage                  | —    | —    | 1.2  | V     | $T_J = 25^\circ\text{C}, I_S = 19A, V_{GS} = 0V$ ③             |
| $t_{rr}$                       | Reverse Recovery Time                  | —    | 52   | 78   | ns    | $T_J = 25^\circ\text{C}, I_F = 19A$                            |
| $Q_{rr}$                       | Reverse Recovery Charge                | —    | 100  | 150  | nC    | $di/dt = 100A/\mu s$ ③   |

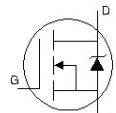

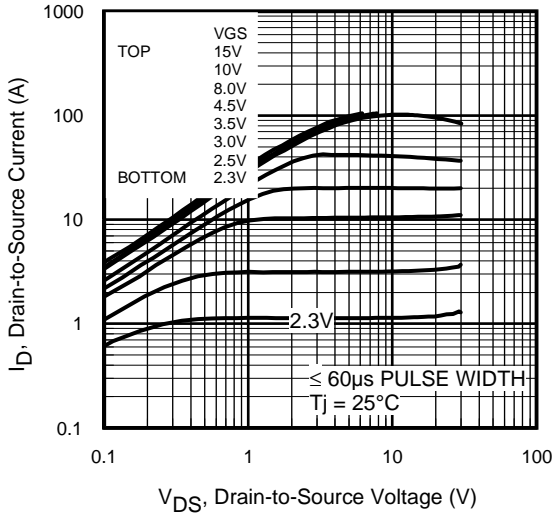

Fig 1. Typical Output Characteristics

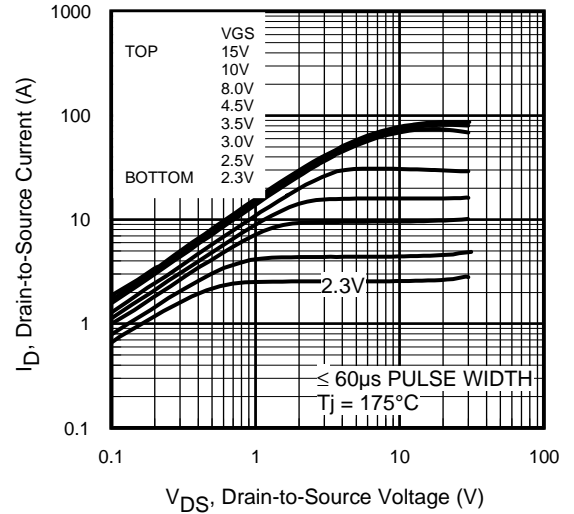

Fig 2. Typical Output Characteristics

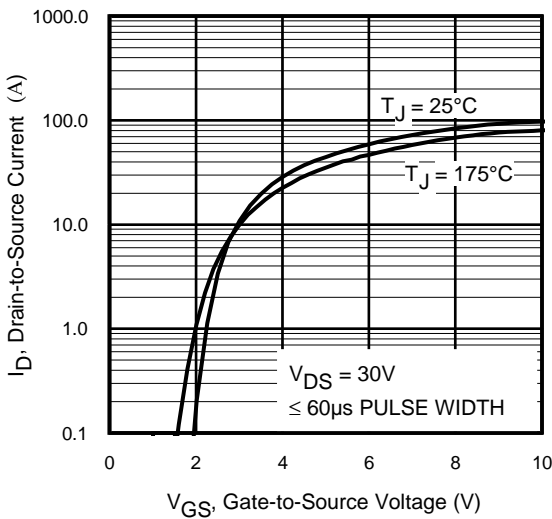

Fig 3. Typical Transfer Characteristics

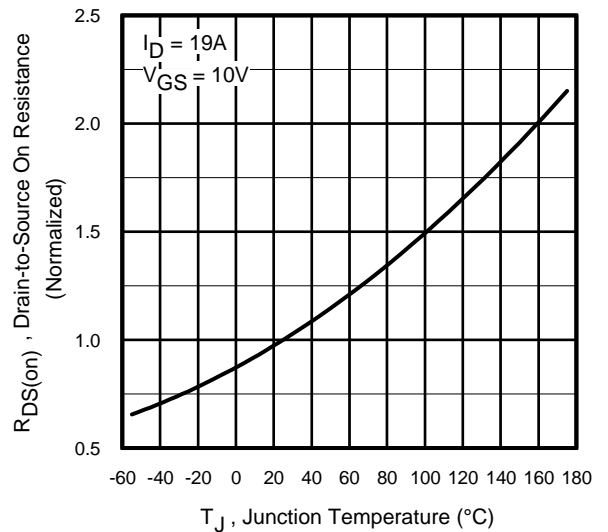

Fig 4. Normalized On-Resistance vs. Temperature

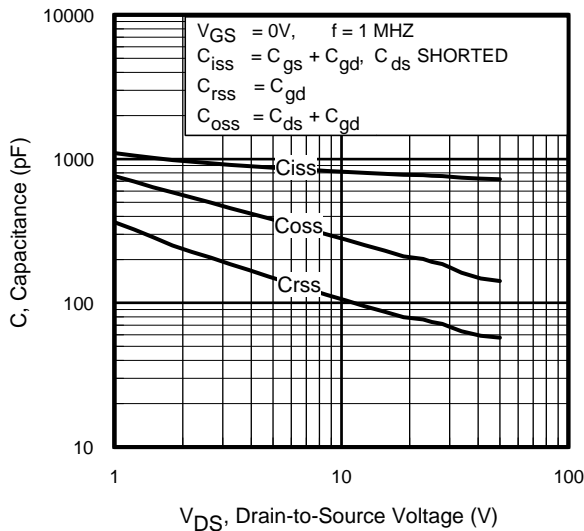

Fig 5. Typical Capacitance vs. Drain-to-Source Voltage  
www.irf.com

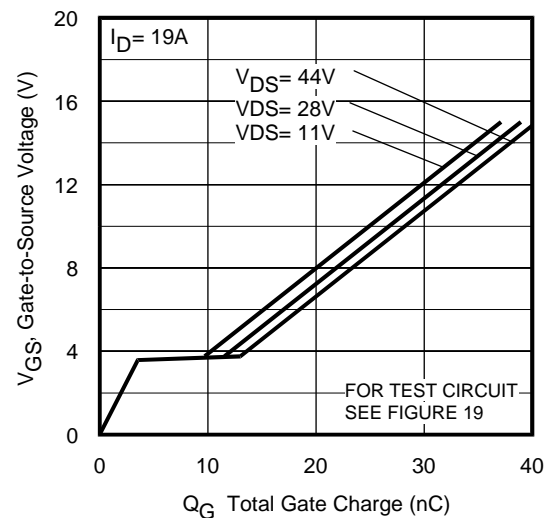
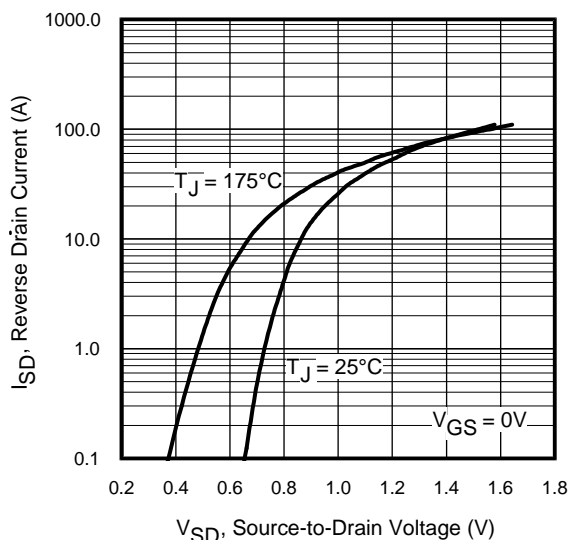
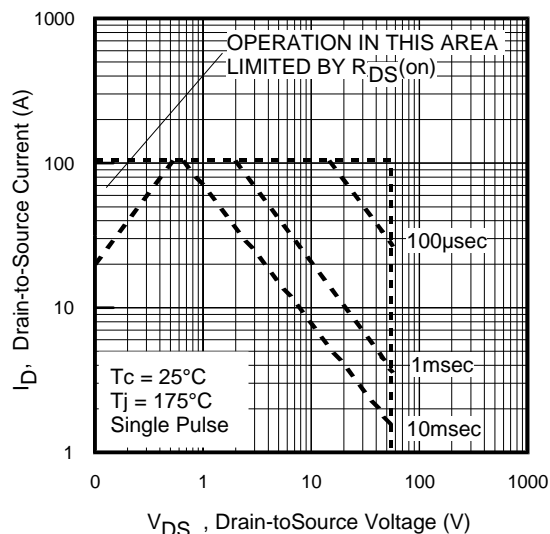

Fig 6. Typical Gate Charge vs. Gate-to-Source Voltage  
3



**Fig 7.** Typical Source-Drain Diode Forward Voltage



**Fig 8.** Maximum Safe Operating Area

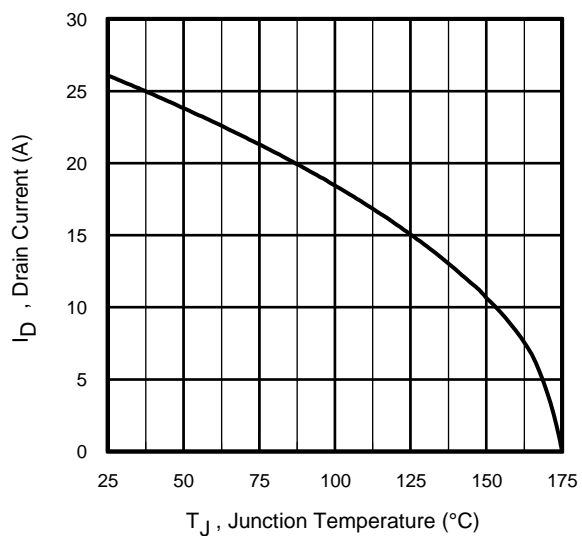

**Fig 9.** Maximum Drain Current vs. Case Temperature

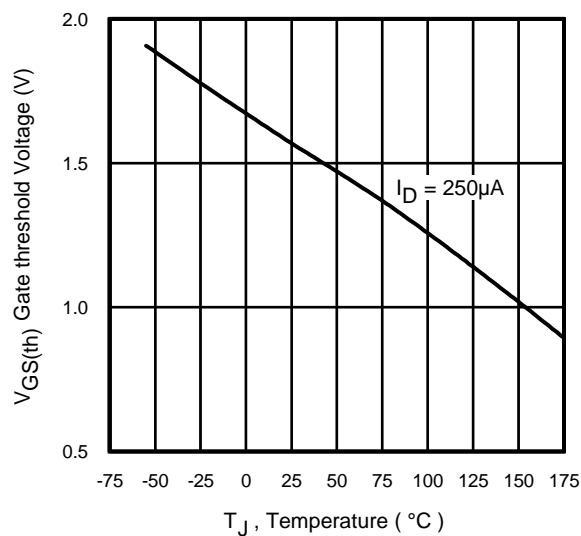

**Fig 10.** Threshold Voltage vs. Temperature

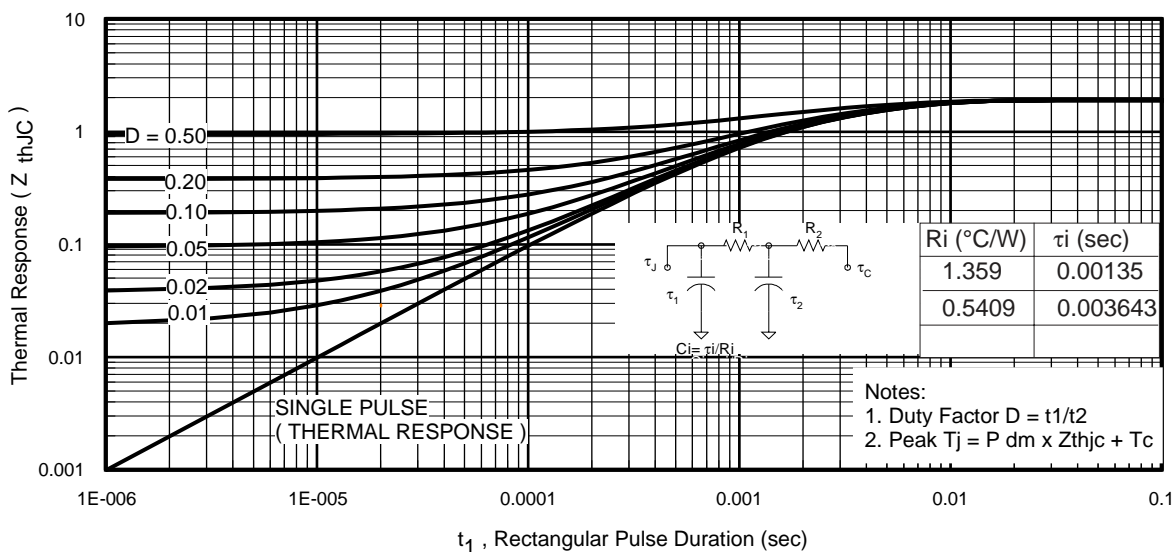

**Fig 11.** Maximum Effective Transient Thermal Impedance, Junction-to-Case

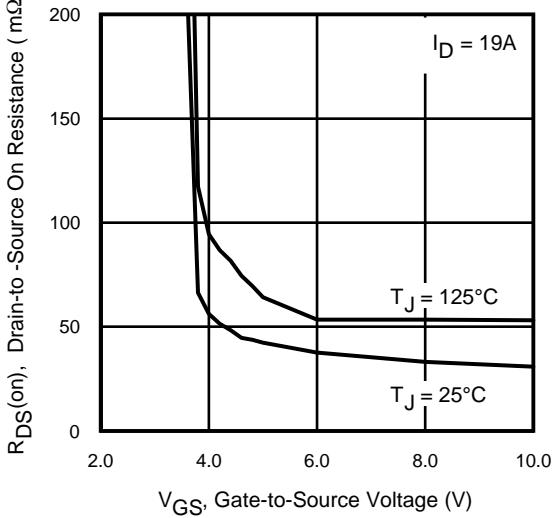

Fig 12. On-Resistance Vs. Gate Voltage

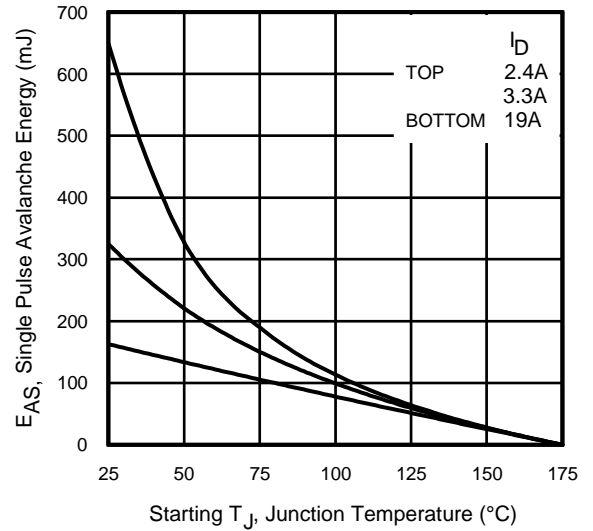

Fig 13. Maximum Avalanche Energy Vs. Drain Current

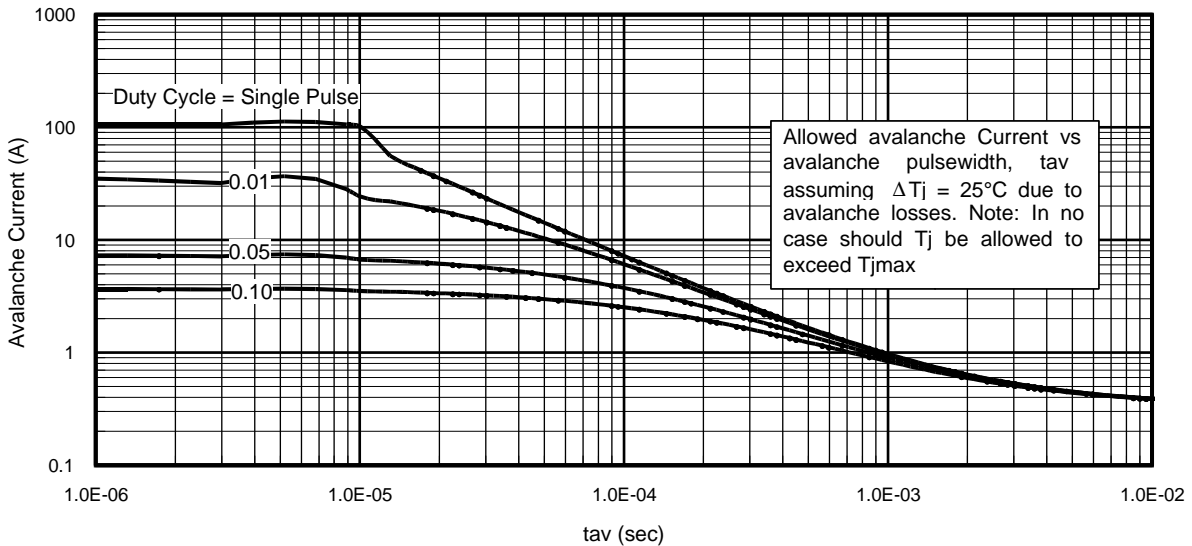

Fig 14. Typical Avalanche Current Vs. Pulsewidth

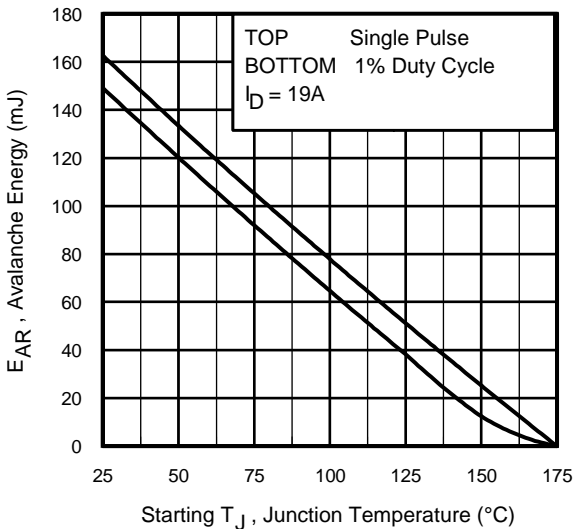

Fig 15. Maximum Avalanche Energy Vs. Temperature

**Notes on Repetitive Avalanche Curves , Figures 14, 15:**  
**(For further info, see AN-1005 at www.irf.com)**

1. Avalanche failures assumption:  
Purely a thermal phenomenon and failure occurs at a temperature far in excess of  $T_{jmax}$ . This is validated for every part type.
2. Safe operation in Avalanche is allowed as long as  $T_{jmax}$  is not exceeded.
3. Equation below based on circuit and waveforms shown in Figures 17a, 17b.
4.  $P_{D(ave)}$  = Average power dissipation per single avalanche pulse.
5. BV = Rated breakdown voltage (1.3 factor accounts for voltage increase during avalanche).
6.  $I_{av}$  = Allowable avalanche current.
7.  $\Delta T$  = Allowable rise in junction temperature, not to exceed  $T_{jmax}$  (assumed as 25°C in Figure 14, 15).  
 $t_{av}$  = Average time in avalanche  
 $D$  = Duty cycle in avalanche =  $t_{av} \cdot f$   
 $Z_{thJC}(D, t_{av})$  = Transient thermal resistance, see figure 11)

$$P_{D(ave)} = 1/2 ( 1.3 \cdot BV \cdot I_{av} ) = \Delta T / Z_{thJC}$$

$$I_{av} = 2\Delta T / [1.3 \cdot BV \cdot Z_{thJC}]$$

$$E_{AS(AR)} = P_{D(ave)} \cdot t_{av}$$

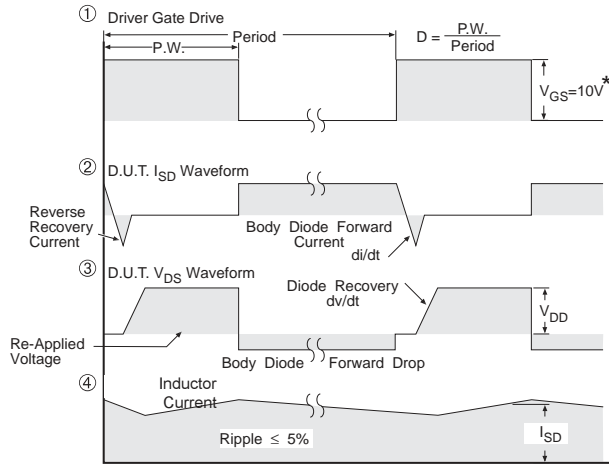
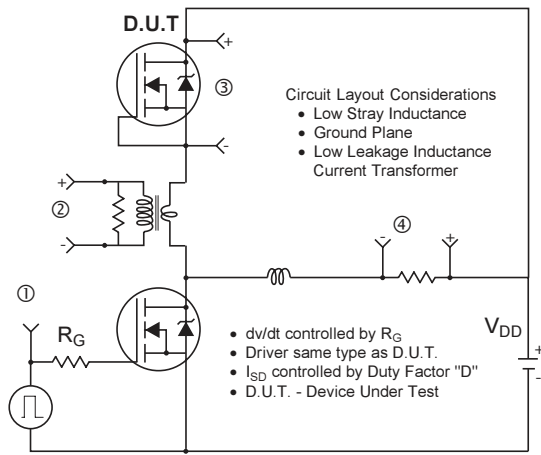

\*  $V_{GS} = 5V$  for Logic Level Devices

**Fig 16. Peak Diode Recovery  $dv/dt$  Test Circuit for N-Channel HEXFET<sup>®</sup> Power MOSFETs**

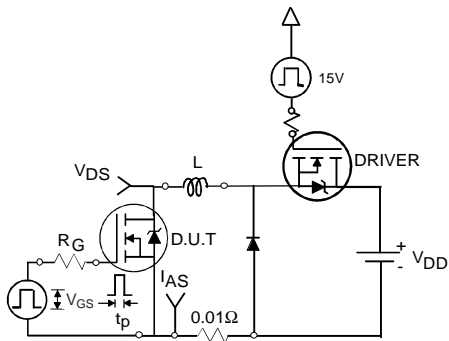

**Fig 17a. Unclamped Inductive Test Circuit**

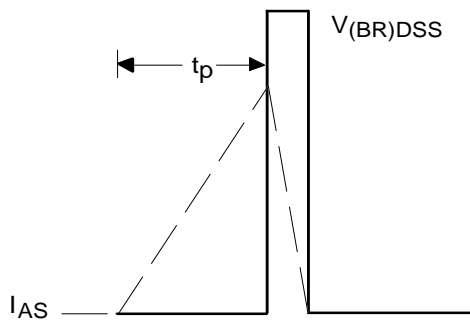

**Fig 17b. Unclamped Inductive Waveforms**

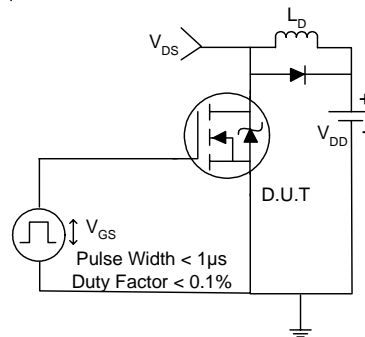

**Fig 18a. Switching Time Test Circuit**

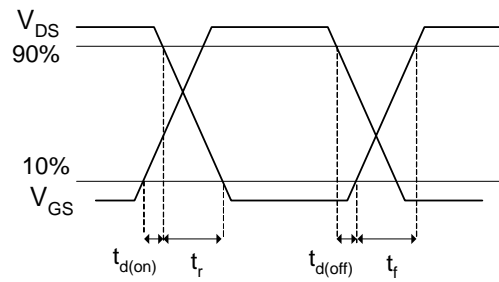

**Fig 18b. Switching Time Waveforms**

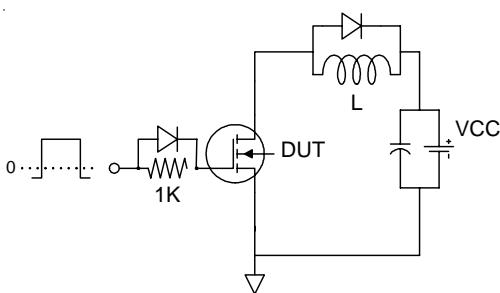

**Fig 19a. Gate Charge Test Circuit**

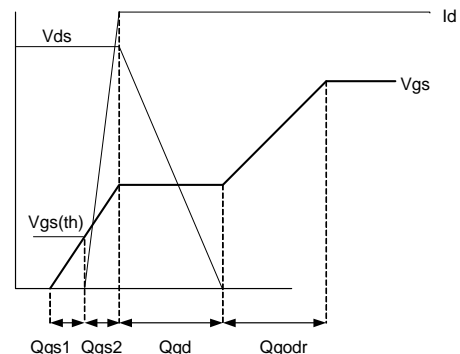

**Fig 19b Gate Charge Waveform**

## D-Pak (TO-252AA) Package Outline

Dimensions are shown in millimeters (inches)

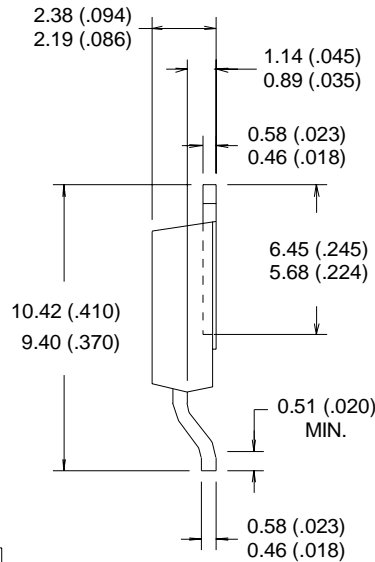
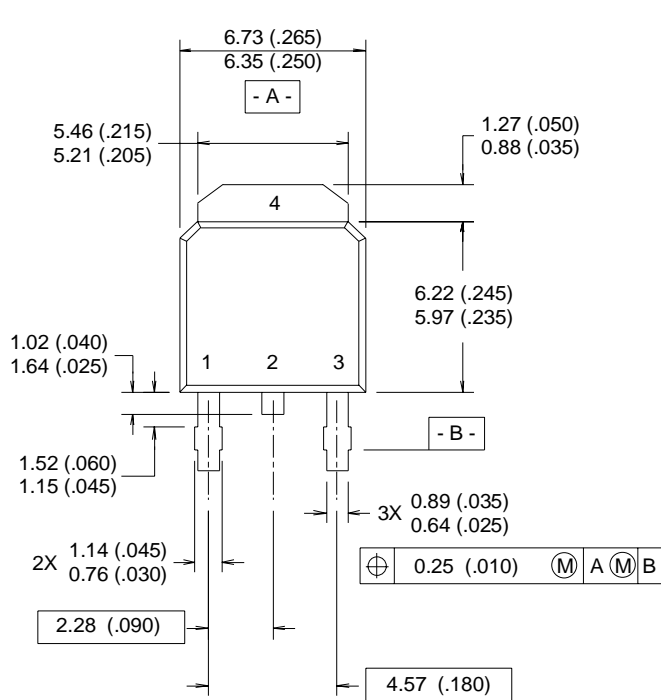

### LEAD ASSIGNMENTS

- 1 - GATE
- 2 - DRAIN
- 3 - SOURCE
- 4 - DRAIN

### NOTES:

- 1 DIMENSIONING & TOLERANCING PER ANSI Y14.5M, 1982.
- 2 CONTROLLING DIMENSION : INCH.
- 3 CONFORMS TO JEDEC OUTLINE TO-252AA.
- 4 DIMENSIONS SHOWN ARE BEFORE SOLDER DIP, SOLDER DIP MAX. +0.16 (.006).

## D-Pak (TO-252AA) Part Marking Information

Notes: This part marking information applies to devices produced before 02/26/2001

EXAMPLE: THIS IS AN IFR120  
WITH ASSEMBLY  
LOT CODE 9U1P

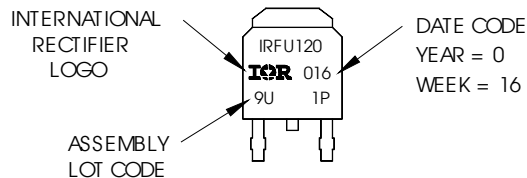

Notes: This part marking information applies to devices produced after 02/26/2001

EXAMPLE: THIS IS AN IFR120  
WITH ASSEMBLY  
LOT CODE 1234  
ASSEMBLED ON WW 16, 1999  
IN THE ASSEMBLY LINE "A"

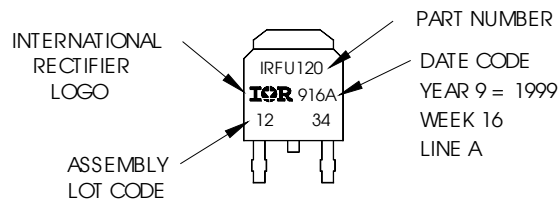

## I-Pak (TO-251AA) Package Outline

Dimensions are shown in millimeters (inches)

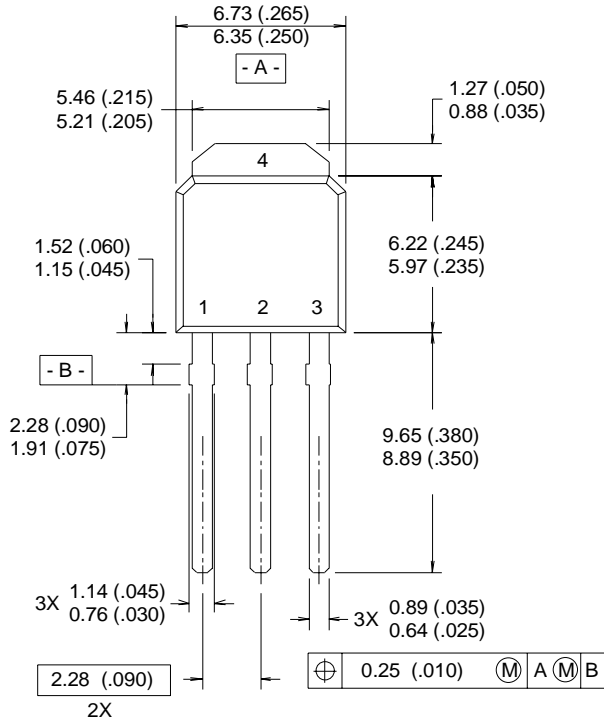

### LEAD ASSIGNMENTS

- 1 - GATE
- 2 - DRAIN
- 3 - SOURCE
- 4 - DRAIN

### NOTES:

- 1 DIMENSIONING & TOLERANCING PER ANSI Y14.5M, 1982.
- 2 CONTROLLING DIMENSION : INCH.
- 3 CONFORMS TO JEDEC OUTLINE TO-252AA.
- 4 DIMENSIONS SHOWN ARE BEFORE SOLDER DIP, SOLDER DIP MAX. +0.16 (.006).

## I-Pak (TO-251AA) Part Marking Information

Notes: This part marking information applies to devices produced before 02/26/2001

EXAMPLE: THIS IS AN IRFR120  
WITH ASSEMBLY  
LOT CODE 9U1P

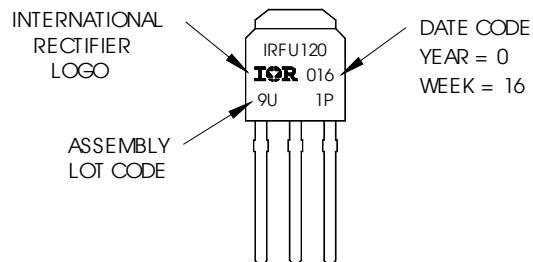

Notes: This part marking information applies to devices produced after 02/26/2001

EXAMPLE: THIS IS AN IRFR120  
WITH ASSEMBLY  
LOT CODE 5678  
ASSEMBLED ON WW 19, 1999  
IN THE ASSEMBLY LINE "A"

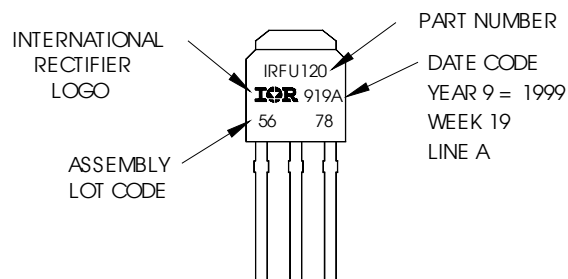



## D-Pak (TO-252AA) Tape & Reel Information

Dimensions are shown in millimeters (inches)

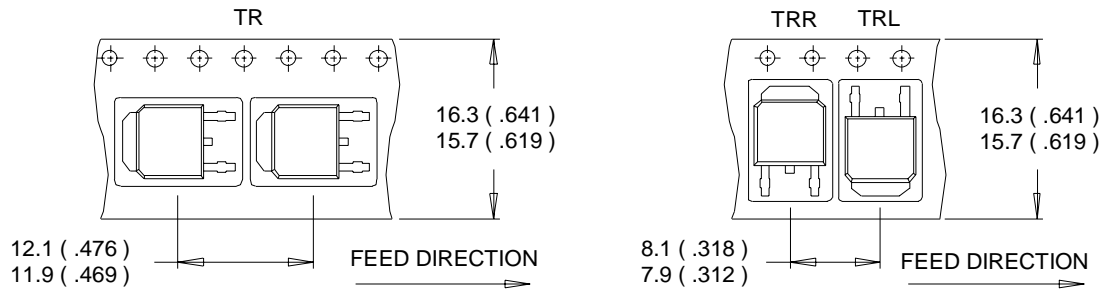

**NOTES :**

1. CONTROLLING DIMENSION : MILLIMETER.
2. ALL DIMENSIONS ARE SHOWN IN MILLIMETERS ( INCHES ).
3. OUTLINE CONFORMS TO EIA-481 & EIA-541.

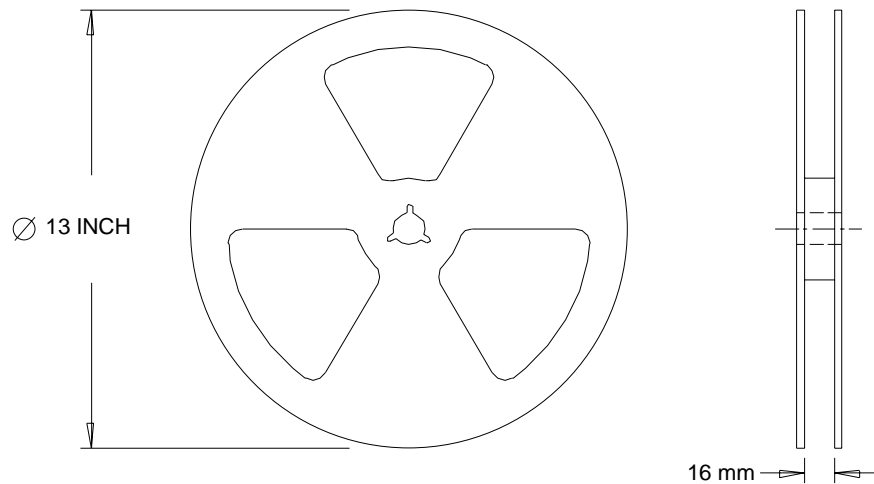

**NOTES :**

1. OUTLINE CONFORMS TO EIA-481.

# IRLR/U4343 & IRLU4343-701

## I-Pak Leadform Option 701 Package Outline ⑨

Dimensions are shown in millimeters (inches)

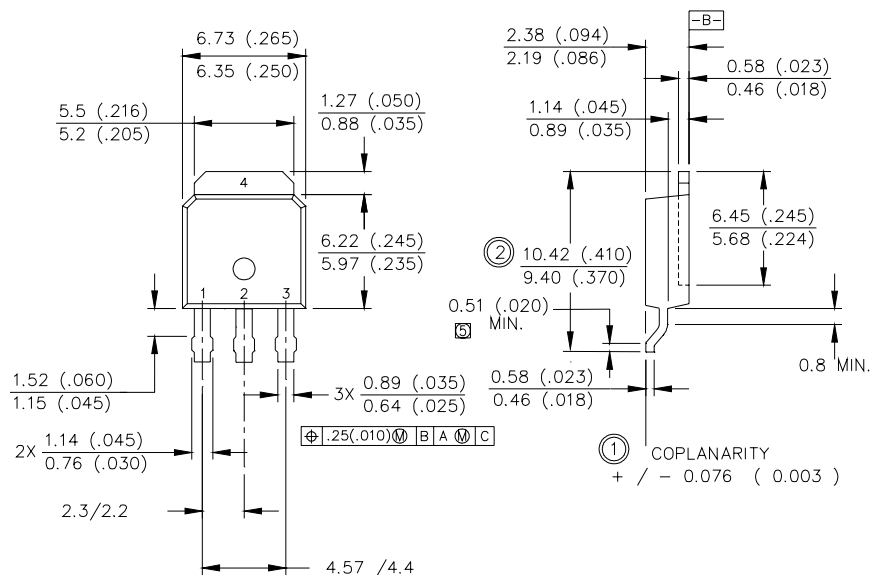

- 1-. GATE
- 2-. DRAIN
- 3-. SOURCE
- 4-. DRAIN

### NOTES:

- 1.0 CONTROL DIMENSIONS IN INCHES
- 2.0 PARALLELISM AND ANGULARITY MAX. 0.076 (0.003)
- 3.0 LEADFORM CRITICAL DIMENSIONS DOUBLE RINGED

### Notes:

- ① Repetitive rating; pulse width limited by max. junction temperature.
- ② Starting  $T_J = 25^\circ\text{C}$ ,  $L = 0.93\text{mH}$ ,  $R_G = 25\Omega$ ,  $I_{AS} = 19\text{A}$ .
- ③ Pulse width  $\leq 400\mu\text{s}$ ; duty cycle  $\leq 2\%$ .
- ④ This only applies for I-Pak,  $L_S$  of D-Pak is measured between lead and center of die contact
- ⑤  $R_\theta$  is measured at  $T_J$  of approximately  $90^\circ\text{C}$ .
- ⑥ Contact factory for mounting information
- ⑦ Limited by  $T_{jmax}$ . See Figs. 14, 15, 17a, 17b for repetitive avalanche information
- ⑧ When D-Pak mounted on 1" square PCB (FR-4 or G-10 Material) . For recommended footprint and soldering techniques refer to application note #AN-994
- ⑨ Refer to D-Pak package for Part Marking, Tape and Reel information.

Data and specifications subject to change without notice.  
This product has been designed for the Industrial market.  
Qualification Standards can be found on IR's Web site.

International  
**IR** Rectifier

IR WORLD HEADQUARTERS: 233 Kansas St., El Segundo, California 90245, USA Tel: (310) 252-7105  
TAC Fax: (310) 252-7903

Visit us at [www.irf.com](http://www.irf.com) for sales contact information.3/04

[www.irf.com](http://www.irf.com)

Note: For the most current drawings please refer to the IR website at:  
<http://www.irf.com/package/>