

74F158A Quad 2-Input Multiplexer

General Description

The F158A is a high speed quad 2-input multiplexer. It selects four bits of data from two sources using the common Select and Enable inputs. The four outputs present the selected data in the inverted form. The F158A can also generate any four of the 16 different functions of two variables.

Ordering Code:

Order Number	Package Number	Package Description
74F158ASC (Note 1)	M16A	16-Lead Small Outline Integrated Circuit (SOIC), JEDEC MS-012, 0.150" Narrow
74F158ASJ	M16D	16-Lead Small Outline Package (SOP), EIAJ TYPE II, 5.3mm Wide
74F158APC	N16E	16-Lead Plastic Dual-In-Line Package (PDIP), JEDEC MS-001, 0.300" Wide

Note 1: Devices also available in Tape and Reel. Specify by appending the suffix letter "X" to the ordering code.

Logic Symbols

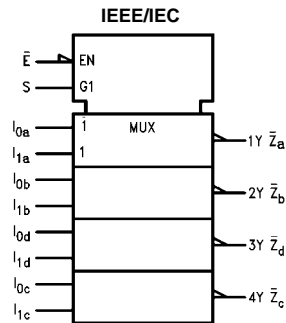
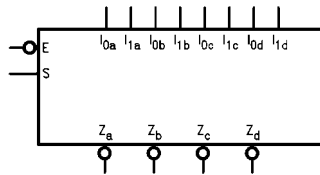

Connection Diagram

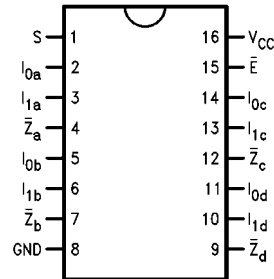

Unit Loading/Fan Out

Pin Names	Description	U.L.	
		HIGH/LOW	Input I_{IH}/I_{IL} Output I_{OH}/I_{OL}
$I_{0a}-I_{0d}$	Source 0 Data Inputs	1.0/1.0	20 μ A/-0.6 mA
$I_{1a}-I_{1d}$	Source 1 Data Inputs	1.0/1.0	20 μ A/-0.6 mA
\bar{E}	Enable Input (Active LOW)	1.0/1.0	20 μ A/-0.6 mA
S	Select Input	1.0/1.0	20 μ A/-0.6 mA
$\bar{Z}_a-\bar{Z}_d$	Inverted Outputs	50/33.3	-1 mA/20 mA

Truth Table

\bar{E}	Inputs			\bar{Z}
	S	I_0	I_1	
H	X	X	X	H
L	L	L	X	H
L	L	H	X	L
L	H	X	L	H
L	H	X	H	L

H = HIGH Voltage Level
L = LOW Voltage Level
X = Immaterial
 $\bar{Z}_n = \bar{E} \times (I_{1n}S + I_{0n}\bar{S})$

Functional Description

The F158A quad 2-input multiplexer selects four bits of data from two sources under the control of a common Select input (S) and presents the data in inverted form at the four outputs. The Enable input (\bar{E}) is active LOW. When \bar{E} is HIGH, all of the outputs (\bar{Z}) are forced HIGH regardless of all other inputs. The F158A is the logic implementation of a 4-pole, 2-position switch where the position of the switch is determined by the logic levels supplied to the Select input.

A common use of the F158A is the moving of data from two groups of registers to four common output busses. The particular register from which the data comes is determined by the state of the Select input. A less obvious use is as a function generator. The F158A can generate four functions of two variables with one variable common. This is useful for implementing gating functions.

Logic Diagram

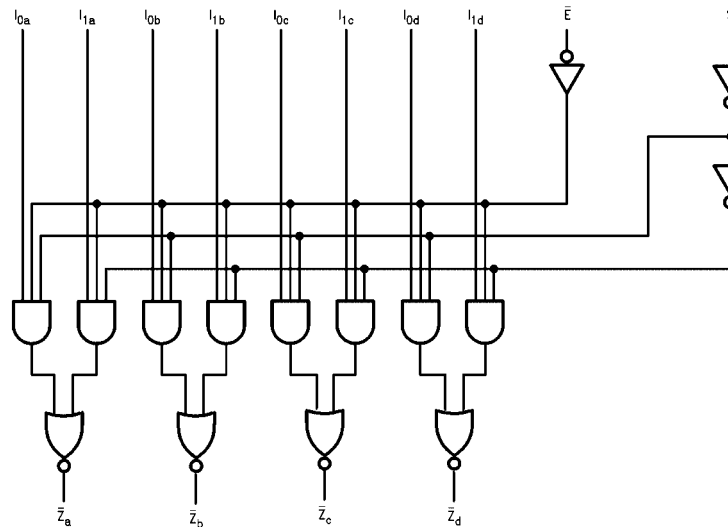

Please note that this diagram is provided only for the understanding of logic operations and should not be used to estimate propagation delays.

Absolute Maximum Ratings ^(Note 2)		Recommended Operating Conditions	
Storage Temperature	-65°C to +150°C	Free Air Ambient Temperature	0°C to +70°C
Ambient Temperature under Bias	-55°C to +125°C	Supply Voltage	+4.5V to +5.5V
Junction Temperature under Bias	-55°C to +150°C		
V _{CC} Pin Potential to Ground Pin	-0.5V to +7.0V		
Input Voltage (Note 3)	-0.5V to +7.0V		
Input Current (Note 3)	-30 mA to +5.0 mA		
Voltage Applied to Output in HIGH State (with V _{CC} = 0V)			
Standard Output	-0.5V to V _{CC}		
3-STATE Output	-0.5V to +5.5V		
Current Applied to Output in LOW State (Max)	twice the rated I _{OL} (mA)		
ESD Last Passing Voltage (Min)	4000V		

Note 2: Absolute maximum ratings are values beyond which the device may be damaged or have its useful life impaired. Functional operation under these conditions is not implied.

Note 3: Either voltage limit or current limit is sufficient to protect inputs.

DC Electrical Characteristics

Symbol	Parameter	Min	Typ	Max	Units	V _{CC}	Conditions
V _{IH}	Input HIGH Voltage	2.0			V		Recognized as a HIGH Signal
V _{IL}	Input LOW Voltage			0.8	V		Recognized as a LOW Signal
V _{CD}	Input Clamp Diode Voltage			-1.2	V	Min	I _{IN} = -18 mA
V _{OH}	Output HIGH Voltage	10% V _{CC} 5% V _{CC}	2.5 2.7		V	Min	I _{OH} = -1 mA I _{OH} = -1 mA
V _{OL}	Output LOW Voltage	10% V _{CC}		0.5	V	Min	I _{OL} = 20 mA
I _{IH}	Input HIGH Current			5.0	μA	Max	V _{IN} = 2.7V
I _{BVI}	Input HIGH Current Breakdown Test			7.0	μA	Max	V _{IN} = 7.0V
I _{CEX}	Output HIGH Leakage Current			50	μA	Max	V _{OUT} = V _{CC}
V _{ID}	Input Leakage Test	4.75			V	0.0	I _{ID} = 1.9 μA All Other Pins Grounded
I _{OD}	Output Leakage Circuit Current			3.75	μA	0.0	V _{IOD} = 150 mV All Other Pins Grounded
I _{IL}	Input LOW Current			-0.6	mA	Max	V _{IN} = 0.5V
I _{OS}	Output Short-Circuit Current	-60		-150	mA	Max	V _{OUT} = 0V
I _{CCH}	Power Supply Current		10	15	mA	Max	V _O = HIGH
I _{CCL}	Power Supply Current		15	25	mA	Max	V _O = LOW

AC Electrical Characteristics

Symbol	Parameter	T _A = +25°C V _{CC} = +5.0V C _L = 50 pF			T _A = -55°C to +125°C V _{CC} = +5.0V C _L = 50 pF		T _A = 0°C to +70°C V _{CC} = +5.0V C _L = 50 pF		Units
		Min	Typ	Max	Min	Max	Min	Max	
		t _{PLH}	Propagation Delay S to \bar{Z}_n	3.0	5.5	8.5	3.0	10.5	
t _{PHL}	S to \bar{Z}_n	2.5	4.5	6.5	2.5	8.0	2.5	7.0	ns
t _{PLH}	Propagation Delay \bar{E} to \bar{Z}_n	2.5	4.5	6.0	2.5	8.0	2.5	7.0	ns
t _{PHL}	\bar{E} to \bar{Z}_n	2.0	4.0	6.0	2.0	7.0	2.0	6.5	ns
t _{PLH}	Propagation Delay I _n to \bar{Z}_n	2.5	4.0	5.9	2.5	8.5	2.5	7.0	ns
t _{PHL}	I _n to \bar{Z}_n	1.5	2.5	4.0	1.0	5.0	1.5	4.5	ns

Physical Dimensions inches (millimeters) unless otherwise noted

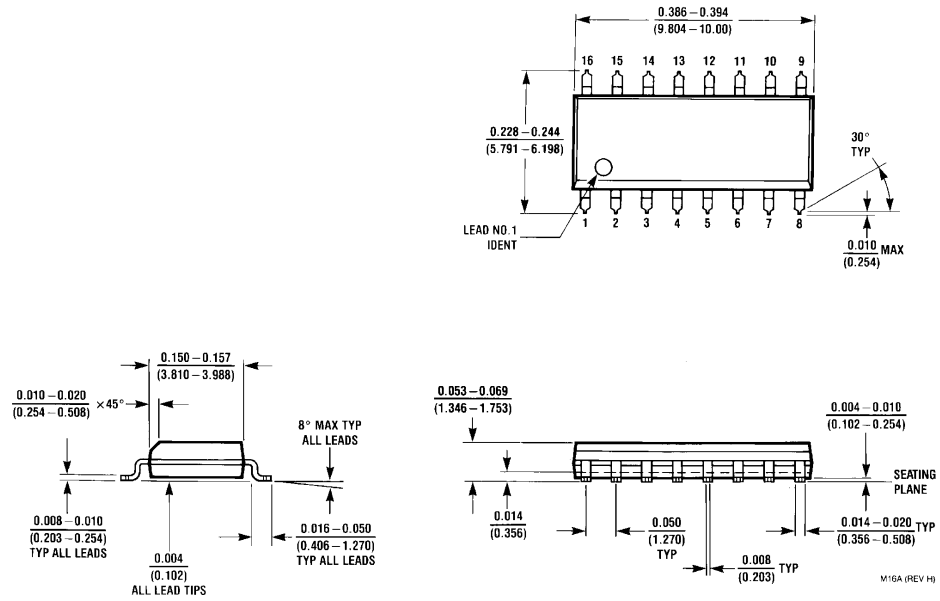

16-Lead Small Outline Integrated Circuit (SOIC), JEDEC MS-012, 0.150" Narrow Package Number M16A

Physical Dimensions inches (millimeters) unless otherwise noted (Continued)

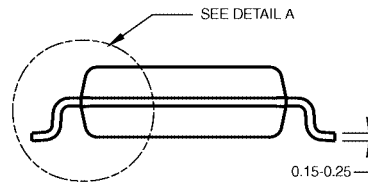
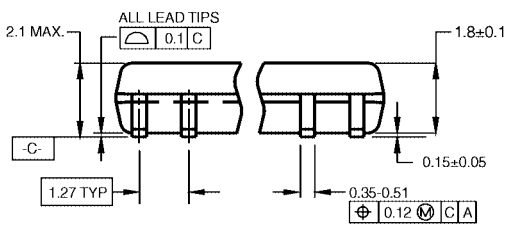
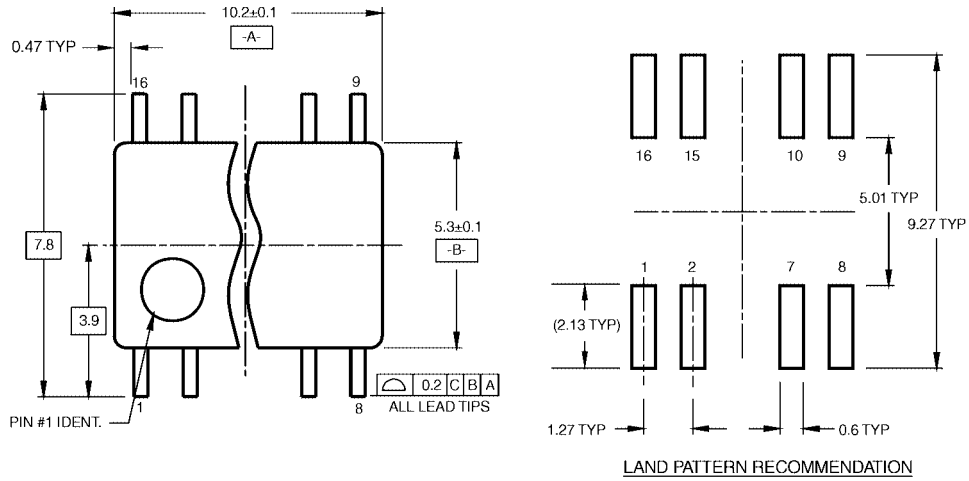

DIMENSIONS ARE IN MILLIMETERS

- NOTES:
 A. CONFORMS TO EIAJ EDR-7320 REGISTRATION, ESTABLISHED IN DECEMBER, 1998.
 B. DIMENSIONS ARE IN MILLIMETERS.
 C. DIMENSIONS ARE EXCLUSIVE OF BURRS, MOLD FLASH, AND TIE BAR EXTRUSIONS.

M16DRevB1



**16-Lead Small Outline Package (SOP), EIAJ TYPE II, 5.3mm Wide
 Package Number M16D**

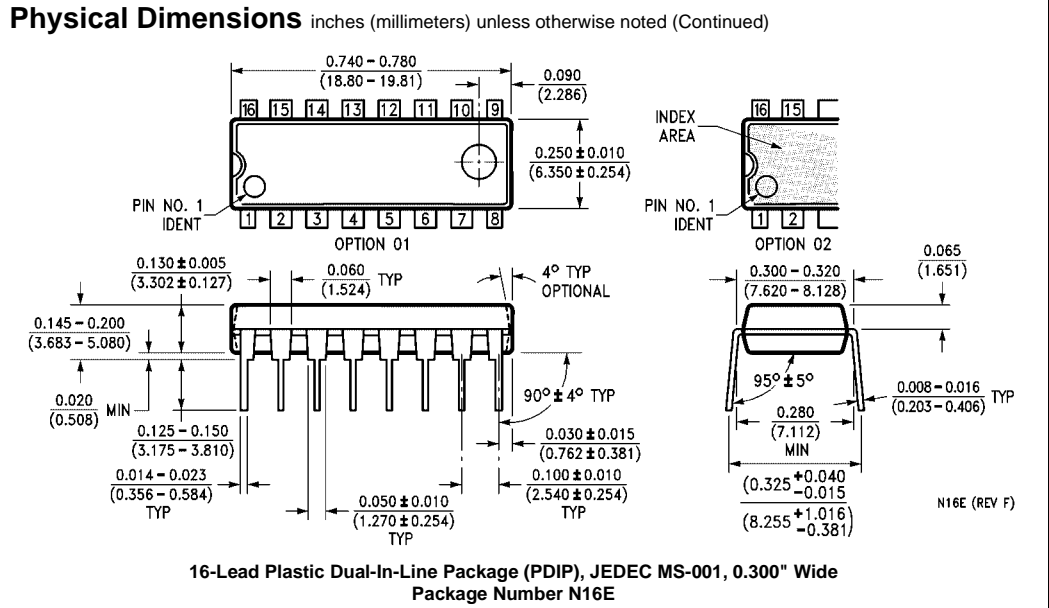

Fairchild does not assume any responsibility for use of any circuitry described, no circuit patent licenses are implied and Fairchild reserves the right at any time without notice to change said circuitry and specifications.

LIFE SUPPORT POLICY

FAIRCHILD'S PRODUCTS ARE NOT AUTHORIZED FOR USE AS CRITICAL COMPONENTS IN LIFE SUPPORT DEVICES OR SYSTEMS WITHOUT THE EXPRESS WRITTEN APPROVAL OF THE PRESIDENT OF FAIRCHILD SEMICONDUCTOR CORPORATION. As used herein:

1. Life support devices or systems are devices or systems which, (a) are intended for surgical implant into the body, or (b) support or sustain life, and (c) whose failure to perform when properly used in accordance with instructions for use provided in the labeling, can be reasonably expected to result in a significant injury to the user.
2. A critical component in any component of a life support device or system whose failure to perform can be reasonably expected to cause the failure of the life support device or system, or to affect its safety or effectiveness.

www.fairchildsemi.com