

SECTION A-A

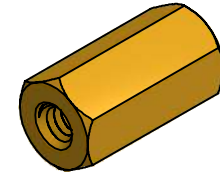

ISO SCALE 2 : 1

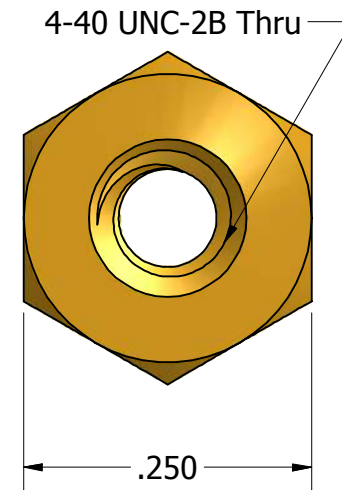
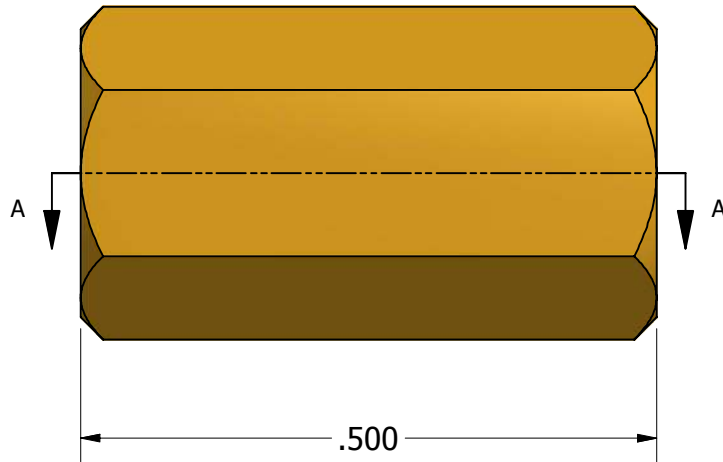

Tolerances Unless Otherwise Specified:

.xx Decimal: $\pm .02$
.xxx Decimal: $\pm .005$
Fraction: $\pm 1/64$
Angle: $\pm 2^\circ$

LYN-TRON, INC.

Part Number:

BR6951-0440-0.500

Description:

1/4 Hex Standoff

Drawn By:

COURTNEYS07/14/2010

Gauge:

Material:

Brass

Scale:

6 : 1