

MGB-TLB20-C

Planet® MGB-TLB20 Compatible TAA 1000Base-BX SFP Transceiver (SMF, 1490nmTx/1310nmRx, 10km, LC, DOM, -40 to 85C)

Features:

- INF-8074 and SFF-8472 Compliance
- Simplex LC Connector
- Single-mode Fiber
- Industrial Temperature -40 to 85 Celsius
- Hot Pluggable
- Metal with Lower EMI
- Excellent ESD Protection
- RoHS Compliant and Lead Free



Applications:

- 1000Base-BX Ethernet
- 1x Fibre Channel
- Access (FTTx) and Enterprise

Product Description

This Planet® MGB-TLB20 compatible SFP transceiver provides 1000Base-BX throughput up to 10km over single-mode fiber (SMF) using a wavelength of 1490nmTx/1310nmRx via an LC connector. It is guaranteed to be 100% compatible with the equivalent Planet® transceiver. This easy to install, hot swappable transceiver has been programmed, uniquely serialized and data-traffic and application tested to ensure that it will initialize and perform identically. Digital optical monitoring (DOM) support is also present to allow access to real-time operating parameters. This transceiver is Trade Agreements Act (TAA) compliant. We stand behind the quality of our products and proudly offer a limited lifetime warranty.

ProLabs' transceivers are RoHS compliant and lead-free.

TAA refers to the Trade Agreements Act (19 U.S.C. & 2501-2581), which is intended to foster fair and open international trade. TAA requires that the U.S. Government may acquire only "U.S. – made or designated country end products."



Regulatory Compliance

- ESD to the Electrical PINs: compatible with MIL-STD-883E Method 3015.4
- ESD to the LC Receptacle: compatible with IEC 61000-4-3
- EMI/EMC compatible with FCC Part 15 Subpart B Rules, EN55022:2010
- Laser Eye Safety compatible with FDA 21CFR, EN60950-1& EN (IEC) 60825-1,2
- RoHS compliant with EU RoHS 2.0 directive 2015/863/EU

Absolute Maximum Ratings

Parameter	Symbol	Min.	Typ.	Max.	Unit	Notes
Maximum Supply Voltage	V _{CC}	-0.5		4.0	V	1
Storage Temperature	T _S	-40		85	°C	2
Operating Case Temperature	T _C	-40		+85	°C	
Operating Humidity	RH	5		85	%	
Bit Error Rate	BER			10 ⁻¹²		
Data Rate	DR		1.25		Gbps	3
	DR		1.062		Gbps	4

Notes:

1. For electrical power interface
2. Ambient temperature
3. IEEE 802.3
4. FC-PI-2 Rev7.0

Electrical Characteristics (V_{CC}=3.14V to 3.46V, T_C=-40 °C to +85 °C)

Parameter	Symbol	Min.	Typ.	Max.	Unit	Notes
Power Supply Voltage	V _{CC}	3.14	3.3	3.46	V	
Power Supply Current	I _{CC}		200	300	mA	1
Transmitter						
Input differential impedance	R _{IN}		100		Ω	
Single ended data input swing	V _{IN_PP}	250		1200	mV	
Transmit disable voltage	V _D	V _{CC} -1.3		V _{CC}	V	
Transmit enable voltage	V _{EN}	V _{EE}		V _{EE} +0.8	V	
Transmit disable assert time				10	μs	
Receiver						
Single ended data output swing	V _{OUT_PP}	300	400	800	mV	
Data output rise/fall time (20%-80%)	t _r /t _f			300	ps	
LOS Assert	V _{LOS_A}	V _{CC} -0.5		V _{CC_HOST}	V	
LOS De-Assert	V _{LOS_D}	V _{EE}		V _{EE} +0.5	V	

Notes:

1. For electrical power interface

Optical Characteristics

Parameter	Symbol	Min.	Typ.	Max.	Unit	Notes
Transmitter						
Output Optical Power	PTX	-9		-3	dBm	1
Optical Center Wavelength	λ_c	1470	1490	1510	nm	
Optical Modulation Amplitude	OMA	174			μ W	2
Extinction Ratio	ER	9			dB	
Spectral Width (-20dB)	$\Delta\lambda$			1	nm	
Side Mode Suppression Ratio	SMSR	30				
Optical Rise/Fall Time (20%-80%)	t_r/t_f		150	260	ps	
Relative Intensity Noise	RIN			-120	dB/Hz	
Deterministic Jitter Contribution	DJ		30	60	ps	
Total Jitter Contribution	TJ		60	120	ps	
Receiver						
Receiver Overload	POL	-3			dBm	
Optical Center Wavelength	λ_c	1260		1360	nm	
Receiver Sensitivity @ 1.063Gb/s	RX_SEN1			-19.5	dBm	3
Receiver Sensitivity @ 1.25Gb/s	RX_SEN2			-19.5	dBm	4
Optical Return Loss	ORL	14			dB	
Optical Isolation	ISO	35			dB	
LOS Assert	LOS _A	-30			dBm	
LOS De-Assert	LOS _D			-24	dBm	
LOS Hysteresis	LOS _H	0.5			dB	

Notes:

1. Class 1 Product
2. Equivalent extinction ratio specification for FC
3. FC-PI-2 Rev7.0 2.
4. IEEE 802.3

Pin Descriptions

Pin	Symbol	Name/Descriptions	Ref.
1	VEET	Transmitter ground (common with receiver ground)	1
2	TX_FAULT	Transmitter Fault. Not supported	
3	TX_DISABLE	Transmitter Disable. Laser output disabled on high or open	2
4	MOD_DEF(2)	Module Definition 2. Data line for serial ID	3
5	MOD_DEF(1)	Module Definition 1. Clock line for serial ID	3
6	MOD_DEF(0)	Module Definition 0. Grounded within the module	3
7	Rate Select	No connection required	
8	LOS	Loss of Signal indication. Logic 0 indicates normal operation	4
9	VEER	Receiver ground (common with transmitter ground)	1
10	VEER	Receiver ground (common with transmitter ground)	1
11	VEER	Receiver ground (common with transmitter ground)	1
12	RD-	Receiver Inverted DATA out. AC coupled	
13	RD+	Receiver Non-inverted DATA out. AC coupled	
14	VEER	Receiver ground (common with transmitter ground)	1
15	VCCR	Receiver power supply	
16	VCCT	Transmitter power supply	
17	VEET	Transmitter ground (common with receiver ground)	1
18	TD+	Transmitter Non-Inverted DATA in. AC coupled	
19	TD-	Transmitter Inverted DATA in. AC coupled	
20	VEET	Transmitter ground (common with receiver ground)	1

Notes:

1. Circuit ground is isolated from chassis ground
2. Disabled: $T_{DIS} > 2V$ or open, Enabled: $T_{DIS} < 0.8V$
3. Should Be pulled up with 4.7k –10k ohm on host board to a voltage between 2V and 3.6V
4. LOS is open collector output

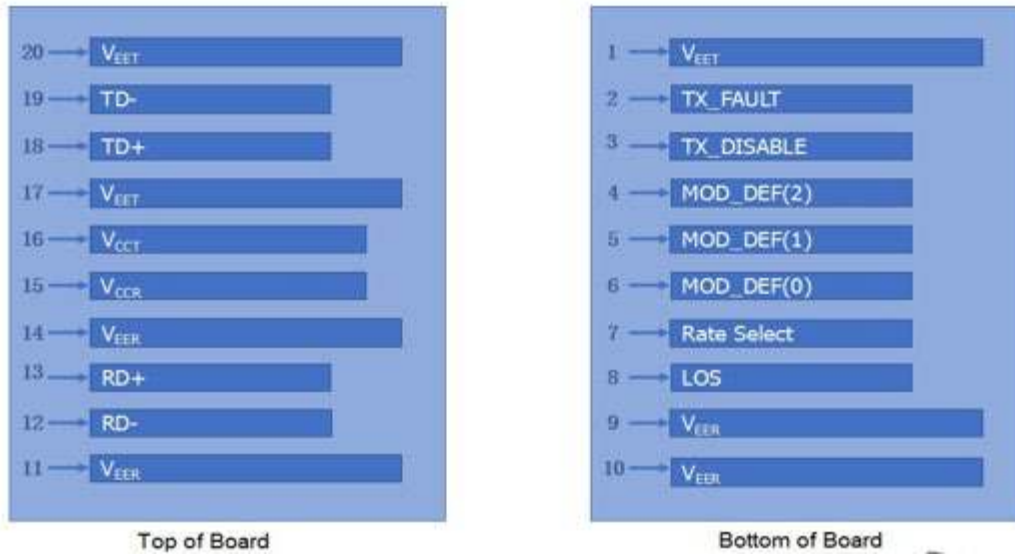

Pin-out of connector Block on Host board

Block Diagram of Transceiver

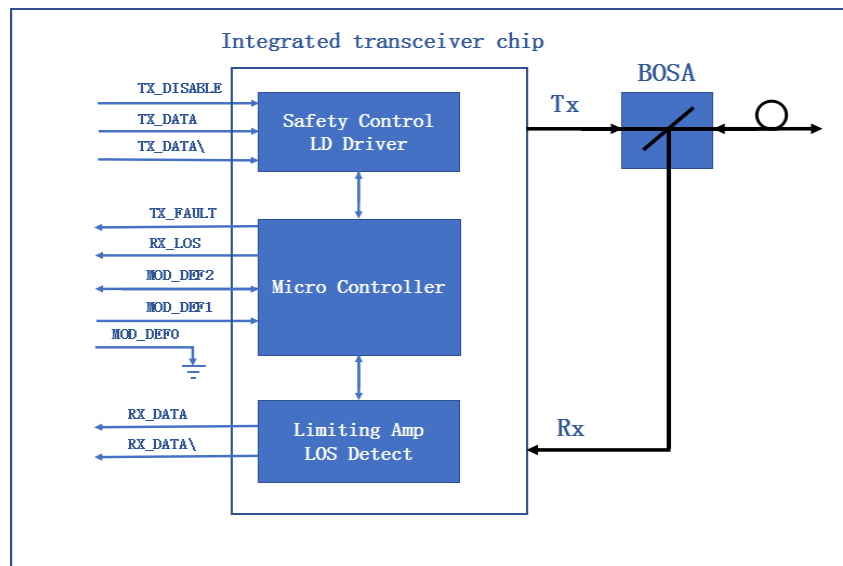

Mechanical Specifications

Small Form Factor Pluggable (SFP) transceivers are compatible with the dimensions defined by the SFP Multi-Sourcing Agreement (MSA).

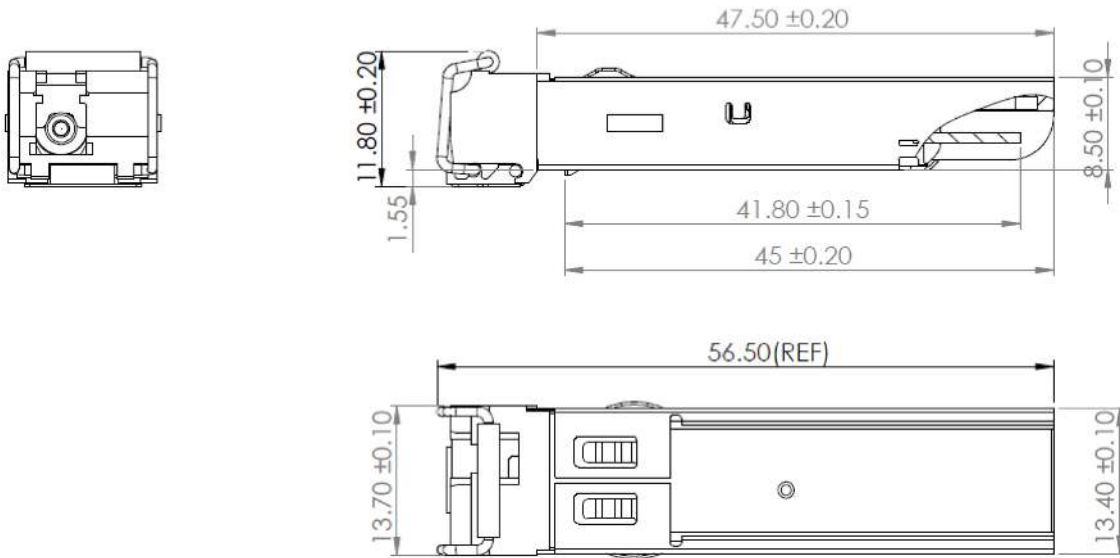

EEPROM Information

EEPROM memory map specific data field description is as below:

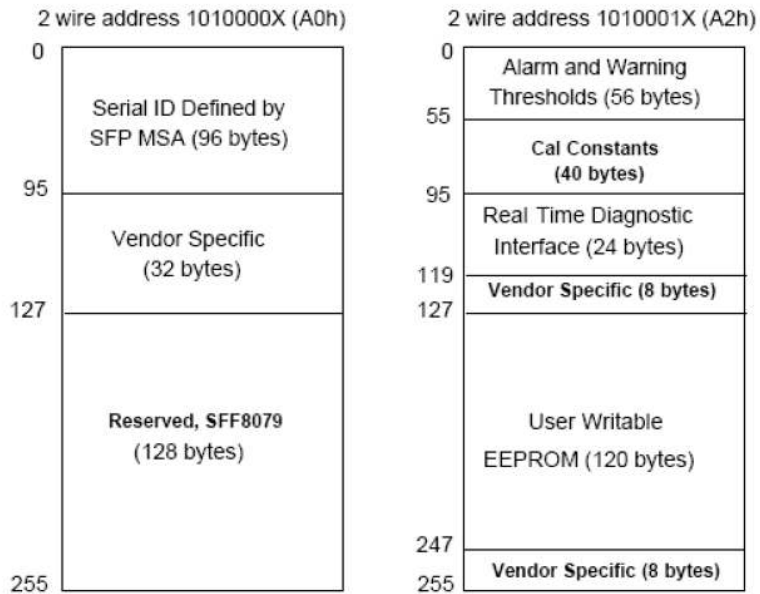

Digital Diagnostic Functions

This transceiver supports the 2-wire serial communication protocol as defined in SFP MSA. Digital diagnostic information is accessible over the 2-wire interface at the address 0xA2. Digital diagnostics are internally calibrated by default. The internal micro control unit accesses the device operating parameters in real time, such as transceiver temperature, laser bias current, transmitted optical power, received optical power and transceiver supply voltage. The module implements the alarm function of the SFP MSA, alerts the user when a particular operating parameter exceeds the factory-set normal range.

Parameter	Symbol	Accuracy	Report Range		Unit	Notes
Temperature	Temp	±3	-40	95	°C	
Voltage	VCC	±0.1	2.7	3.9	V	
Bias Current	Ibias	±10	1	80	mA	
Tx Power	P _{TX}	±3	-12	2	dBm	
Rx Power	P _{RX}	±3	-30	0	dBm	

About ProLabs

Our experience comes as standard; for over 15 years ProLabs has delivered optical connectivity solutions that give our customers freedom and choice through our ability to provide seamless interoperability. At the heart of our company is the ability to provide state-of-the-art optical transport and connectivity solutions that are compatible with over 90 optical switching and transport platforms.

Complete Portfolio of Network Solutions

ProLabs is focused on innovations in optical transport and connectivity. The combination of our knowledge of optics and networking equipment enables ProLabs to be your single source for optical transport and connectivity solutions from 100Mb to 400G while providing innovative solutions that increase network efficiency. We provide the optical connectivity expertise that is compatible with and enhances your switching and transport equipment.

Trusted Partner

Customer service is our number one value. ProLabs has invested in people, labs and manufacturing capacity to ensure that you get immediate answers to your questions and compatible product when needed. With Engineering and Manufacturing offices in the U.K. and U.S. augmented by field offices throughout the U.S., U.K. and Asia, ProLabs is able to be our customers best advocate 24 hours a day.



Contact Information

ProLabs US

Email: sales@prolabs.com

Telephone: 952-852-0252

ProLabs UK

Email: salessupport@prolabs.com

Telephone: +44 1285 719 600