



WIDEBAND

Low Noise Bypass Amplifier **ZX60-53LNB-S+**

Mini-Circuits

50Ω 0.5 to 5 GHz SMA Female

THE BIG DEAL

- Very wideband, 500 MHz – 5 GHz
- Ultra-flat gain, ± 0.6 dB from 700 to 2000 MHz
- Low NF over entire frequency band
- Internal bypass switching extends useable dynamic range
- Protected by US patent 6,790,049



Generic photo used for illustration purposes only

APPLICATIONS

- Wireless Base Station Systems
- Test and Measurement Systems
- Multi-Band Receivers

Model No.	ZX60-53LNB-S+
Case Style	GD958
Connectors	SMA Female

+RoHS Compliant

The +Suffix identifies RoHS Compliance. See our website for methodologies and qualifications

PRODUCT OVERVIEW

Mini-Circuits ZX60-53LNB-S+ is a low-noise amplifier offering industry-leading performance over its full frequency range from 500 MHz to 5 GHz. It contains internal switching, allowing the user control of the amplifier to handle both high and low signal levels by bypassing the LNA in the presence of large signals. The internal MMIC amplifier ZX60-53LNB-S+ utilizes E-PHEMT technology to achieve excellent noise figure performance in a unique cascade configuration enabling the combination of very wide band performance and flat gain. This model comes in a 48X30mm small connectorized package.

KEY FEATURES

Feature	Advantages
Ultra-wideband: 500 MHz – 5 GHz	Ideal for a wide range of receiver applications including military, commercial wireless, and instrumentation.
Very flat gain	Ideal for broadband or multi-band applications. Just one, cost-efficient model required for multiple frequency usage.
High IP3: 48 dBm typ. (bypass mode)	Provides enhanced linearity over broad frequency range under high signal conditions.
Internal bypass switch feature	Unique design handles low to high signal levels with minimal noise distortion.
Small size: 1.88" x 1.18"	This unique unibody size and construction enables the ZX60-53LNB-S+ to be used in compact connectorized applications.

REV. C
ECO-015740
ZX60-53LNB-S+
AG/CP/AM
221107



**WIDEBAND**

Low Noise Bypass Amplifier **ZX60-53LNB-S+**

Mini-Circuits®

50Ω 0.5 to 5 GHz SMA Female**ELECTRICAL SPECIFICATIONS AT 25°C, Zo=50Ω and +5V, UNLESS NOTED OTHERWISE**

Parameter	Condition (GHz)	Amplifier-ON			Amplifier-Bypass	Units
		Min.	Typ.	Max.	Typ.	
Frequency Range		0.5		5.0	0.5-5.0	GHz
Noise Figure	0.5		1.12		—	dB
	1.0		1.16		—	
	2.0		1.28		—	
	3.0		1.4		—	
	4.0		1.46		—	
	5.0		1.63		—	
Gain	0.5	—	22.0	—	-0.84	dB
	1.0	—	21.9	—	-0.96	
	2.0	19.5	21.2	23.9	-1.15	
	3.0	—	20.2	—	-1.4	
	4.0	—	19.0	—	-1.8	
	5.0	—	17.9	—	-1.8	
Gain Flatness	0.7-2.0		±0.6		±0.19	dB
Input VSWR	0.5	—	1.44	—	1.18	:1
	1.0	—	1.42	—	1.33	
	2.0	—	1.34	1.85	1.55	
	3.0	—	1.37	—	1.59	
	4.0	—	1.28	—	1.75	
	5.0	—	1.38	—	1.84	
Output VSWR	0.5	—	1.81	—	1.21	:1
	1.0	—	1.68	—	1.37	
	2.0	—	1.31	—	1.54	
	3.0	—	1.30	—	1.47	
	4.0	—	1.87	—	1.71	
	5.0	—	2.43	—	2.04	
Output Power @1dB compression AMP-ON ¹ Input Power @1dB compression AMP-Bypass ¹	0.5	—	20.8	—	32.0	dBm
	1.0	—	21.0	—	—	
	2.0	—	20.9	—	33.0	
	3.0	—	20.0	—	—	
	4.0	—	19.8	—	—	
	5.0	—	19.0	—	27.0	
Output IP3	0.5	—	35.3	—	45.4	dBm
	1.0	—	33.3	—	46.9	
	2.0	—	34.8	—	45.5	
	3.0	—	35.4	—	—	
	4.0	—	34.0	—	—	
	5.0	—	31.5	—	40.2	
Active Directivity (Isolation-Gain)	0.7-2.0	—	4.5		—	dB
Device Operating Voltage (Vdd)	—	4.8	5.0	5.2	4.8-5.2 (5.0 typ.)	V
Device Operating Current (Id)	—	—	95	105	2	mA
Enable Voltage (Ve)	—	—	5.0	—	0	V
Enable Control Current (Ie)	—	—	2.0	—	0	mA
DC Current (Id) Variation Vs. Temperature ²	—	—	-19	—	—	μA/°C
DC Current (Id) Variation Vs. Voltage	—	—	0.008	—	—	mA/mV

1. Current increases at P1dB.

2. (Current at 85°C - Current at -45°C)/130



WIDEBAND

Low Noise Bypass Amplifier **ZX60-53LNB-S+**

Mini-Circuits

50Ω 0.5 to 5 GHz SMA Female

ABSOLUTE MAXIMUM RATINGS³

Parameter		Ratings
Operating Temperature (ground lead)		-40°C to 85°C
Storage Temperature		-55°C to 100°C
Total Power Dissipation		0.7 W
Input Power	Amplifier-ON	+8 dBm (continuous), +19 dBm (5 min max.)
	Amplifier Bypass	+16 dBm (continuous), +29 dBm (5 min max.)
DC Voltage Vdd		+7.0V
DC Voltage Enable		+7.0V

3. Permanent damage may occur if any of these limits are exceeded. Electrical maximum ratings are not intended for continuous normal operation.

ENABLE VOLTAGE (Ve)

	Min	Typ.	Max.	Units
Amplifier-ON	4.5	5.0	5.5	V
Amplifier-Bypass	0	—	0.5	V

SWITCHING SPECIFICATIONS (RISE/FALL TIME)

Parameter		Min	Typ.	Max.	Units
Amplifier ON to Bypass	OFF TIME (50% Control to 10% RF)	—	50	—	ns
	FALL TIME (90 to 10% RF)	—	12	—	
Amplifier Bypass to ON	ON TIME (50% Control to 90% RF)	—	740	—	ns
	RISE TIME (10% to 90% RF)	—	240	—	
Control Voltage Leakage		—	65	—	mV

OUTLINE DRAWING

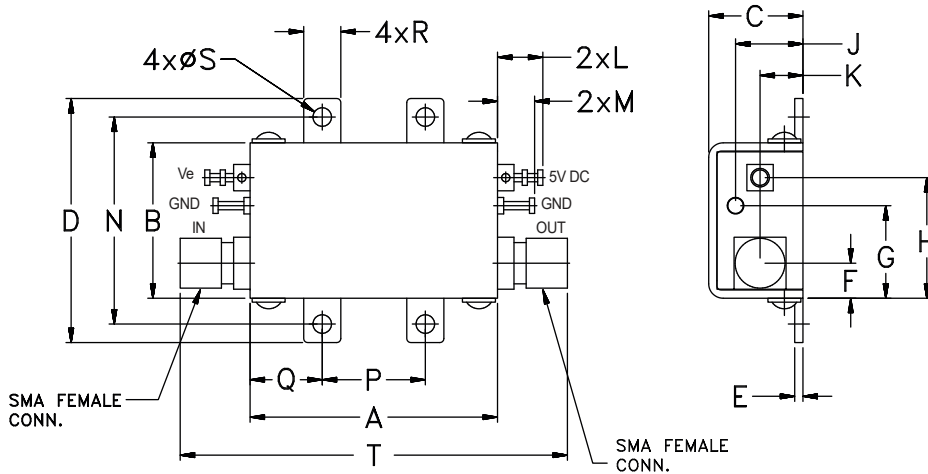

OUTLINE DIMENSIONS (Inches/mm)

A	B	C	D	E	F	G	H	J	K
1.20	.75	.46	1.18	.04	.17	.45	.58	.33	.21
30.48	19.05	11.68	29.97	1.02	4.32	11.43	14.73	8.38	5.33
L	M	N	P	Q	R	S	T	wt	
.22	.14	1.00	.50	.35	.18	.106	1.88	grams	
5.59	3.56	25.40	12.70	8.89	4.57	2.69	47.75	35.0	





WIDEBAND

Low Noise Bypass Amplifier ZX60-53LNB-S+

Mini-Circuits

50Ω 0.5 to 5 GHz SMA Female

TYPICAL PERFORMANCE DATA/CURVES

Frequency (MHz)	Gain (dB)	Directivity (dB)	VSWR (:1)		Power Out @1 dB COMPR. (dBm)	Noise Figure (dB)	IP3 (dBm)
			IN	OUT			
500	22.10	5.60	1.41	1.75	21.30	1.05	39.20
1000	22.00	5.00	1.39	1.62	21.60	1.11	36.60
1500	21.60	5.20	1.28	1.39	21.50	1.17	37.40
2000	21.30	5.50	1.28	1.21	21.60	1.28	36.00
2500	20.80	5.90	1.30	1.14	21.20	1.42	35.60
3000	20.40	6.30	1.24	1.21	20.80	1.32	35.80
3500	19.80	6.80	1.14	1.42	20.00	1.32	34.90
4000	19.20	7.40	1.12	1.71	20.20	1.36	34.40
4500	19.60	7.60	1.23	2.06	19.90	1.38	33.00
5000	18.10	8.50	1.23	2.02	19.90	1.53	32.60

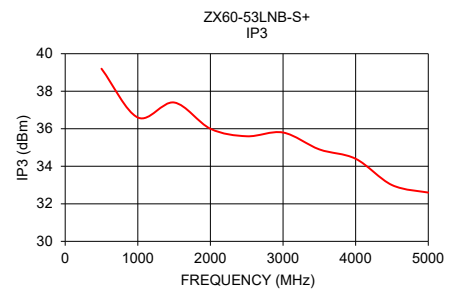
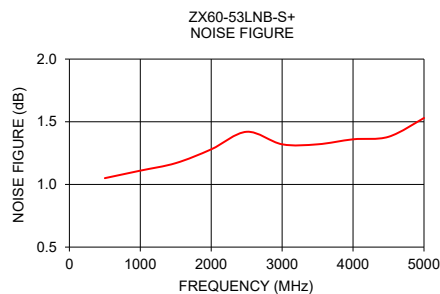
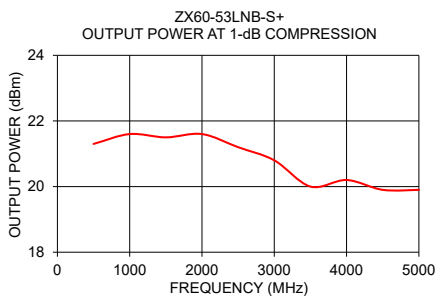
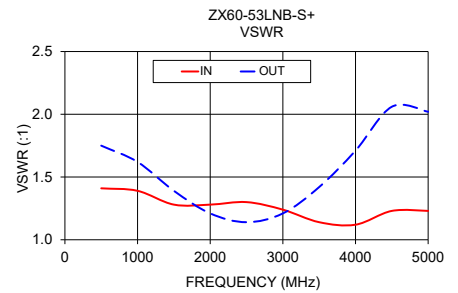
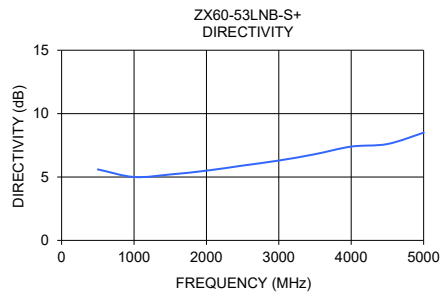
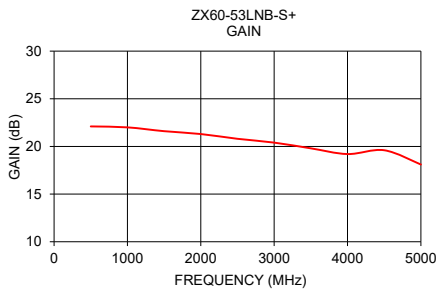

- NOTES**
- A. Performance and quality attributes and conditions not expressly stated in this specification document are intended to be excluded and do not form a part of this specification document.
 - B. Electrical specifications and performance data contained in this specification document are based on Mini-Circuit's applicable established test performance criteria and measurement instructions.
 - C. The parts covered by this specification document are subject to Mini-Circuits standard limited warranty and terms and conditions (collectively, "Standard Terms"); Purchasers of this part are entitled to the rights and benefits contained therein. For a full statement of the standard. Terms and the exclusive rights and remedies thereunder, please visit Mini-Circuits' website at www.minicircuits.com/terms/viewterm.html

