

AQ1205-01FTG

Bidirectional Discrete TVS Diode, General Purpose ESD Protection



Note: This package image is for example and reference only. For detail package drawing, please refer to the package section in this datasheet.

Pinout



Functional Block Diagram



Description

The AQ1205-01FTG bidirectional TVS is fabricated in a proprietary silicon avalanche technology. These diodes provide a high ESD (electrostatic discharge) protection level for electronic equipment. The AQ1205-01FTG TVS can safely absorb repetitive ESD strikes of ± 30 kV (contact and air discharge as defined in IEC 61000-4-2) without any performance degradation. In addition, it can safely dissipate a 7A 8/20 μ s surge event as defined in IEC 61000-4-5, 2nd Edition.

Features

- ESD, IEC 61000-4-2, ± 30 kV contact/air
- ESD, ISO10605 330pF 330 Ω , ± 30 kV contact/air
- EFT, IEC 61000-4-4, 40A (5/50ns)
- Maximum surge tolerance, IEC 61000-4-5, 2nd Edition, 7A (8/20 μ s)
- Low leakage current of 20nA (MAX) at 5V
- Low clamping voltage
- Halogen-free, lead-free and RoHS compliant
- Moisture Sensitivity Level (MSL -1)
- AEC-Q101 Qualified and PPAP Capable

Applications

- Automotive
- Battery
- Computer Peripherals
- Medical Equipment
- Notebooks / Desktops / Servers
- Point-of-Sale Terminals
- Switches / Buttons
- Test Equipment / Instrumentation

Life Support Note:

Not Intended for Use in Life Support or Life Saving Applications

The products shown herein are not designed for use in life sustaining or life saving applications unless otherwise expressly indicated.

AQ1205-01FTG

Bidirectional Discrete TVS Diode, General Purpose ESD Protection

Absolute Maximum Ratings

Symbol	Parameter	Value	Units
I_{PP}	Peak Current ($t_p=8/20\mu s$)	7	A
T_{OP}	Operating Temperature	-40 to 150	°C
T_{STOR}	Storage Temperature	-55 to 150	°C

CAUTION: Stresses above those listed in "Absolute Maximum Ratings" may cause permanent damage to the component. This is a stress only rating and operation of the component at these or any other conditions above those indicated in the operational sections of this specification is not implied.

Electrical Characteristics ($T_{OP}=25^\circ C$)

Parameter	Symbol	Test Conditions	Min	Typ	Max	Units
Reverse Standoff Voltage	V_{RWM}				5	V
Breakdown Voltage	V_{BR}	$I_R=1mA$	5.3	5.5		V
Reverse Leakage Current	I_{LEAK}	$V_R=5V$		1	20	nA
Clamp Voltage ¹	V_C	$I_{PP}=1A, t_p=8/20\mu s, I/O$ to GND		6.5		V
		$I_{PP}=7A, t_p=8/20\mu s, I/O$ to GND		10		V
Dynamic Resistance ²	R_{DYN}	TLP, $t_p=100ns, I/O$ to GND		0.2		Ω
ESD Withstand Voltage ^{1,3}	V_{ESD}	IEC 61000-4-2 (Contact Discharge)	± 30			kV
		IEC 61000-4-2 (Air Discharge)	± 30			kV
		ISO10605 (Contact Discharge)	± 30			kV
		ISO10605 (Air Discharge)	± 30			kV
Diode Capacitance ¹	C_{IO-GND}	Reverse Bias=5V, $f=1MHz, I/O$ to GND		7	9	pF

Note:

- Parameter is guaranteed by design and/or component characterization.
- Transmission Line Pulse (TLP) with 100ns width, 0.2ns rise time, and average window $t_1=70ns$ to $t_2=90ns$
- Device stressed with ten non-repetitive ESD pulses.

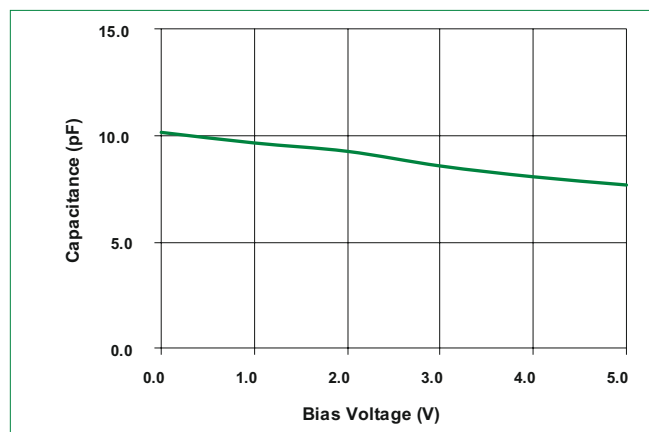
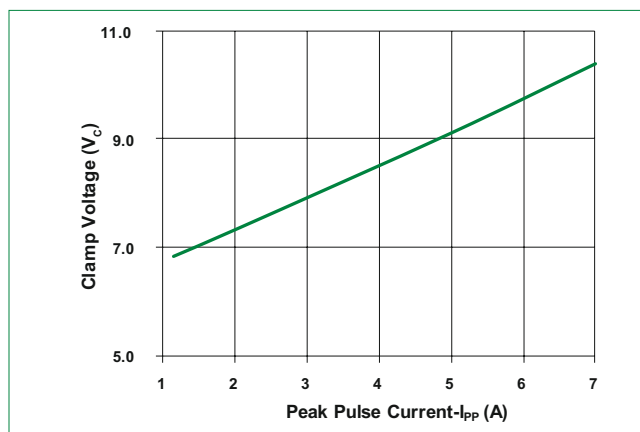
Capacitance vs. Reverse Bias**Clamping Voltage vs I_{PP}** 

AQ1205-01FTG

Bidirectional Discrete TVS Diode, General Purpose ESD Protection

Positive Transmission Line Pulsing (TLP) Plot

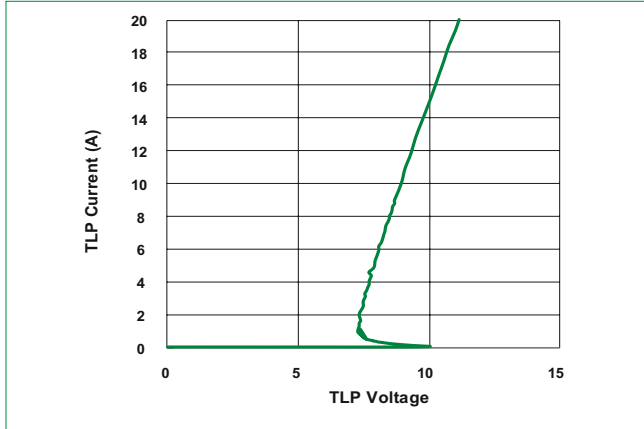

Negative Transmission Line Pulsing (TLP) Plot

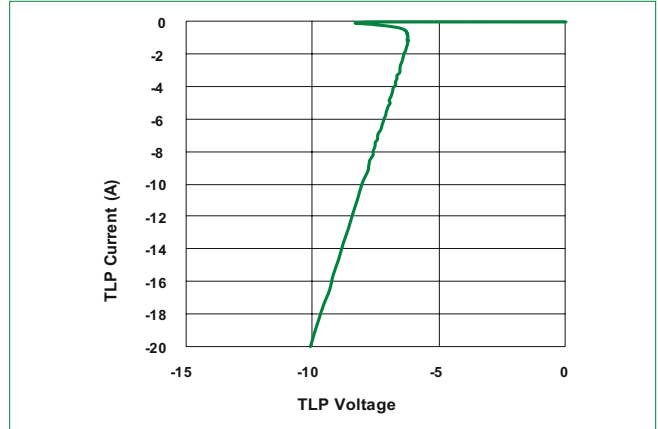

IEC 61000-4-2 +8 kV Contact ESD Clamping Voltage



IEC 61000-4-2 -8 kV Contact ESD Clamping Voltage

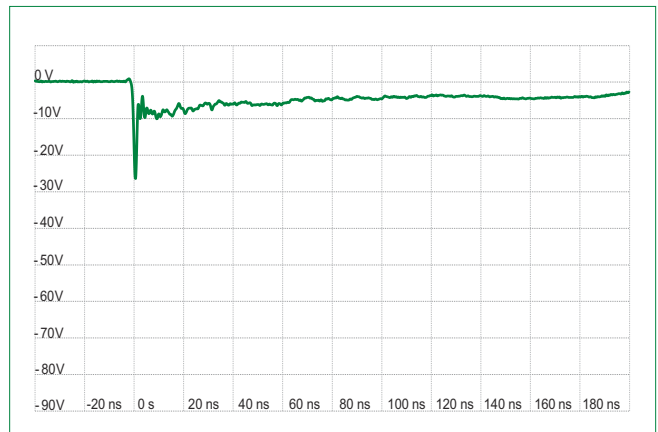

ISO10605 Contact Discharge Plot at +8 kV



ISO10605 Contact Discharge Plot at -8 kV

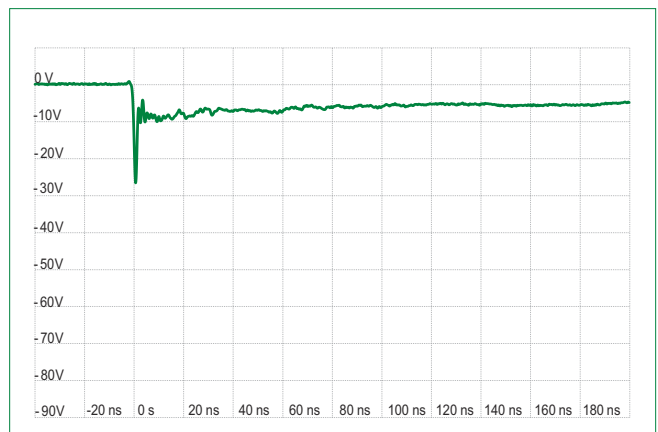

AQ1205-01FTG

Bidirectional Discrete TVS Diode, General Purpose ESD Protection

8/20µs Pulse Waveform

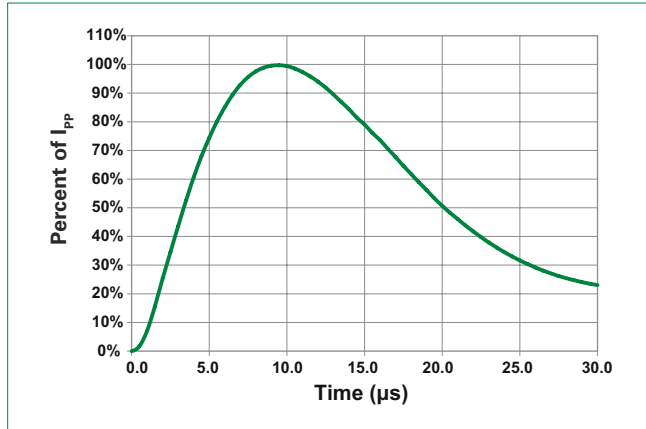

Soldering Parameters

Reflow Condition		Pb – Free assembly
Pre Heat	- Temperature Min ($T_{s(min)}$)	150°C
	- Temperature Max ($T_{s(max)}$)	200°C
	- Time (min to max) (t_s)	60 – 120 secs
Average ramp up rate (Liquidus) Temp (T_L) to peak		3°C/second max
$T_{S(max)}$ to T_L - Ramp-up Rate		3°C/second max
Reflow	- Temperature (T_L) (Liquidus)	217°C
	- Temperature (t_L)	60 – 150 seconds
Peak Temperature (T_p)		260 ^{+0/-5} °C
Time within 5°C of actual peak Temperature (t_p)		30 seconds
Ramp-down Rate		6°C/second max
Time 25°C to peak Temperature (T_p)		8 minutes Max.
Do not exceed		260°C

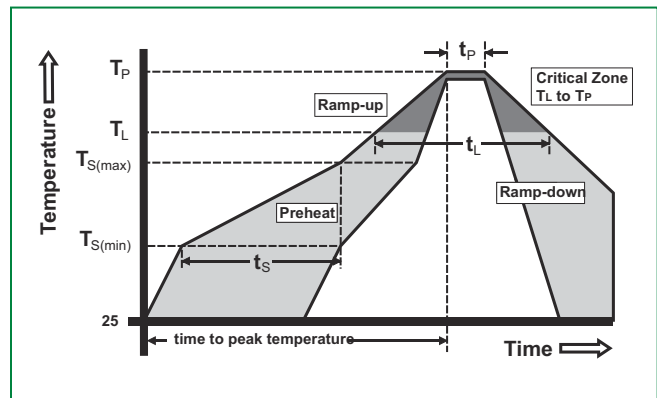

Ordering Information

Part Number	Package	Min. Order Qty.
AQ1205-01FTG	SOD323	3,000

Product Characteristics

Lead Plating	Matte Tin
Lead material	Copper Alloy
Substrate Material	Silicon
Body Material	Molded Compound
Flammability	UL Recognized compound meeting flammability rating V-0

Part Marking System

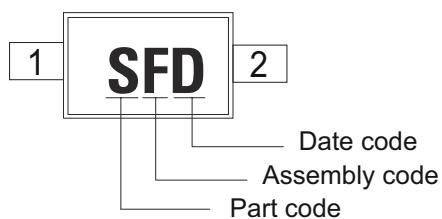

Part Numbering System

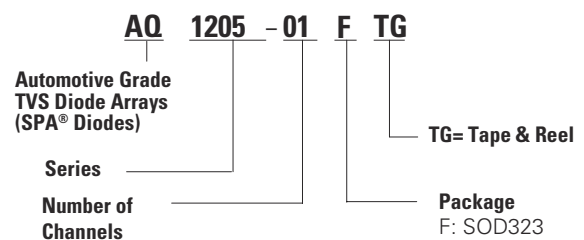

AQ1205-01FTG

Bidirectional Discrete TVS Diode, General Purpose ESD Protection

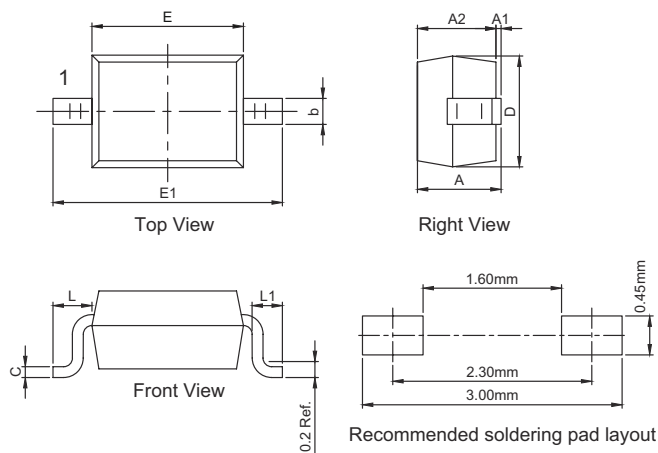
Package Dimensions — SOD323

Symbol	Millimeters		Inches	
	Min	Max	Min	Max
A	-	1.00	-	0.039
A1	0.00	0.10	0.000	0.004
A2	0.80	0.90	0.031	0.035
b	0.25	0.35	0.010	0.014
c	0.08	0.15	0.003	0.006
D	1.20	1.40	0.047	0.055
E	1.60	1.80	0.063	0.071
E1	2.50	2.75	0.098	0.108
L1	0.25	0.40	0.010	0.016
L	0.475 REF		0.019 REF	

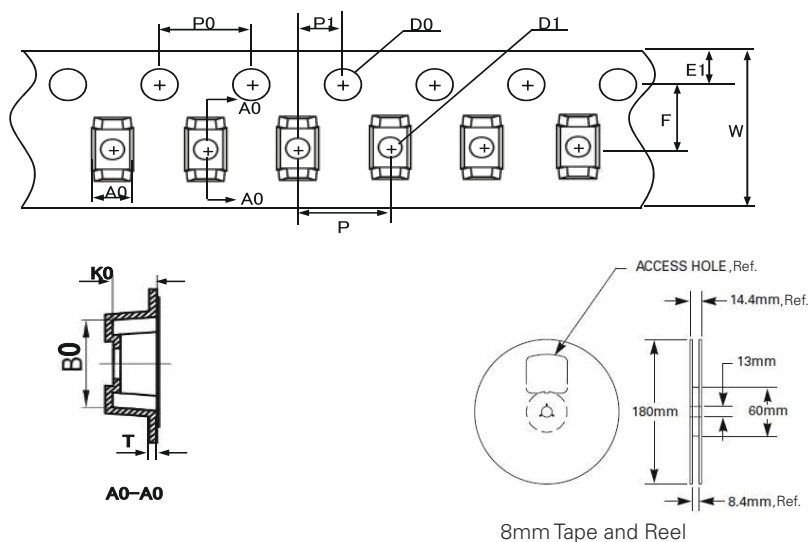
Embossed Carrier Tape & Reel Specification — SOD323

Symbol	Millimeters
A0	1.36min/1.62max
B0	2.90+/-0.10
W	8.0+0.3/-0.10
D0	1.50+0.10
D1	ø1.00min/ø1.25max
E	1.75+/-0.10
F	3.50+/-0.05
P0	4.00+/-0.10
P	4.00+/-0.10
P1	2.00+/-0.05
K0	1.15min/1.45max
T	0.254+/-0.13

8mm Tape and Reel

Product Disclaimer: Littelfuse products are not designed for, and shall not be used for, any purpose (including, without limitation, automotive, military, aerospace, medical, life-saving, life-sustaining or nuclear facility applications, devices intended for surgical implant into the body, or any other application in which the failure or lack of desired operation of the product may result in personal injury, death, or property damage) other than those expressly set forth in applicable Littelfuse product documentation. Warranties granted by Littelfuse shall be deemed void for products used for any purpose not expressly set forth in applicable Littelfuse documentation. Littelfuse shall not be liable for any claims or damages arising out of products used in applications not expressly intended by Littelfuse as set forth in applicable Littelfuse documentation. The sale and use of Littelfuse products is subject to Littelfuse Terms and Conditions of Sale, unless otherwise agreed by Littelfuse. "Littelfuse" includes Littelfuse, Inc., and all of its affiliate entities. <http://www.littelfuse.com/disclaimer-electronics>.