



circuit breaker 3VA5 UL frame 250 breaking capacity class H 65kA @ 480 V 3-pole, line protection TM230, FTAM, In=110A overload protection Ir=110A fixed short-circuit protection li=5...10 x In nut keeper kit on both sides

Model	
product brand name	SENTRON
product designation	Molded-case circuit breaker
product designation / according to UL file	HFAS
Product version	System protection
design of the load switch / according to UL 489 / Heating, Air Conditioning, and Refrigeration circuit breaker (HACR Type)	Yes
design of the load switch / according to UL 489 / High-Intensity-Discharge circuit breaker (HID Type)	No
design of the load switch / according to UL 489 / Switching Duty circuit breaker (SWD Type)	No
design of the overcurrent release	TM230
protection function of the overcurrent release	LI
number of poles	3
General technical data	
rated insulation voltage Ui	800 V
Max. rated operational voltage Ue with DC	750 V
operating voltage / at AC / rated value	690 V
power loss [W] / maximum	23 W
Active power loss / for rated value of the current / at AC / in hot operating state / per pole	7.53 W
mechanical service life (switching cycles) / typical	20 000
Electrical endurance (switching cycles) / at AC-1 / at 380/415 V 50/60 Hz	8 000
Electrical endurance (switching cycles) / at AC-1 / at 690 V 50/60 Hz	4 000
electrical endurance (switching cycles) / at 480 V	8 000
electrical endurance (switching cycles) / at 600 V	4 000
Neutral conductors / upgradeable/retrofitable	No
ground-fault monitoring version	without
product function	
• communication function	No
• other measurement function	No
Net Weight	2.192 kg
Current	
marking / according to UL 489 / 100%-rated breaker	No
operational current	
• at 40 °C	110 A
• at 45 °C	107 A
• at 50 °C	104 A

<ul style="list-style-type: none"> • at 55 °C • at 60 °C • at 65 °C • at 70 °C 	100 A 97 A 94 A 91 A
Switching capacity according to IEC 60947	
switching capacity class of the circuit breaker	H
breaking capacity maximum short-circuit current (Icu) <ul style="list-style-type: none"> • at 240 V • at 415 V • at 690 V 	100 kA 70 kA 10 kA
breaking capacity operating short-circuit current (Ics) <ul style="list-style-type: none"> • at 240 V • at 415 V • at 690 V 	100 kA 70 kA 10 kA
short-circuit current making capacity (Icm) <ul style="list-style-type: none"> • at 240 V • at 415 V • at 690 V 	220 kA 154 kA 17 kA
design of short-circuit protection	For switching power values in DC networks, see the 3VA molded case circuit breaker device manual; link to be found under Service & Support in the last chapter
Switching capacity according to UL 489	
breaking capacity current <ul style="list-style-type: none"> • at 240 V • at 480 V • at 600 V 	100 kA 65 kA 25 kA
Adjustable parameters	
Adjustable response value current / I _g min.	110 A
Adjustable response value current / I _g min.	110 A
Ground fault protection / tripping switchable / I _{2t} =ON/OFF	No
Mechanical Design	
height [in]	7.28 in
Height	185 mm
width [in]	4.13 in
Width	105 mm
depth [in]	3.27 in
depth	83 mm
Connections	
arrangement of electrical connectors / for main current circuit	Front connection
type of electrical connection / for main current circuit	nut keeper kit on both ends
Type of connectable conductor cross-section, connection screw, width x thickness , min.	13 x 1 mm
Type of connectable conductor cross-section, connection screw, width x thickness , max.	25 x 8 mm
design of the surface / of the connections / on the bottom of the switch (N, 2, 4, 6)	silver
Auxiliary circuit	
product component <ul style="list-style-type: none"> • undervoltage release • voltage trigger • trip indicator 	No No No
number of CO contacts / for auxiliary contacts	0
Accessories	
product extension / optional / motor drive	Yes
Environmental conditions	
protection class IP / on the front	IP40
ambient temperature <ul style="list-style-type: none"> • during operation / minimum • during operation / maximum 	-25 °C 70 °C

- during storage / minimum
- during storage / maximum

-40 °C
80 °C

Certificates

reference code / according to IEC 81346-2

Q

General Product Approval

EMC

Declaration of
Conformity



[Confirmation](#)



Declaration of
Conformity

Marine / Shipping

other



EG-Konf.



ABS

[Miscellaneous](#)

Further information

Information- and Downloadcenter (Catalogs, Brochures,...)

<http://www.siemens.com/lowvoltage/catalogs>

Industry Mall (Online ordering system)

<https://mall.industry.siemens.com/mall/en/en/Catalog/product?mlfb=3VA5211-6EC32-0AA0>

Service&Support (Manuals, Certificates, Characteristics, FAQs,...)

<https://support.industry.siemens.com/cs/ww/en/ps/3VA5211-6EC32-0AA0>

Image database (product images, 2D dimension drawings, 3D models, device circuit diagrams, ...)

http://www.automation.siemens.com/bilddb/cax_en.aspx?mlfb=3VA5211-6EC32-0AA0

CAX-Online-Generator

<http://www.siemens.com/cax>

Tender specifications

<http://www.siemens.com/specifications>

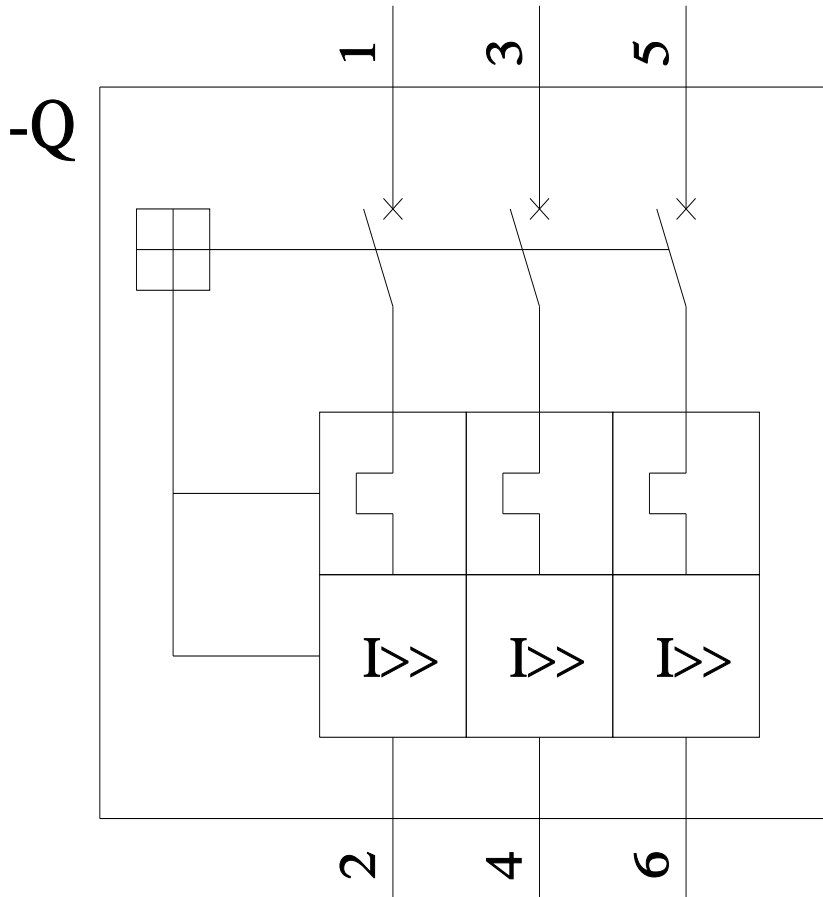
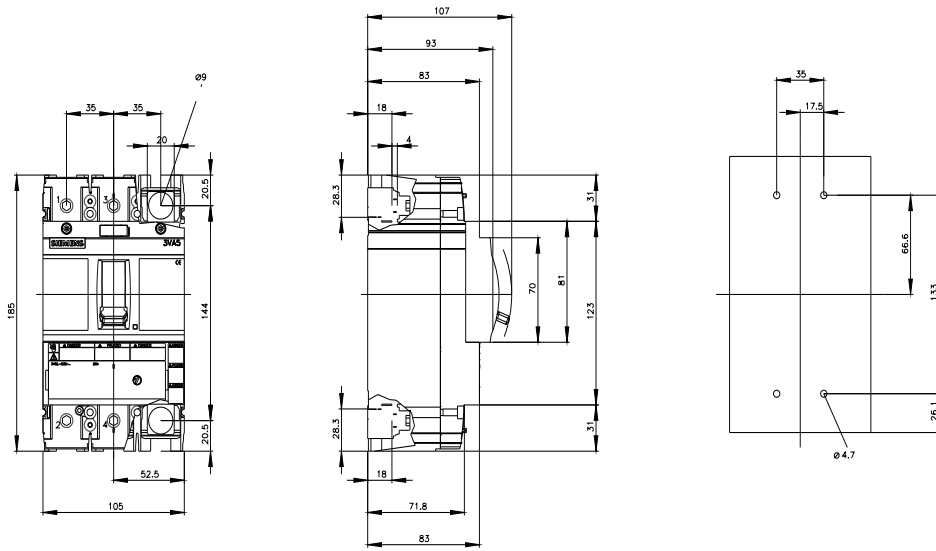

CB



last modified:

7/15/2022 

