

**SERIES:** CP85H | **DESCRIPTION:** PELTIER MODULE**FEATURES**

- arcTEC™ structure on select models
- enhanced reliability for high thermal cycling
- superior thermal performance
- silicon sealed
- wide  $\Delta T$  max
- low profile
- precise temperature control
- solid state construction

**MODEL**

	input voltage <sup>1</sup>	input current <sup>2</sup>	internal resistance <sup>3</sup>	output Qmax <sup>4</sup>		output $\Delta T$ max <sup>5</sup>	
	max [Vdc]	max [A]	typ [ $\Omega \pm 10\%$ ]	$T_h = 27^\circ\text{C}$ [W]	$T_h = 50^\circ\text{C}$ [W]	$T_h = 27^\circ\text{C}$ [°C]	$T_h = 50^\circ\text{C}$ [°C]
CP85134H	2.1	8.5	0.2	10.3	11.3	70	77
CP85153034H	4.2	8.5	0.4 <sup>7</sup>	21	23	70	77
CP85234H	3.8	8.5	0.35	18.8	20.8	70	77
CP852040345H <sup>6</sup>	7.6	8.5	0.75	38.2	42	70	77
CP85301534H	4.2	8.5	0.4 <sup>7</sup>	21	23	70	77
CP853345H <sup>6</sup>	8.8	8.5	0.85	43.1	48	70	77
CP8530345 <sup>6</sup>	11.8	8.5	1.15	57.7	63.4	70	77
CP854020345H <sup>6</sup>	7.6	8.5	0.75	38.2	42	70	77
CP854345H <sup>6</sup>	15.7	8.5	1.5	77.1	85	70	77

- Notes:
1. Maximum voltage at  $\Delta T$  max and  $T_h = 27^\circ\text{C}$
  2. Maximum current to achieve  $\Delta T$  max
  3. Measured by AC 4-terminal method at  $25^\circ\text{C}$
  4. Maximum heat absorbed at cold side occurs at  $I_{\text{max}}$ ,  $V_{\text{max}}$ , and  $\Delta T = 0^\circ\text{C}$
  5. Maximum temperature difference occurs at  $I_{\text{max}}$ ,  $V_{\text{max}}$ , and  $Q = 0\text{W}$  ( $\Delta T$  max measured in a vacuum at 1.3 Pa)
  6. Designed with arcTEC™ structure.
  7. Internal resistance tolerance is  $\pm 12.5\%$

## SPECIFICATIONS

parameter	conditions/description	min	typ	max	units
solder melting temperature	connection between thermoelectric pairs	235			°C
assembly compression				1	MPa
RoHS	yes				

## MECHANICAL DRAWING

units: mm

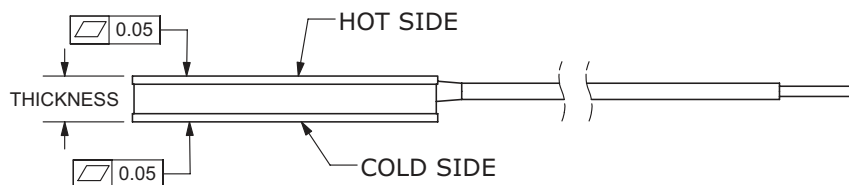

	MATERIAL	PLATING
ceramic plate	96% AL <sub>2</sub> O <sub>3</sub>	
wire leads	20 AWG	tin
sealer	silicon rubber 703 RTV (between cold and hot side plates)	
joint cover	silicon rubber 703 RTV	
marking	P/N & S/N printed on cold side surface	

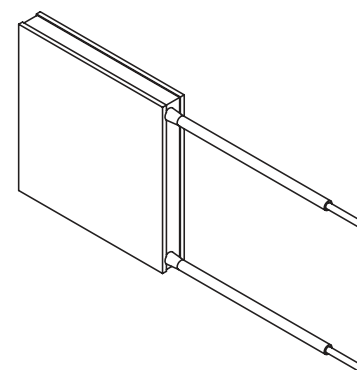
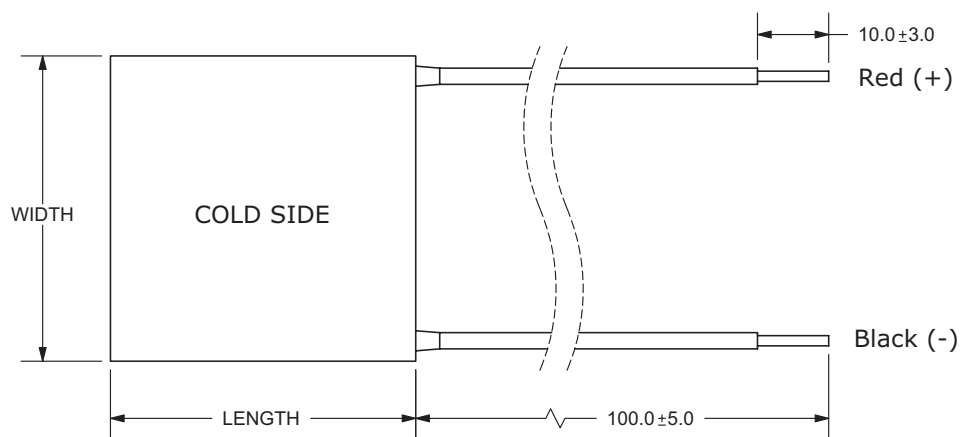

MODEL NO.	LENGTH [mm]	WIDTH [mm]	THICKNESS [mm]
CP85134H	15 ±0.3	15 ±0.3	3.4 ±0.025
CP85153034H	15 ±0.3	30 ±0.3	3.4 ±0.025
CP85234H	20 ±0.3	20 ±0.3	3.4 ±0.025
CP852040345H	20 ±0.3	40 ±0.3	3.45 ±0.025
CP85301534H	30 ±0.3	15 ±0.3	3.4 ±0.025
CP853345H	30 ±0.3	30 ±0.3	3.45 ±0.025
CP8530345	30 ±0.3	30 ±0.3	3.45 ±0.025
CP854020345H	40 ±0.3	20 ±0.3	3.45 ±0.025
CP854345H	40 ±0.3	40 ±0.3	3.45 ±0.025

## CP85134H PERFORMANCE (Th=27°C)

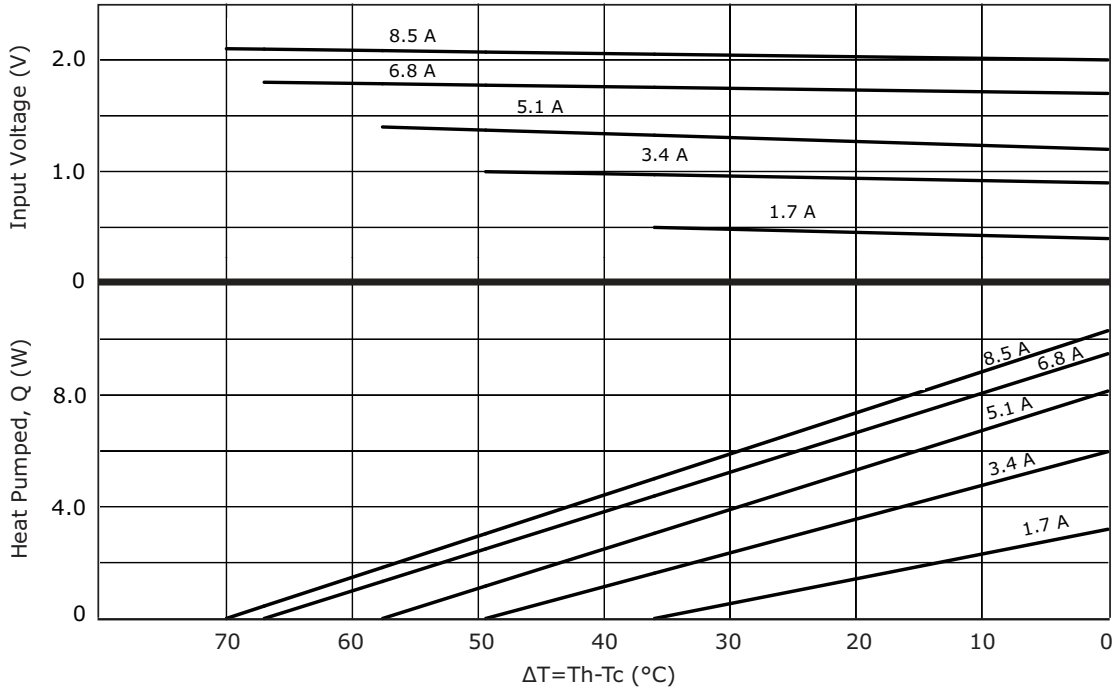

## CP85134H PERFORMANCE (Th=50°C)

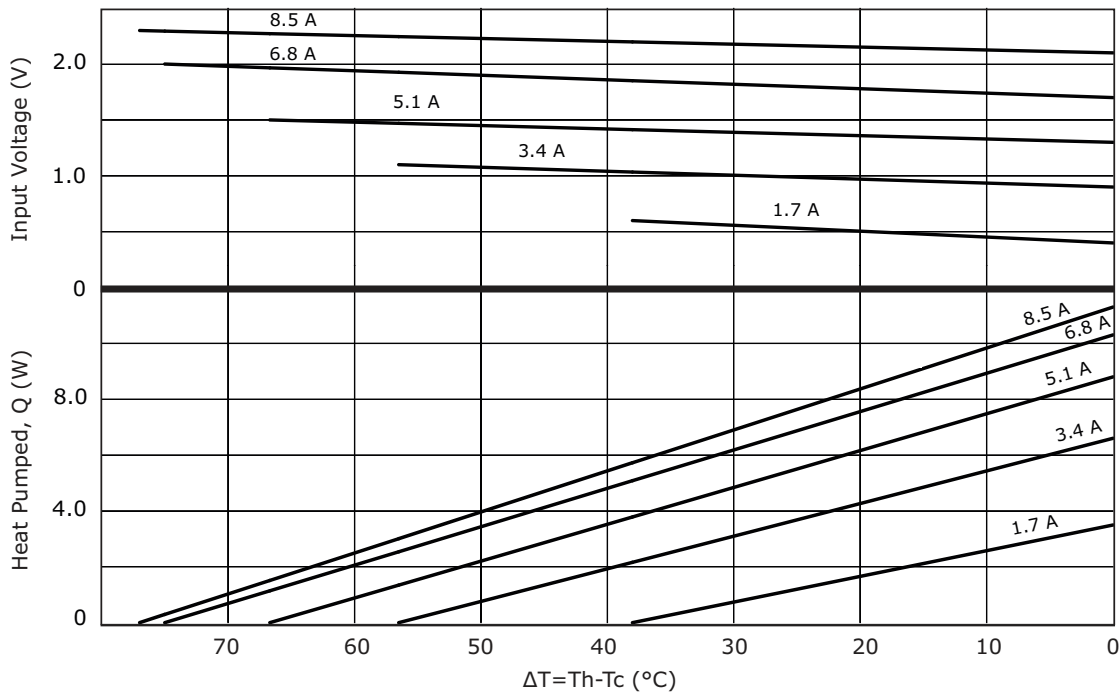

## CP85153034H PERFORMANCE (Th=27°C)

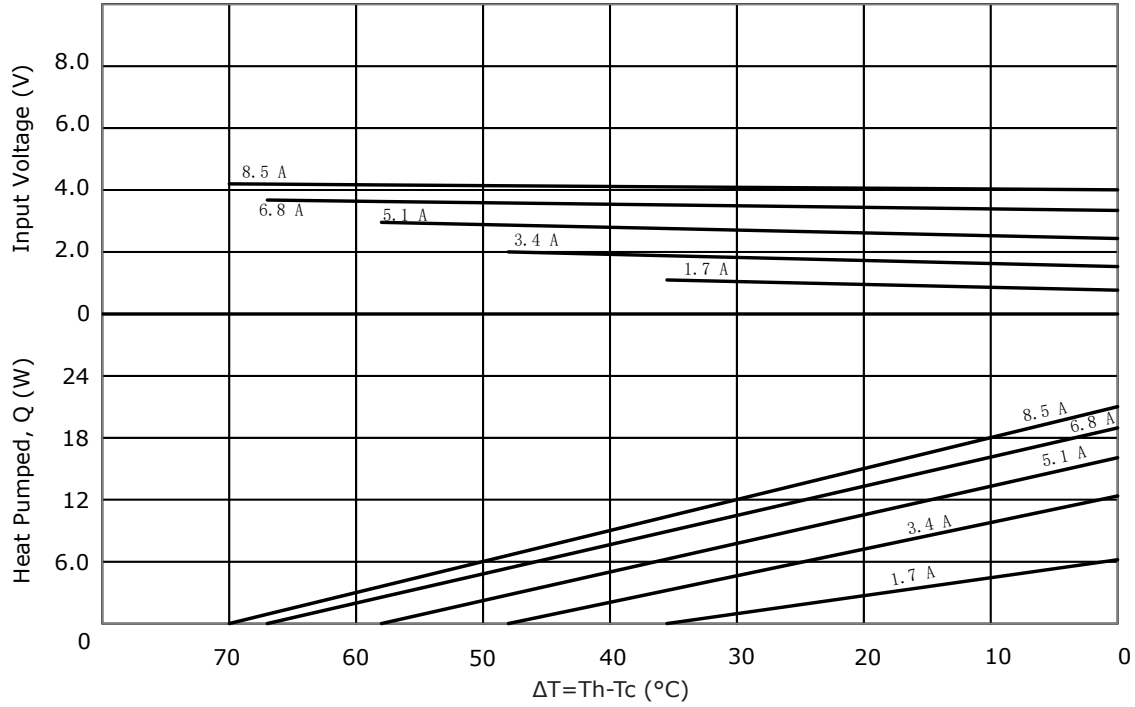

## CP85153034H PERFORMANCE (Th=50°C)

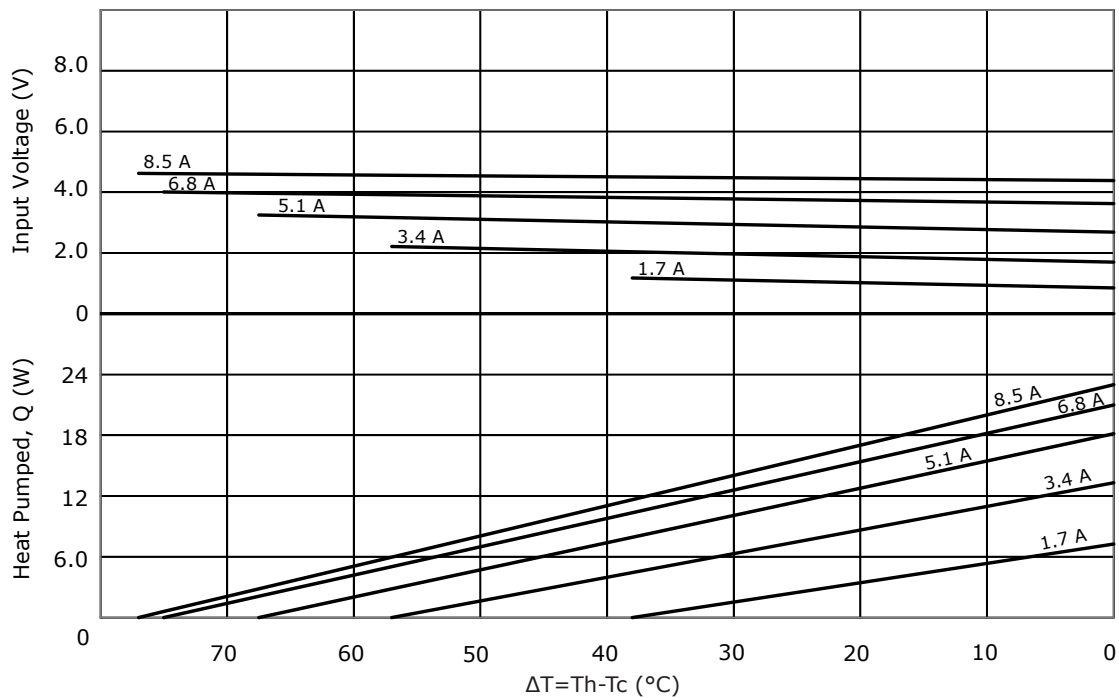

## CP85234H PERFORMANCE (Th=27°C)

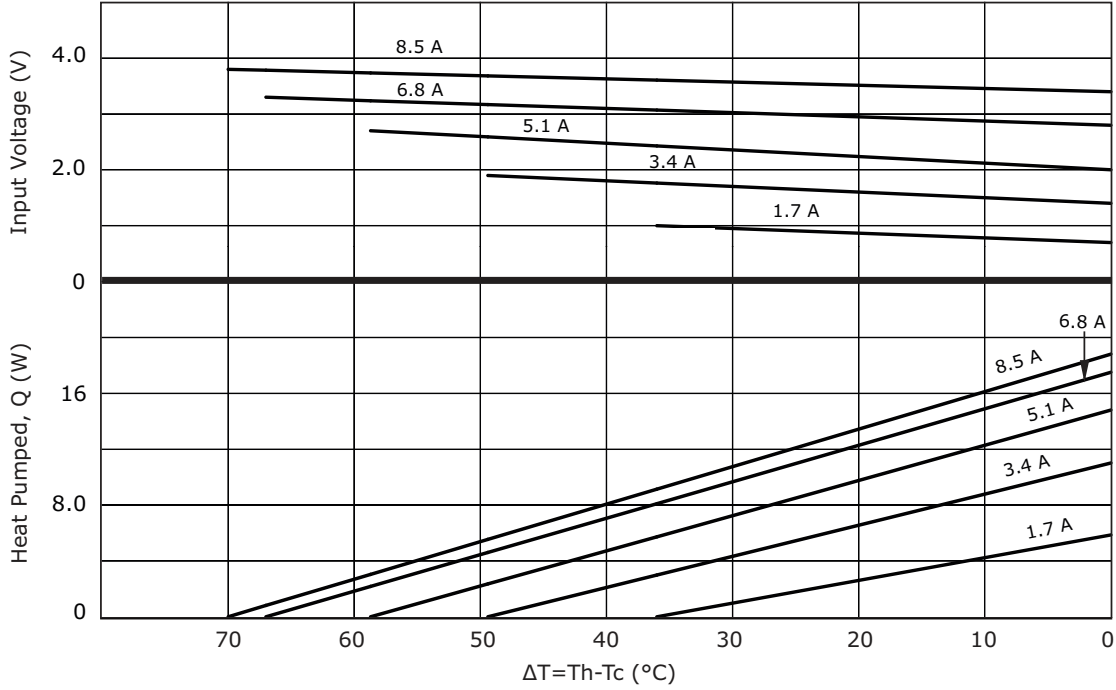

## CP85234H PERFORMANCE (Th=50°C)

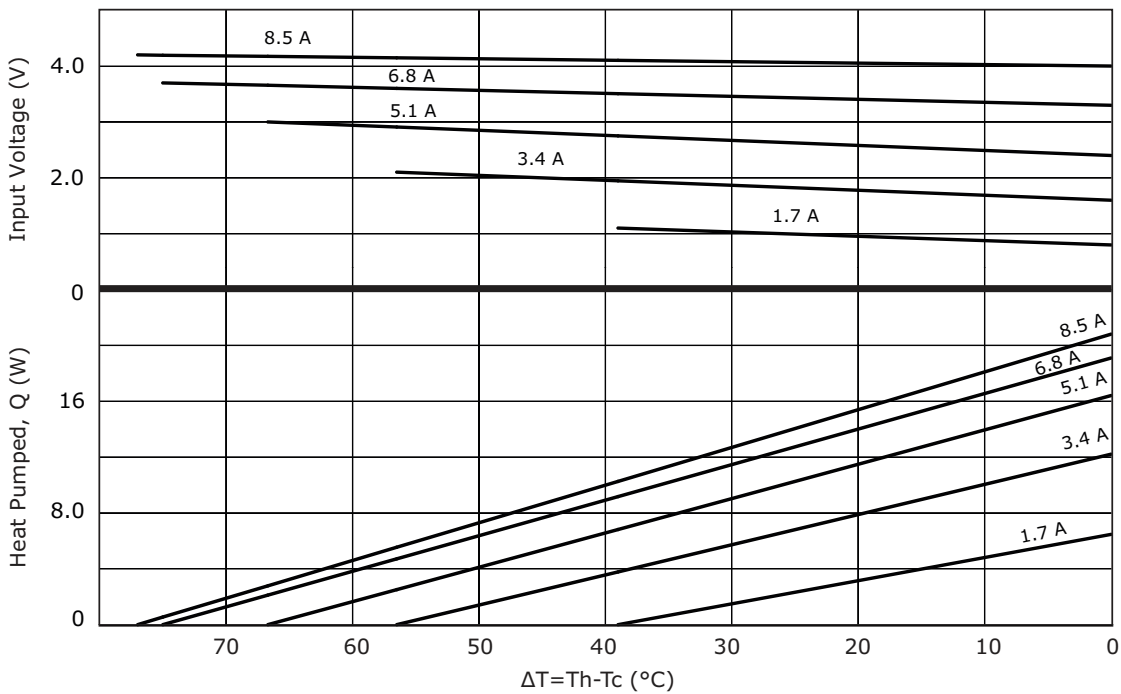

## CP852040345H PERFORMANCE (Th=27°C)

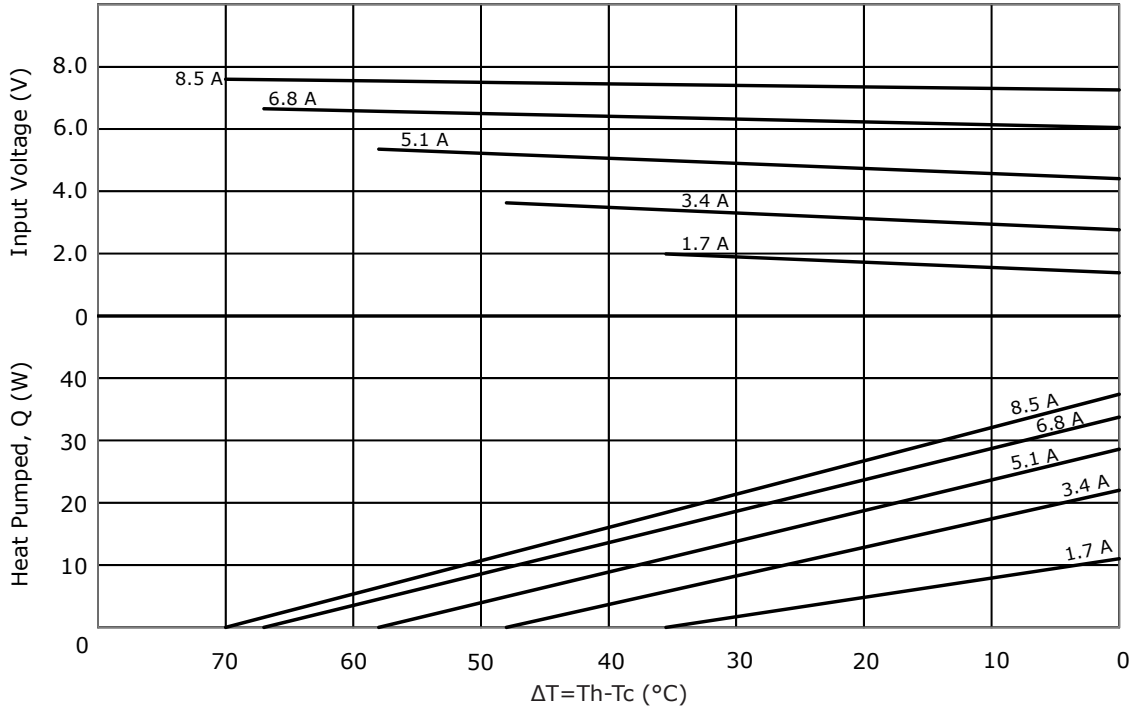

## CP852040345H PERFORMANCE (Th=50°C)

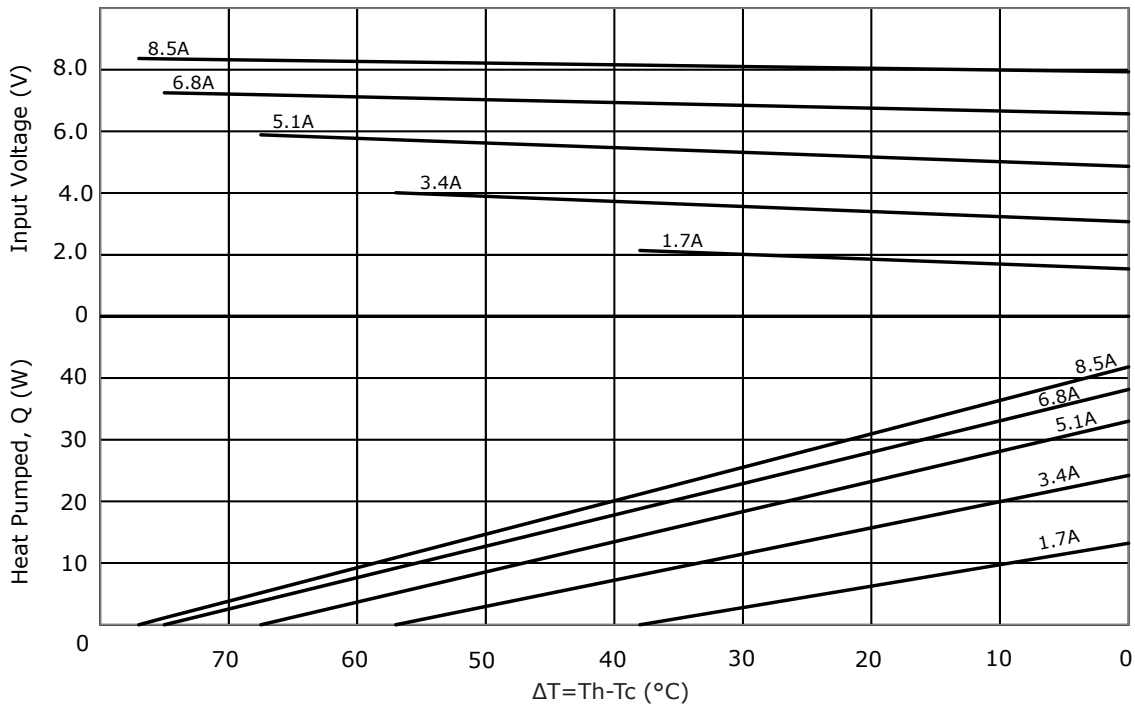

### CP85301534H PERFORMANCE (Th=27°C)

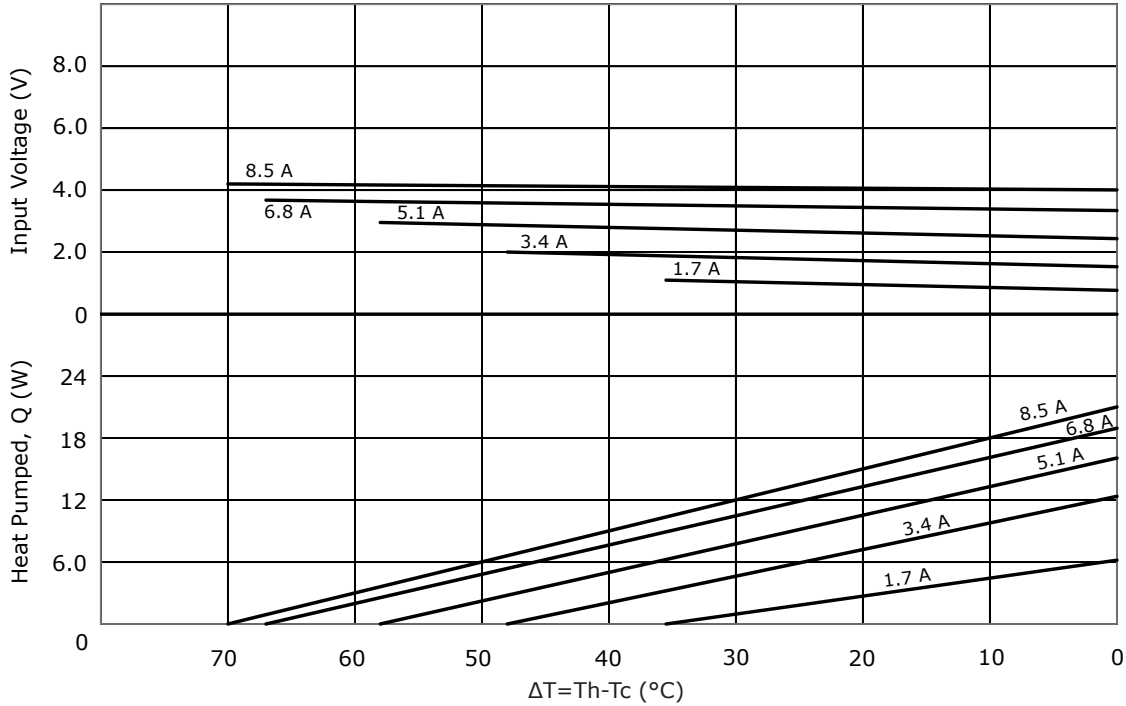

### CP85301534H PERFORMANCE (Th=50°C)

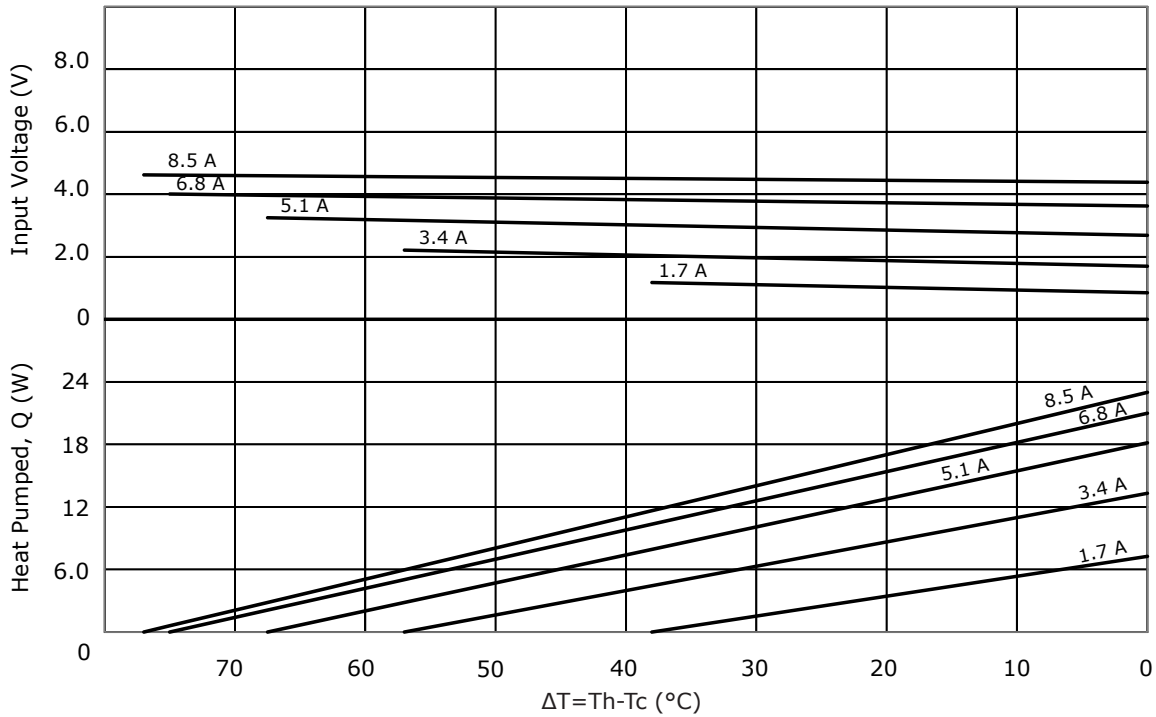

## CP853345H PERFORMANCE (Th=27°C)

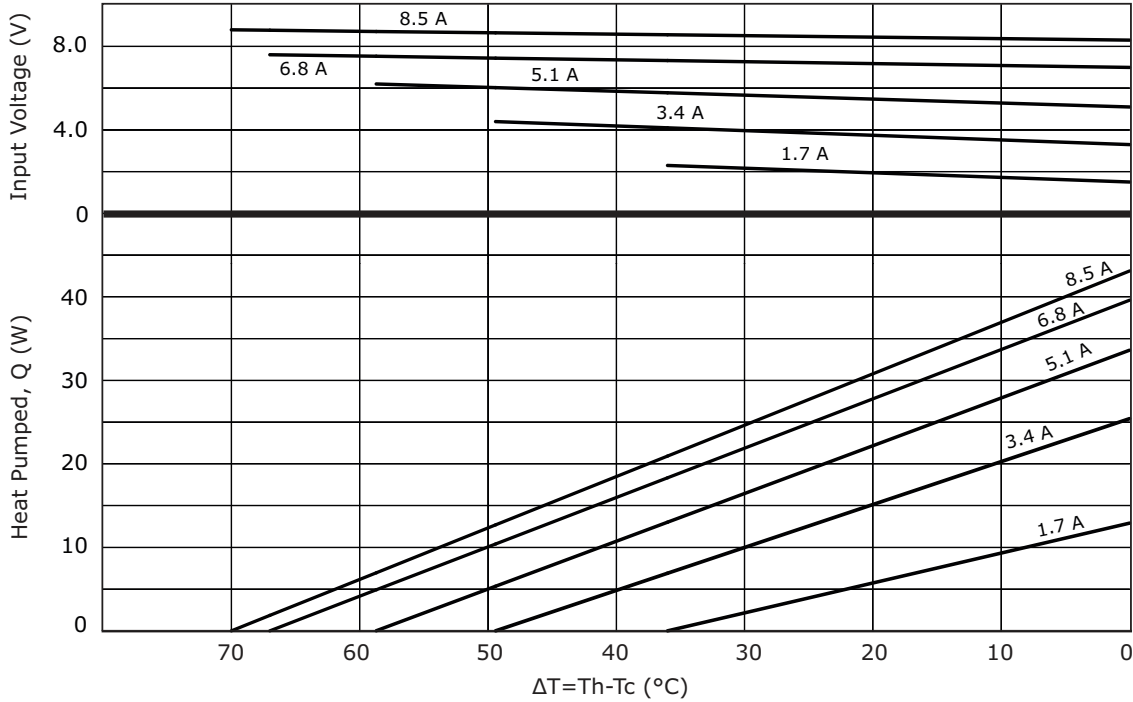

## CP853345H PERFORMANCE (Th=50°C)

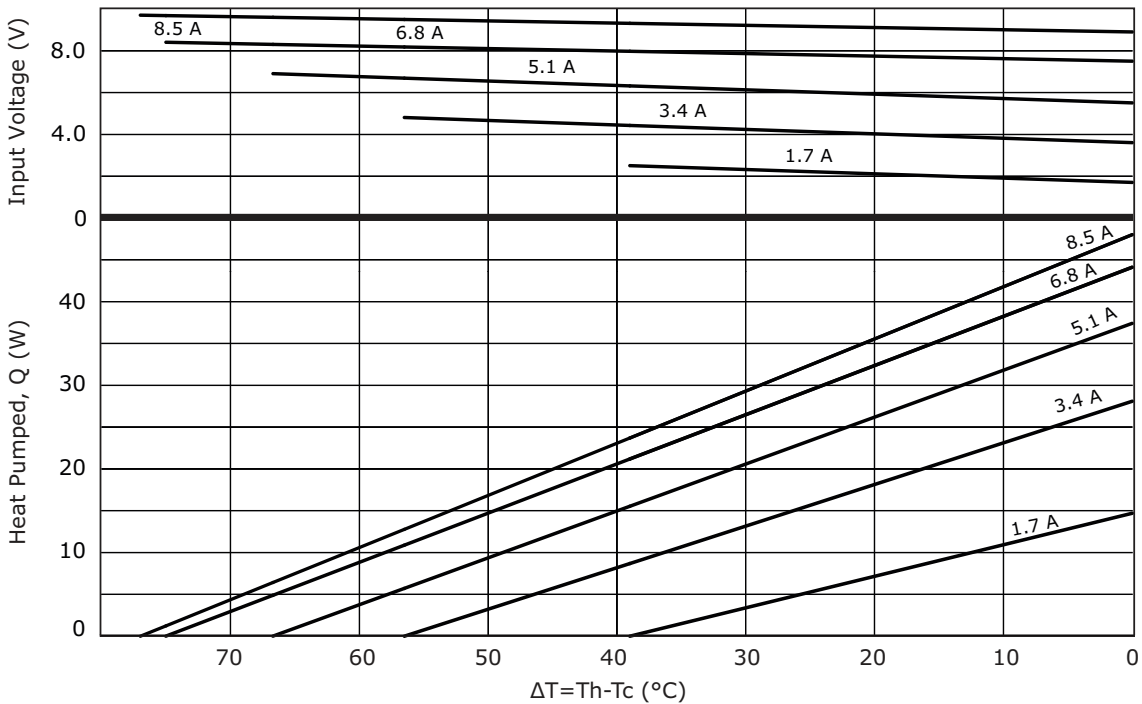



## CP8530345 PERFORMANCE (Th=27°C)

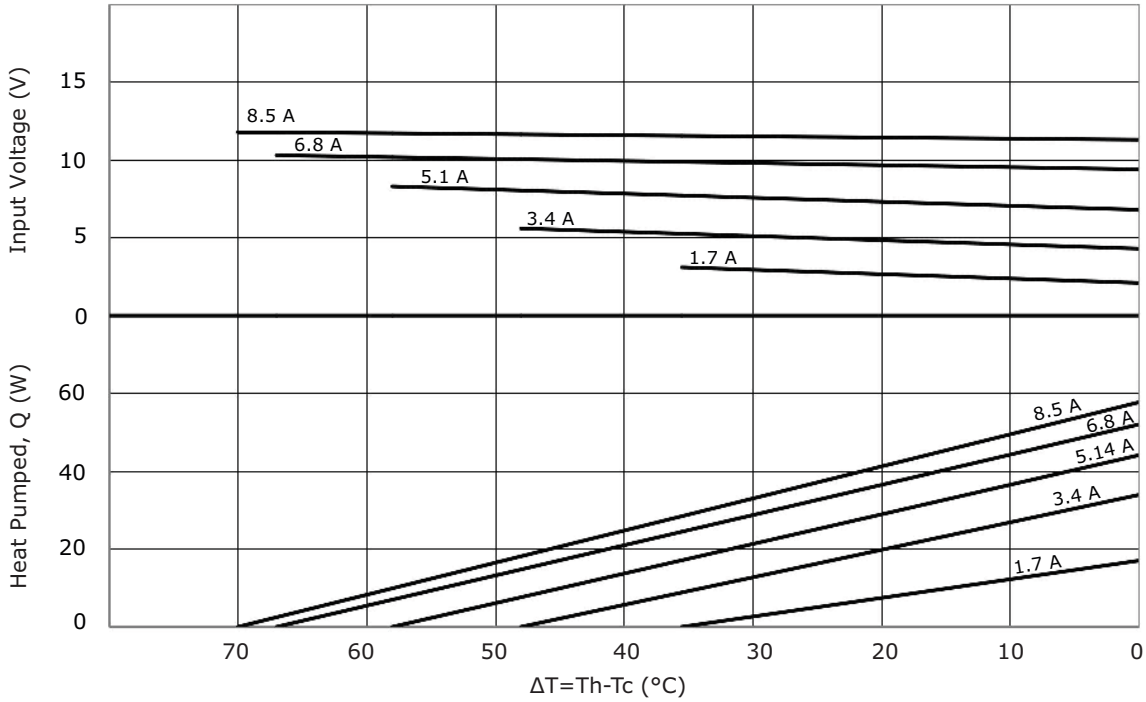

## CP8530345 PERFORMANCE (Th=50°C)

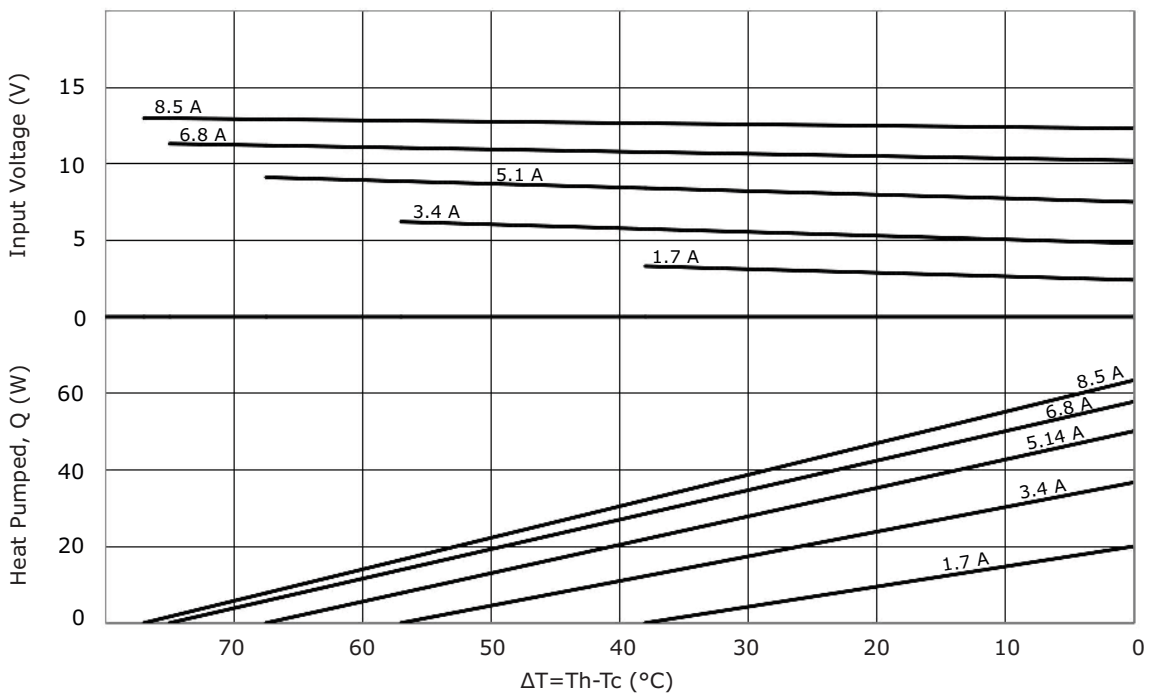

## CP854020345H PERFORMANCE (Th=27°C)

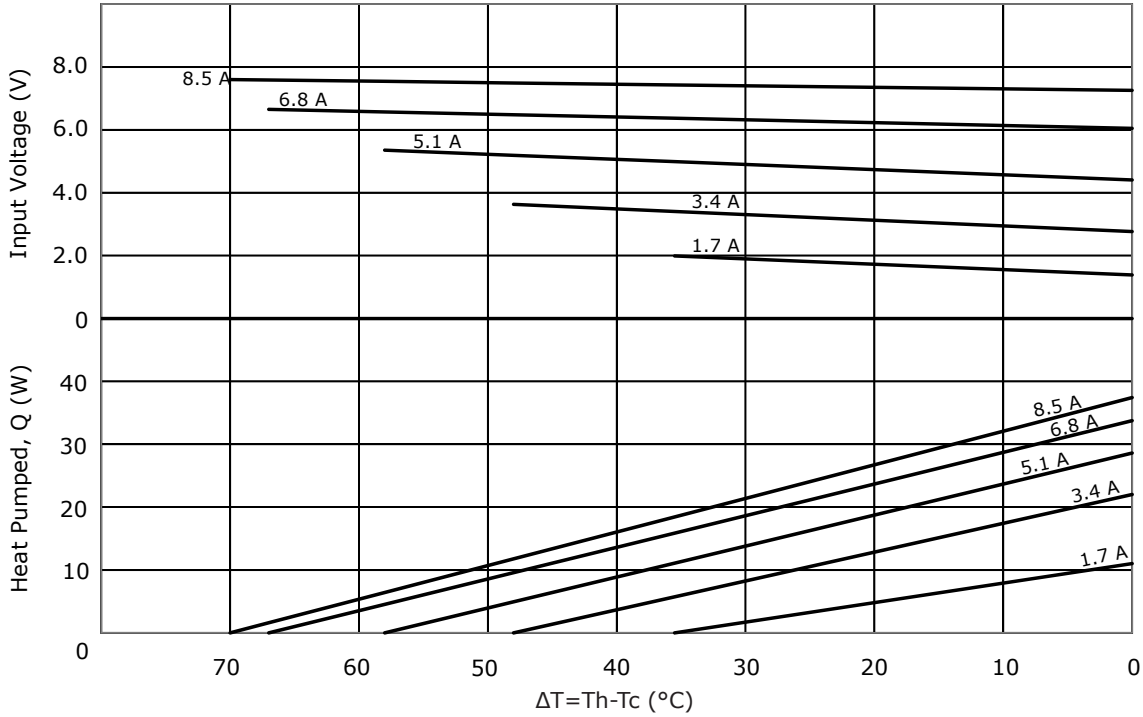

## CP854020345H PERFORMANCE (Th=50°C)

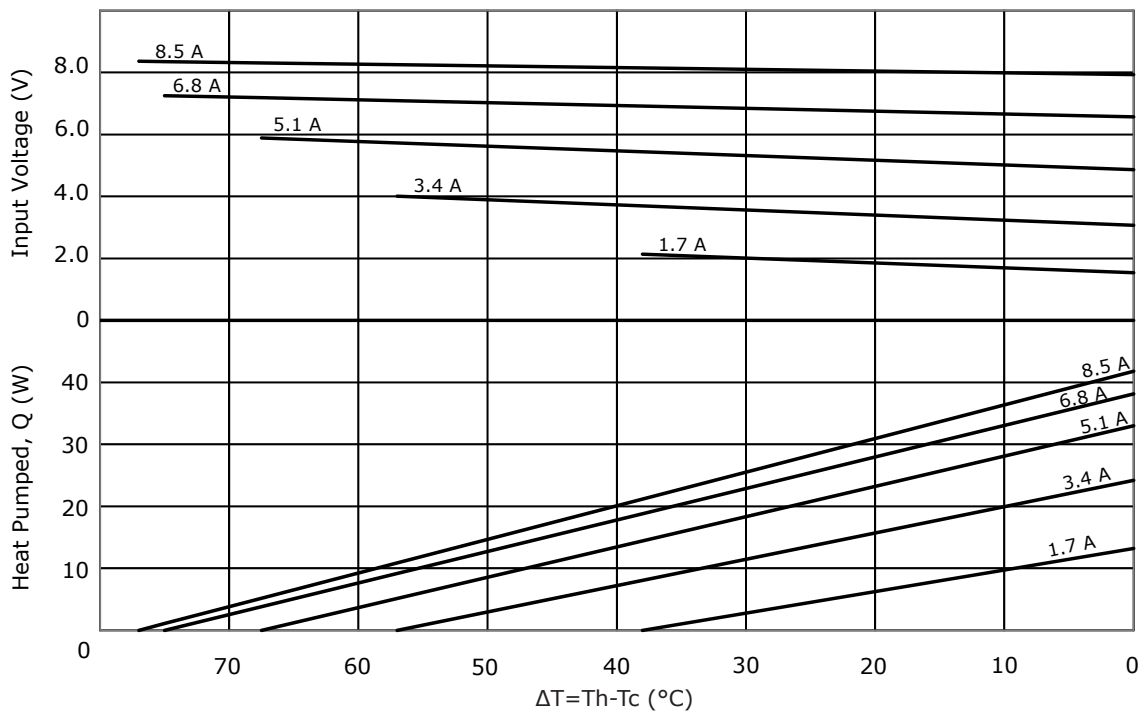

## CP854345H PERFORMANCE (Th=27°C)

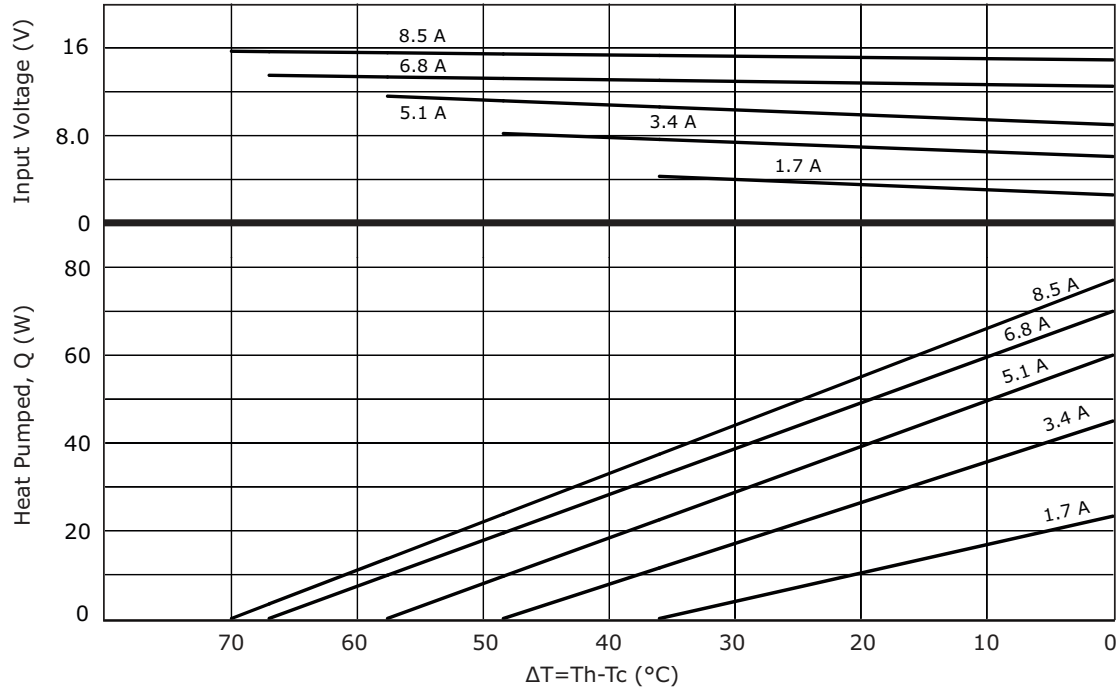

## CP854345H PERFORMANCE (Th=50°C)

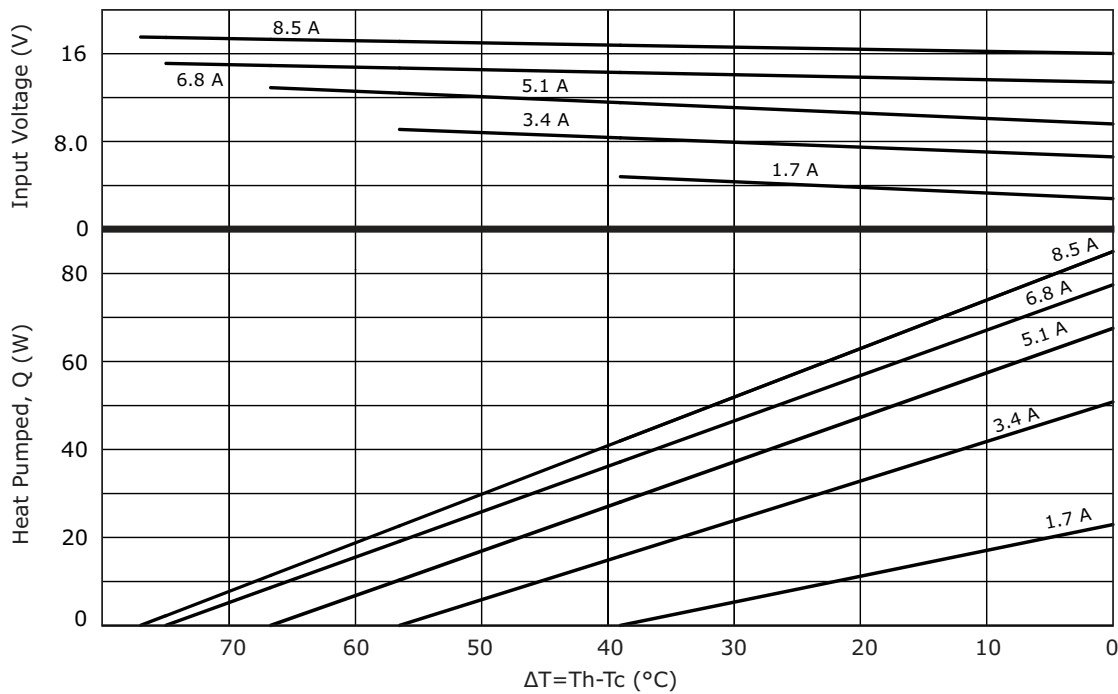

## REVISION HISTORY

rev.	description	date
1.0	initial release	09/08/2016
1.01	updated datasheet	09/25/2017
1.02	added new models	05/21/2018
1.03	added model CP8530345, brand update	10/18/2019
1.04	logo, datasheet style update	08/05/2022

The revision history provided is for informational purposes only and is believed to be accurate.



CUI Devices offers a one (1) year limited warranty. Complete warranty information is listed on our website.

CUI Devices reserves the right to make changes to the product at any time without notice. Information provided by CUI Devices is believed to be accurate and reliable. However, no responsibility is assumed by CUI Devices for its use, nor for any infringements of patents or other rights of third parties which may result from its use.

CUI Devices products are not authorized or warranted for use as critical components in equipment that requires an extremely high level of reliability. A critical component is any component of a life support device or system whose failure to perform can be reasonably expected to cause the failure of the life support device or system, or to affect its safety or effectiveness.

[cuidevices.com](http://cuidevices.com)