

MOSFET – N-Channel, POWERTRENCH®

80 V, 50 A, 13.4 mΩ

FDMS86380-F085

Features

- Typ $R_{DS(on)}$ = 11.3 mΩ at $V_{GS} = 10$ V; $I_D = 50$ A
- Typ $Q_{g(tot)}$ = 20 nC at $V_{GS} = 10$ V; $I_D = 50$ A
- UIS Capability
- AEC-Q101 Qualified and PPAP Capable
- This Device is Pb-Free, Halogen Free/BFR Free and is RoHS Compliant

Applications

- Automotive Engine Control
- PowerTrain Management
- Solenoid and Motor Drivers
- Electronic Steering
- Integrated Starter/Alternator
- Distributed Power Architectures and VRM
- Primary Switch for 12 V Systems

MAXIMUM RATINGS ($T_J = 25^\circ\text{C}$ unless otherwise noted)

Parameter	Symbol	Value	Unit
Drain-to-Source Voltage	V_{DSS}	80	V
Gate-to-Source Voltage	V_{GS}	± 20	V
Continuous Drain Current ($V_{GS} = 10$ V) (Note 1)	I_D	50	A
Pulsed Drain Current		See Figure 4	
Single Pulse Avalanche Energy (Note 2)	E_{AS}	16	mJ
Power Dissipation	P_D	75	W
Derate above 25°C		0.5	
Operating and Storage Temperature	T_J, T_{STG}	-55 to +175	°C
Thermal Resistance (Junction-to-Case)	$R_{\theta JC}$	2	°C/W
Maximum Thermal Resistance (Junction-to-Ambient) (Note 3)	$R_{\theta JA}$	50	°C/W

Stresses exceeding those listed in the Maximum Ratings table may damage the device. If any of these limits are exceeded, device functionality should not be assumed, damage may occur and reliability may be affected.

1. Current is limited by bondwire configuration.
2. Starting $T_J = 25^\circ\text{C}$, $L = 20$ μH, $I_{AS} = 40$ A, $V_{DD} = 80$ V during inductor charging and $V_{DD} = 0$ V during time in avalanche.
3. $R_{\theta JA}$ is the sum of the junction-to-case and case-to-ambient thermal resistance where the case thermal reference is defined as the solder mounting surface of the drain pins. $R_{\theta JC}$ is guaranteed by design while $R_{\theta JA}$ is determined by the user's board design. The maximum rating presented here is based on mounting on a 1 in² pad of 2 oz copper.

$V_{(BR)DSS}$	$R_{DS(ON)}$ MAX	I_D MAX
80 V	13.4 mΩ @ 10 V	50 A

ELECTRICAL CONNECTION

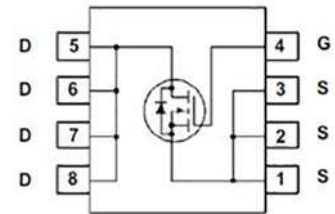

N-Channel MOSFET

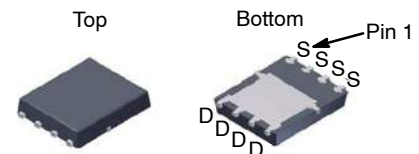

PQFN8
CASE 483BJ

MARKING DIAGRAM

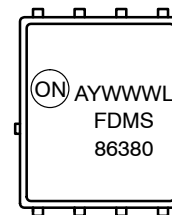

A = Assembly Location
WL = Wafer Lot
Y = Year
WW = Work Week
FDMS86380 = Specific Device Code

ORDERING INFORMATION

Device	Package	Shipping†
FDMS86380-F085	PQFN8 (Power 56) (Pb-Free)	3000 / Tape & Reel

†For information on tape and reel specifications, including part orientation and tape sizes, please refer to our Tape and Reel Packaging Specification Brochure, BRD8011/D.

FDMS86380-F085

ELECTRICAL CHARACTERISTICS ($T_J = 25^\circ\text{C}$ unless otherwise specified)

Symbol	Parameter	Conditions	Min	Typ	Max	Unit
--------	-----------	------------	-----	-----	-----	------

OFF CHARACTERISTICS

B_{VDSS}	Drain-to-Source Breakdown Voltage	$I_D = 250 \mu\text{A}$, $V_{GS} = 0 \text{ V}$	80	-	-	V	
I_{DSS}	Drain-to-Source Leakage Current	$V_{DS} = 80 \text{ V}$, $V_{GS} = 0 \text{ V}$	$T_J = 25^\circ\text{C}$	-	-	1	μA
			$T_J = 175^\circ\text{C}$ (Note 4)	-	-	1	mA
I_{GSS}	Gate-to-Source Leakage Current	$V_{GS} = \pm 20 \text{ V}$	-	-	± 100	nA	

ON CHARACTERISTICS

$V_{GS(th)}$	Gate-to-Source Threshold Voltage	$V_{GS} = V_{DS}$, $I_D = 250 \mu\text{A}$	2.0	3.0	4.0	V	
$R_{DS(on)}$	Drain-to-Source On-Resistance	$I_D = 50 \text{ A}$, $V_{GS} = 10 \text{ V}$	$T_J = 25^\circ\text{C}$	-	11.3	13.4	$\text{m}\Omega$
			$T_J = 175^\circ\text{C}$ (Note 4)	-	25.3	30.0	

DYNAMIC CHARACTERISTICS

C_{iss}	Input Capacitance	$V_{DS} = 40 \text{ V}$, $V_{GS} = 0 \text{ V}$, $f = 1 \text{ MHz}$	-	1440	-	pF	
C_{oss}	Output Capacitance		-	300	-		
C_{rss}	Reverse Transfer Capacitance		-	14	-		
R_g	Gate Resistance	$f = 1 \text{ MHz}$	-	2.0	-	Ω	
$Q_{g(tot)}$	Total Gate Charge	$V_{GS} = 0$ to 10 V	$V_{DD} = 64 \text{ V}$, $I_D = 50 \text{ A}$	-	20	30	nC
$Q_{g(th)}$	Threshold Gate Charge	$V_{GS} = 0$ to 2 V		-	2.7	-	
Q_{gs}	Gate-to-Source Gate Charge			-	8.8	-	
Q_{gd}	Gate-to-Drain "Miller" Charge			-	4.4	-	

SWITCHING CHARACTERISTICS

t_{on}	Turn-On Time	$V_{DD} = 40 \text{ V}$, $I_D = 50 \text{ A}$, $V_{GS} = 10 \text{ V}$, $R_{GEN} = 6 \Omega$	-	-	31	ns
$t_{d(on)}$	Turn-On Delay		-	13	-	
t_r	Rise Time		-	8	-	
$t_{d(off)}$	Turn-Off Delay		-	15	-	
t_f	Fall Time		-	5	-	
t_{off}	Turn-Off Time		-	-	30	

DRAIN-SOURCE DIODE CHARACTERISTICS

V_{SD}	Source-to-Drain Diode Voltage	$I_{SD} = 50 \text{ A}$, $V_{GS} = 0 \text{ V}$	-	-	1.25	V
		$I_{SD} = 25 \text{ A}$, $V_{GS} = 0 \text{ V}$	-	-	1.2	
t_{rr}	Reverse Recovery Time	$I_F = 50 \text{ A}$, $dI_{SD}/dt = 100 \text{ A}/\mu\text{s}$, $V_{DD} = 64 \text{ V}$	-	37	55	ns
Q_{rr}	Reverse Recovery Charge		-	23	35	nC

Product parametric performance is indicated in the Electrical Characteristics for the listed test conditions, unless otherwise noted. Product performance may not be indicated by the Electrical Characteristics if operated under different conditions.

4. The maximum value is specified by design at $T_J = 175^\circ\text{C}$. Product is not tested to this condition in production

TYPICAL CHARACTERISTICS

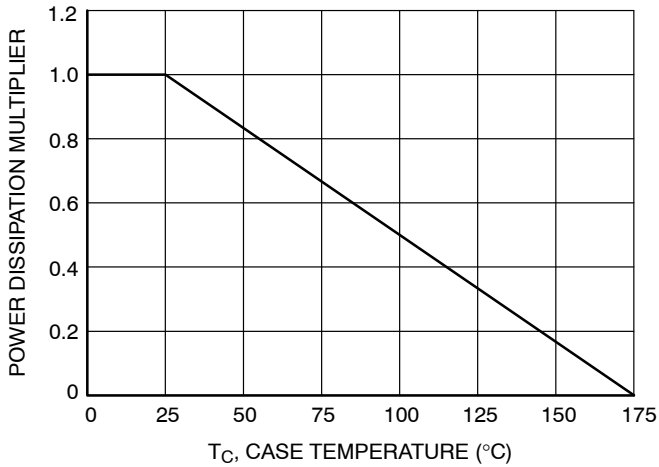

Figure 1. Normalized Power Dissipation vs. Case Temperature

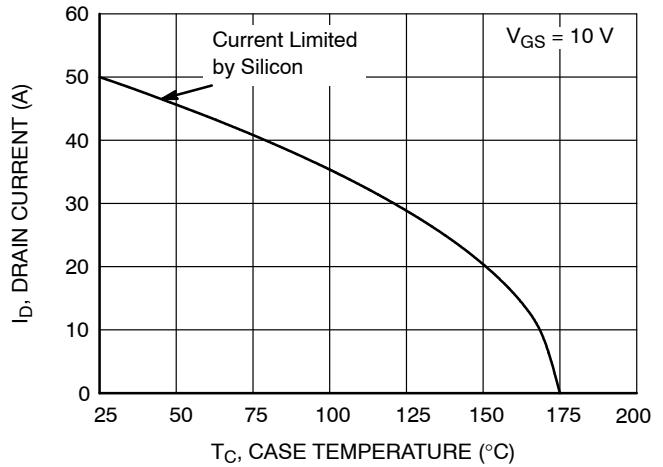

Figure 2. Maximum Continuous Drain Current vs. Case Temperature

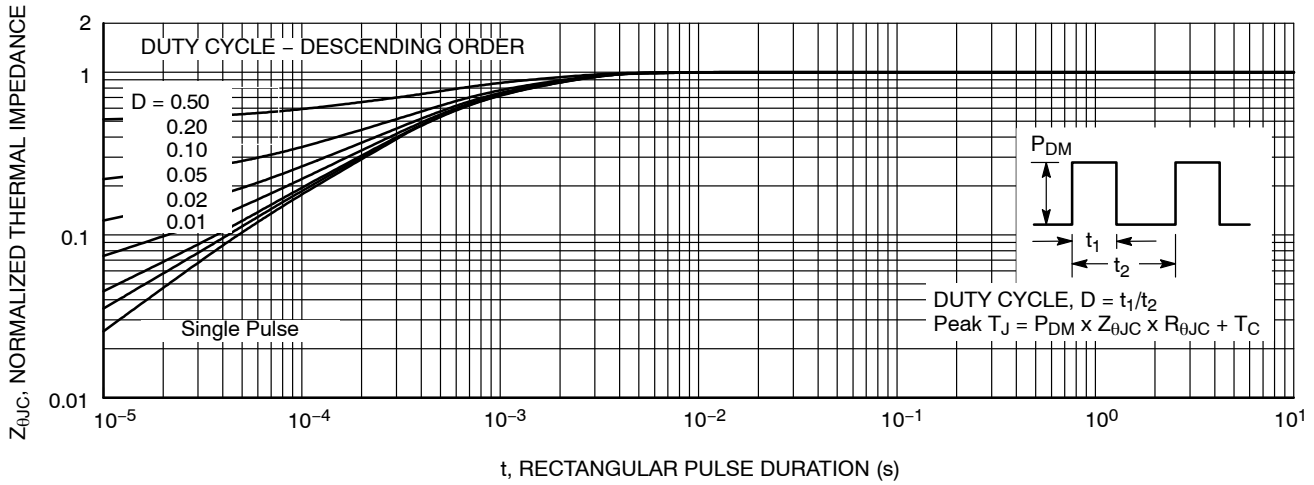

Figure 3. Normalized Maximum Transient Thermal Impedance

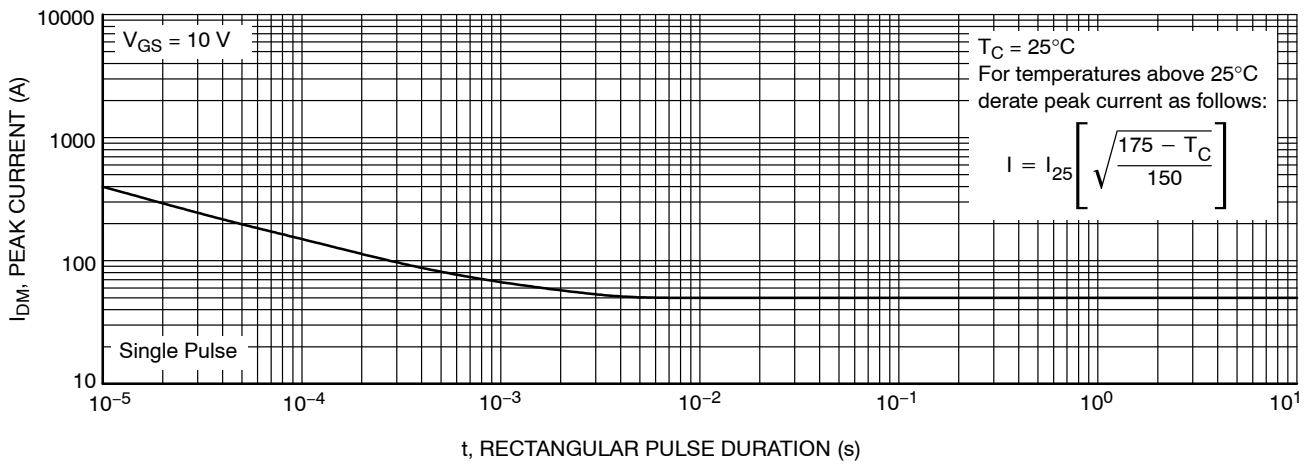

Figure 4. Peak Current Capability

TYPICAL CHARACTERISTICS (continued)

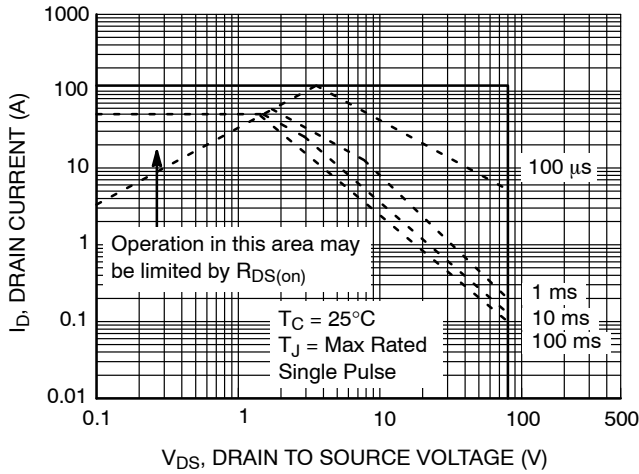
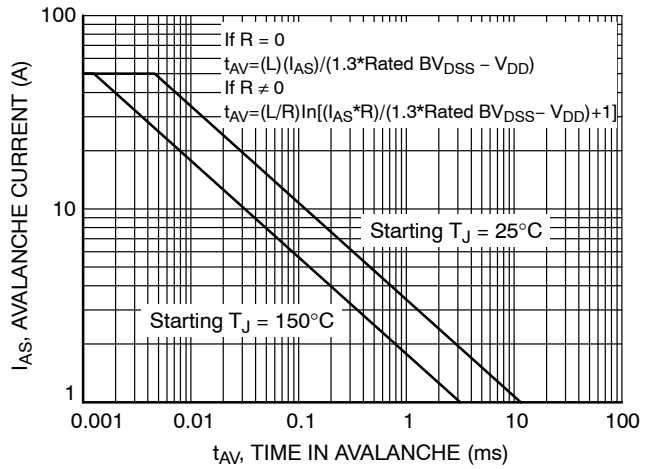

Figure 5. Forward Bias Safe Operating Area



(Note: Refer to onsemi Applications Notes [AN7514](#) and [AN7515](#))

Figure 6. Unclamped Inductive Switching Capability

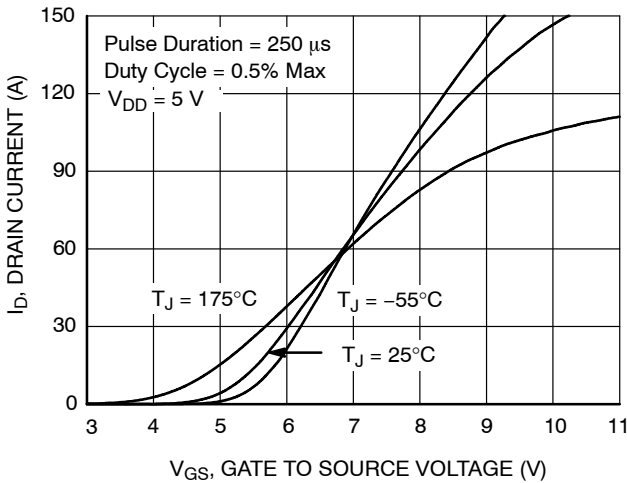

Figure 7. Transfer Characteristics

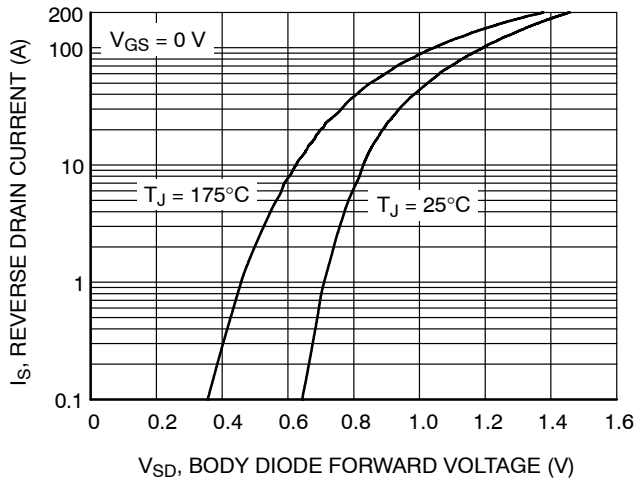

Figure 8. Forward Diode Characteristics

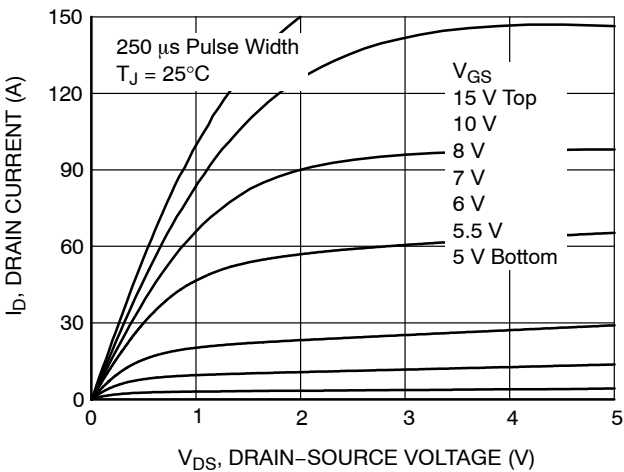

Figure 9. Saturation Characteristics

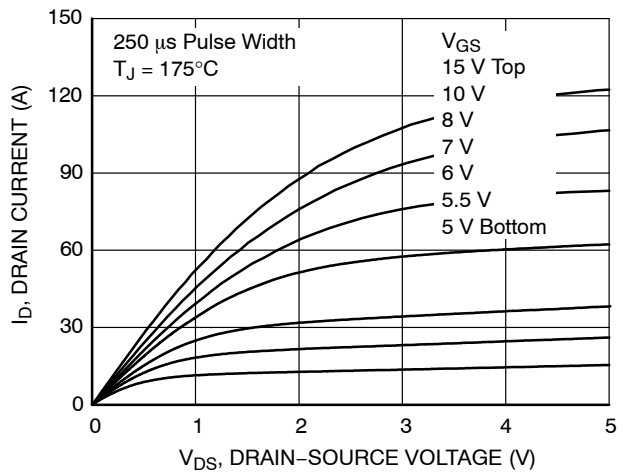

Figure 10. Saturation Characteristics

TYPICAL CHARACTERISTICS (continued)

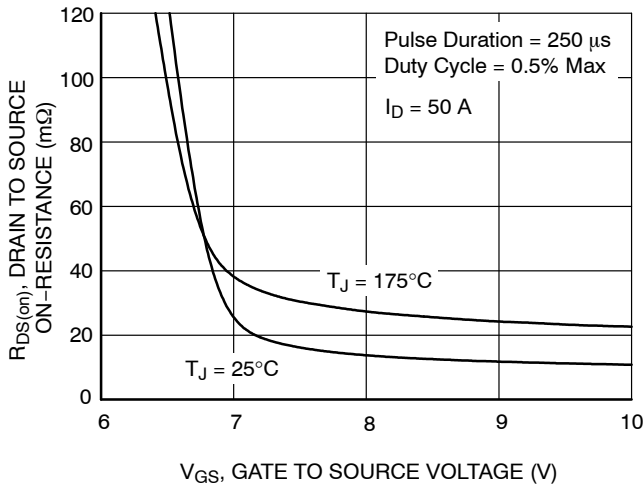

Figure 11. $R_{DS(on)}$ vs. Gate Voltage

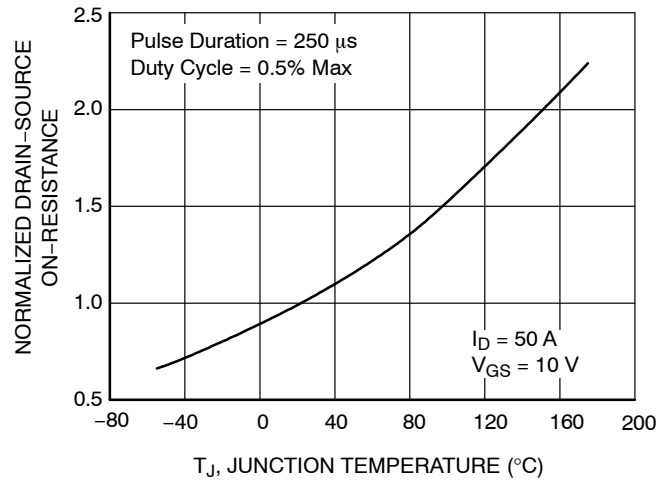

Figure 12. Normalized $R_{DS(on)}$ vs. Junction Temperature

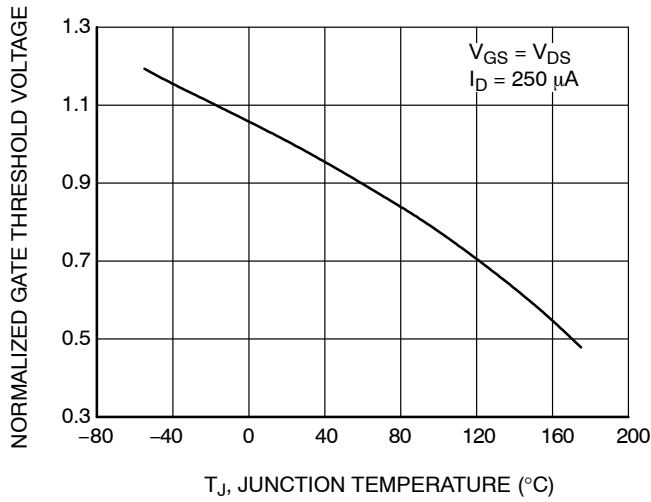

Figure 13. Normalized Gate Threshold Voltage vs. Temperature

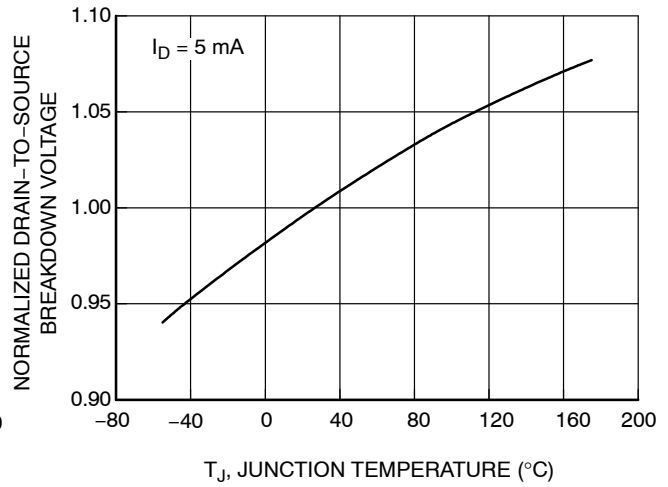

Figure 14. Normalized Drain to Source Breakdown Voltage vs. Junction Temperature

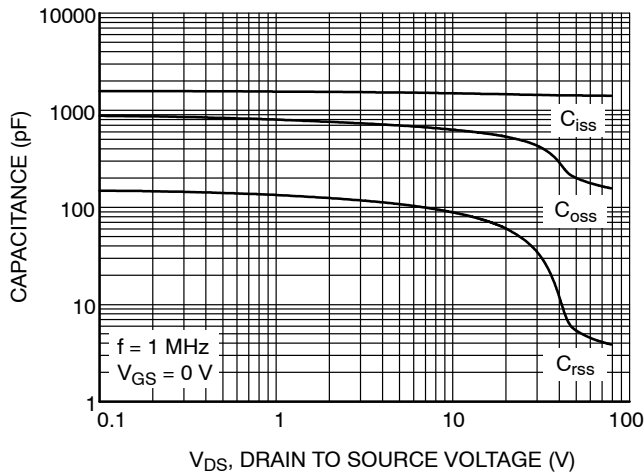

Figure 15. Capacitance vs. Drain to Source Voltage

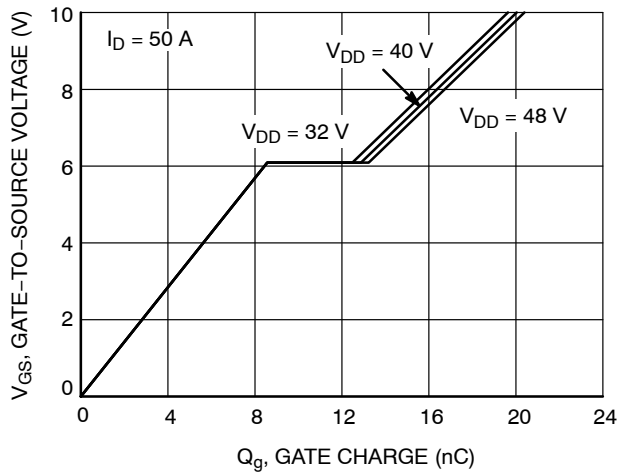

Figure 16. Gate Charge vs. Gate to Source Voltage

POWERTRENCH is a registered trademark of Semiconductor Components Industries, LLC dba "onsemi" or its affiliates and/or subsidiaries in the United States and/or other countries.

MECHANICAL CASE OUTLINE

PACKAGE DIMENSIONS

ON Semiconductor®



PQFN8 5X6, 1.27P

CASE 483BJ

ISSUE C

DATE 13 DEC 2017

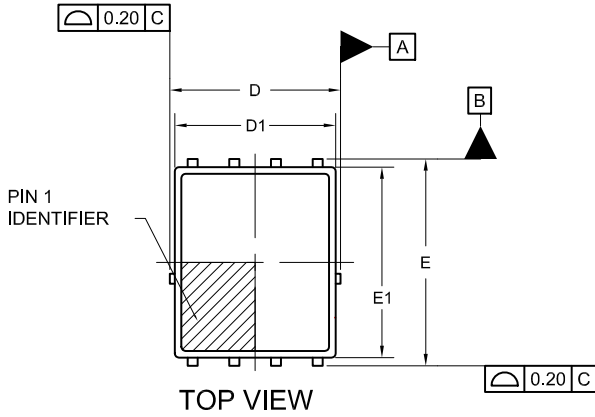

NOTES:

1. DIMENSIONING AND TOLERANCING PER ASME Y14.5M, 2009.
2. CONTROLLING DIMENSION: MILLIMETERS
3. COPLANARITY APPLIES TO THE EXPOSED PADS AS WELL AS THE TERMINALS.
4. DIMENSIONS D1 AND E1 DO NOT INCLUDE MOLD FLASH, PROTRUSIONS, OR GATE BURRS.
5. SEATING PLANE IS DEFINED BY THE TERMINALS. A1 IS DEFINED AS THE DISTANCE FROM THE SEATING PLANE TO THE LOWEST POINT ON THE PACKAGE BODY.

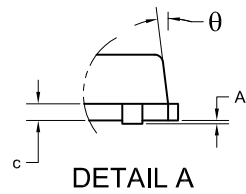

DIM	MILLIMETERS		
	MIN.	NOM.	MAX.
A	0.90	1.00	1.10
A1	0.00	0.025	0.05
b	0.31	0.41	0.51
c	0.23	0.28	0.33
D	4.90	5.00	5.10
D1	4.80	4.90	5.00
D2	3.72	3.82	3.92
E	6.20	6.30	6.40
E1	5.70	5.80	5.90
E2	3.38	3.48	3.58
E3	0.30		
E4	0.50		
e	1.27 BSC		
L	0.64	0.74	0.84
L1	0.59	0.69	0.79
theta	0°		

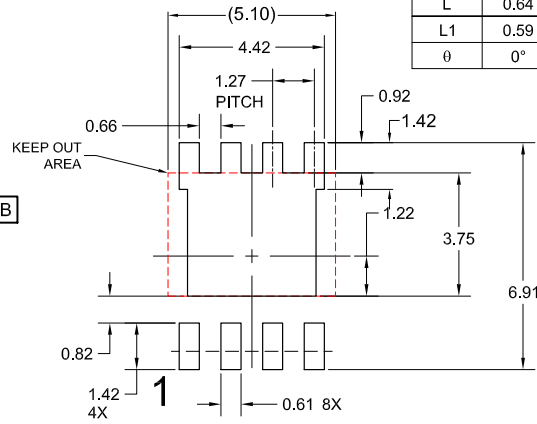
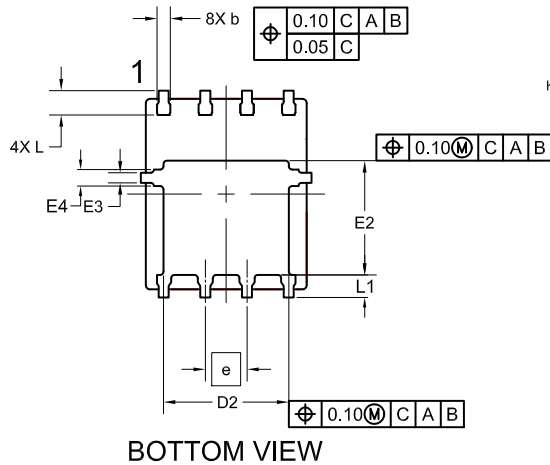
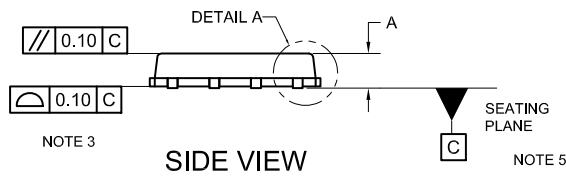

RECOMMENDED MOUNTING FOOTPRINT

DOCUMENT NUMBER:	98AON13688G	Electronic versions are uncontrolled except when accessed directly from the Document Repository. Printed versions are uncontrolled except when stamped "CONTROLLED COPY" in red.
DESCRIPTION:	PQFN8 5X6, 1.27P	PAGE 1 OF 1

ON Semiconductor and ON are trademarks of Semiconductor Components Industries, LLC dba ON Semiconductor or its subsidiaries in the United States and/or other countries. ON Semiconductor reserves the right to make changes without further notice to any products herein. ON Semiconductor makes no warranty, representation or guarantee regarding the suitability of its products for any particular purpose, nor does ON Semiconductor assume any liability arising out of the application or use of any product or circuit, and specifically disclaims any and all liability, including without limitation special, consequential or incidental damages. ON Semiconductor does not convey any license under its patent rights nor the rights of others.

onsemi, **Onsemi**, and other names, marks, and brands are registered and/or common law trademarks of Semiconductor Components Industries, LLC dba "**onsemi**" or its affiliates and/or subsidiaries in the United States and/or other countries. **onsemi** owns the rights to a number of patents, trademarks, copyrights, trade secrets, and other intellectual property. A listing of **onsemi**'s product/patent coverage may be accessed at www.onsemi.com/site/pdf/Patent-Marking.pdf. **onsemi** reserves the right to make changes at any time to any products or information herein, without notice. The information herein is provided "as-is" and **onsemi** makes no warranty, representation or guarantee regarding the accuracy of the information, product features, availability, functionality, or suitability of its products for any particular purpose, nor does **onsemi** assume any liability arising out of the application or use of any product or circuit, and specifically disclaims any and all liability, including without limitation special, consequential or incidental damages. Buyer is responsible for its products and applications using **onsemi** products, including compliance with all laws, regulations and safety requirements or standards, regardless of any support or applications information provided by **onsemi**. "Typical" parameters which may be provided in **onsemi** data sheets and/or specifications can and do vary in different applications and actual performance may vary over time. All operating parameters, including "Typicals" must be validated for each customer application by customer's technical experts. **onsemi** does not convey any license under any of its intellectual property rights nor the rights of others. **onsemi** products are not designed, intended, or authorized for use as a critical component in life support systems or any FDA Class 3 medical devices or medical devices with a same or similar classification in a foreign jurisdiction or any devices intended for implantation in the human body. Should Buyer purchase or use **onsemi** products for any such unintended or unauthorized application, Buyer shall indemnify and hold **onsemi** and its officers, employees, subsidiaries, affiliates, and distributors harmless against all claims, costs, damages, and expenses, and reasonable attorney fees arising out of, directly or indirectly, any claim of personal injury or death associated with such unintended or unauthorized use, even if such claim alleges that **onsemi** was negligent regarding the design or manufacture of the part. **onsemi** is an Equal Opportunity/Affirmative Action Employer. This literature is subject to all applicable copyright laws and is not for resale in any manner.

ADDITIONAL INFORMATION

TECHNICAL PUBLICATIONS:

Technical Library: www.onsemi.com/design/resources/technical-documentation
onsemi Website: www.onsemi.com

ONLINE SUPPORT: www.onsemi.com/support

For additional information, please contact your local Sales Representative at www.onsemi.com/support/sales