

2K x 8 Reprogrammable Registered PROM

Features

- Windowed for reprogrammability
- CMOS for optimum speed/power
- High speed
 - 15-ns address set-up
 - 10-ns clock to output
- Low power
 - 330 mW (commercial) for -25 ns
 - 660 mW (military)
- Programmable synchronous or asynchronous output enable
- On-chip edge-triggered registers
- Programmable asynchronous register (INIT)
- EPROM technology, 100% programmable
- Slim, 300-mil, 24-pin plastic or hermetic DIP

- $5V \pm 10\% V_{CC}$, commercial and military
- TTL-compatible I/O
- Direct replacement for bipolar PROMs
- Capable of withstanding greater than 2001V static discharge

Functional Description

The CY7C245A is a high-performance, 2K x 8, electrically programmable, read only memory packaged in a slim 300-mil plastic or hermetic DIP. The ceramic package may be equipped with an erasure window; when exposed to UV light the PROM is erased and can then be reprogrammed. The memory cells utilize proven EPROM floating-gate technology and byte-wide intelligent programming algorithms.

The CY7C245A replaces bipolar devices and offers the advantages of lower power,

reprogrammability, superior performance and high programming yield. The EPROM cell requires only 12.5V for the supervoltage, and low current requirements allow gang programming. The EPROM cells allow each memory location to be tested 100%, because each location is written into, erased, and repeatedly exercised prior to encapsulation. Each PROM is also tested for AC performance to guarantee that after customer programming the product will meet AC specification limits.

The CY7C245A has an asynchronous initialize function (INIT). This function acts as a 2049th 8-bit word loaded into the on-chip register. It is user programmable with any desired word, or may be used as a PRESET or CLEAR function on the outputs. INIT is triggered by a low level, not an edge.

4

Logic Block Diagram

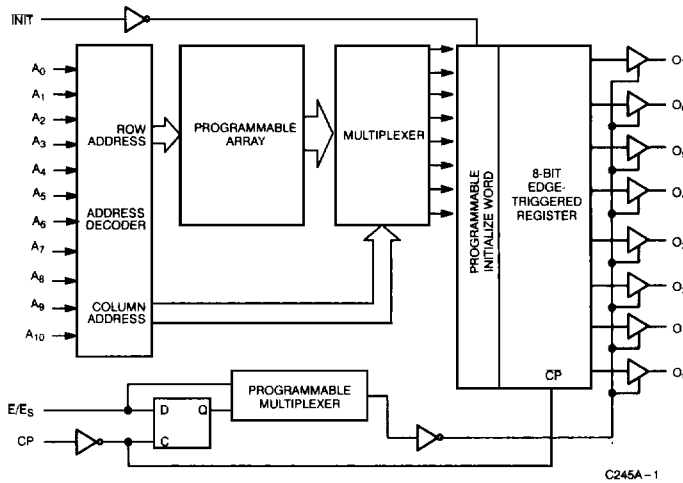

Pin Configurations

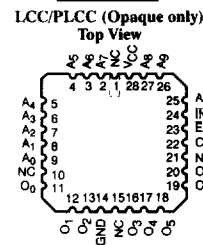
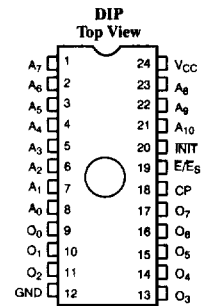

Selection Guide

| | | 7C245A-15 | 7C245A-18 | 7C245A-25 7C245AL-25 | 7C245A-35 7C245AL-35 | 7C245A-45 7C245AL-45 |
|----------------------------------|----------|------------|-----------|-------------------------|-------------------------|-------------------------|
| Minimum Address Set-Up Time (ns) | | 15 | 18 | 25 | 35 | 45 |
| Maximum Clock to Output (ns) | | 10 | 12 | 12 | 15 | 25 |
| Maximum Operating Current (mA) | Standard | Commercial | 120 | 120 | 90 | 90 |
| | | Military | | 120 | 120 | 120 |
| | L | Commercial | | | 60 | 60 |

Maximum Ratings

(Above which the useful life may be impaired. For user guidelines, not tested.)

| | |
|---|---------------------------|
| Storage Temperature | -65°C to +150°C |
| Ambient Temperature with Power Applied | -55°C to +125°C |
| Supply Voltage to Ground Potential (Pin 24 to Pin 12) | -0.5V to +7.0V |
| DC Voltage Applied to Outputs in High Z State | -0.5V to +7.0V |
| DC Input Voltage | -3.0V to +7.0V |
| DC Program Voltage (Pins 7, 18, 20) | 13.0V |
| UV Erasure | 7258 Wsec/cm ² |

| | |
|---|----------|
| Static Discharge Voltage (per MIL-STD-883, Method 3015) | > 2001V |
| Latch-Up Current | > 200 mA |

Operating Range

| Range | Ambient Temperature | V _{CC} |
|---------------------------|---------------------|-----------------|
| Commercial | 0°C to +70°C | 5V ±10% |
| Industrial ^[1] | -40°C to +85°C | 5V ±10% |
| Military ^[2] | -55°C to +125°C | 5V ±10% |

Electrical Characteristics Over the Operating Range^[3, 4]

| Parameter | Description | Test Conditions | 7C245A-15 | | 7C245A-18 | | 7C245A-25 7C245A-35 7C245A-45 | | 7C245AL-25 7C245AL-35 7C245AL-45 | | Unit | |
|------------------|--------------------------------|---|-----------|-----------------|-----------|-----------------|-------------------------------------|-----------------|--|-----------------|------|--|
| | | | Min. | Max. | Min. | Max. | Min. | Max. | Min. | Max. | | |
| V _{OH} | Output HIGH Voltage | V _{CC} = Min., I _{OH} = -4.0 mA V _{IN} = V _{IH} or V _{IL} | 2.4 | | 2.4 | | 2.4 | | 2.4 | | V | |
| V _{OL} | Output LOW Voltage | V _{CC} = Min., I _{OL} = 16 mA V _{IN} = V _{IH} or V _{IL} | | 0.4 | | 0.4 | | 0.4 | | 0.4 | V | |
| V _{IH} | Input HIGH Level | Guaranteed Input Logical HIGH Voltage for All Inputs | 2.0 | V _{CC} | 2.0 | V _{CC} | 2.0 | V _{CC} | 2.0 | V _{CC} | V | |
| V _{IL} | Input LOW Level | Guaranteed Input Logical LOW Voltage for All Inputs | | 0.8 | | 0.8 | | 0.8 | | 0.8 | V | |
| I _{Ix} | Input Leakage Current | GND ≤ V _{IN} ≤ V _{CC} | -10 | +10 | -10 | +10 | -10 | +10 | -10 | +10 | μA | |
| V _{CD} | Input Clamp Diode Voltage | Note 4 | | | | | | | | | | |
| I _{OZ} | Output Leakage Current | GND ≤ V _O ≤ V _{CC} Output Disabled ^[5] | -10 | +10 | -10 | +10 | -10 | +10 | -10 | +10 | μA | |
| I _{OS} | Output Short Circuit Current | V _{CC} = Max., V _{OUT} = 0.0V ^[6] | -20 | -90 | -20 | -90 | -20 | -90 | -20 | -90 | mA | |
| I _{CC} | Power Supply Current | V _{CC} = Max., I _{OUT} = 0 mA | Com'l | | 120 | | 120 | | 90 | | 60 | |
| | | | Mil | | 120 | | 120 | | | | | |
| V _{PP} | Programming Supply Voltage | | 12 | 13 | 12 | 13 | 12 | 13 | 12 | 13 | V | |
| I _{PP} | Programming Supply Current | | | 50 | | 50 | | 50 | | 50 | mA | |
| V _{IHP} | Input HIGH Programming Voltage | | 3.0 | | 3.0 | | 3.0 | | 3.0 | | V | |
| V _{ILP} | Input LOW Programming Voltage | | | 0.4 | | 0.4 | | 0.4 | | 0.4 | V | |

Capacitance^[4]

| Parameter | Description | Test Conditions | Max. | Unit |
|------------------|--------------------|---|------|------|
| C _{IN} | Input Capacitance | T _A = 25°C, f = 1 MHz, V _{CC} = 5.0V | 10 | pF |
| C _{OUT} | Output Capacitance | | 10 | pF |

Notes:

- Contact a Cypress representative for industrial temperature range specifications.
- T_A is the "instant on" case temperature.
- See the last page of this specification for Group A subgroup testing information.
- See the "Introduction to CMOS PROMs" section of the Cypress Data Book for general information on testing.
- For devices using the synchronous enable, the device must be clocked after applying these voltages to perform this measurement.
- For test purposes, not more than one output at a time should be shorted. Short circuit test duration should not exceed 30 seconds.

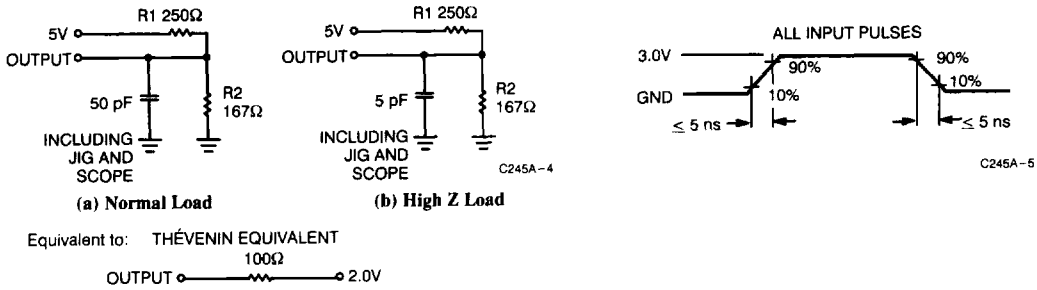
AC Test Loads and Waveforms^[3, 4]

Switching Characteristics Over Operating Range^[3, 4]

| Parameter | Description | 7C245A-15 | | 7C245A-18 | | 7C245A-25 7C245AL-25 | | 7C245A-35 7C245AL-35 | | 7C245A-45 7C245AL-45 | | Unit |
|------------------|--|-----------|------|-----------|------|-------------------------|------|-------------------------|------|-------------------------|------|------|
| | | Min. | Max. | Min. | Max. | Min. | Max. | Min. | Max. | Min. | Max. | |
| t _{SA} | Address Set-Up to Clock HIGH | 15 | | 18 | | 25 | | 35 | | 45 | | ns |
| t _{HA} | Address Hold from Clock HIGH | 0 | | 0 | | 0 | | 0 | | 0 | | ns |
| t _{CO} | Clock HIGH to Valid Output | | 10 | | 12 | | 12 | | 15 | | 25 | ns |
| t _{PWC} | Clock Pulse Width | 10 | | 12 | | 15 | | 20 | | 20 | | ns |
| t _{SES} | \bar{E}_S Set-Up to Clock HIGH | 10 | | 10 | | 12 | | 15 | | 15 | | ns |
| t _{HES} | \bar{E}_S Hold from Clock HIGH | 5 | | 5 | | 5 | | 5 | | 5 | | ns |
| t _{DI} | Delay from INIT to Valid Output | | 15 | | 20 | | 20 | | 20 | | 35 | ns |
| t _{RI} | INIT Recovery to Clock HIGH | 10 | | 12 | | 15 | | 20 | | 20 | | ns |
| t _{PWI} | INIT Pulse Width | 10 | | 12 | | 15 | | 20 | | 25 | | ns |
| t _{COS} | Valid Output from Clock HIGH ^[7] | | 15 | | 15 | | 15 | | 20 | | 30 | ns |
| t _{HZC} | Inactive Output from Clock HIGH ^[7] | | 15 | | 15 | | 15 | | 20 | | 30 | ns |
| t _{DOE} | Valid Output from \bar{E} LOW ^[8] | | 12 | | 15 | | 15 | | 20 | | 30 | ns |
| t _{HZE} | Inactive Output from \bar{E} HIGH ^[8] | | 15 | | 15 | | 15 | | 20 | | 30 | ns |

Notes:

7. Applies only when the synchronous (\bar{E}_S) function is used.

8. Applies only when the asynchronous (\bar{E}) function is used.

Operating Modes

The CY7C245A is a CMOS electrically programmable read only memory organized as 2048 words x 8 bits and is a pin-for-pin replacement for bipolar TTL fusible link PROMs. The CY7C245A incorporates a D-type, master-slave register on chip, reducing the cost and size of pipelined microprogrammed systems and applications where accessed PROM data is stored temporarily in a register. Additional flexibility is provided with a programmable synchronous (\bar{E}_S) or asynchronous (\bar{E}) output enable and asynchronous initialization (INIT).

Upon power-up the state of the outputs will depend on the programmed state of the enable function (\bar{E}_S or \bar{E}). If the synchronous enable (\bar{E}_S) has been programmed, the register will be in the set condition causing the outputs ($O_0 - O_7$) to be in the OFF or high-impedance state. If the asynchronous enable (\bar{E}) is being used, the outputs will come up in the OFF or high-impedance state only if the enable (\bar{E}) input is at a HIGH logic level. Data is read by applying the memory location to the address inputs ($A_0 - A_{10}$) and a logic LOW to the enable input. The stored data is ac-

cessed and loaded into the master flip-flops of the data register during the address set-up time. At the next LOW-to-HIGH transition of the clock (CP), data is transferred to the slave flip-flops, which drive the output buffers, and the accessed data will appear at the outputs ($O_0 - O_7$).

If the asynchronous enable (\bar{E}) is being used, the outputs may be disabled at any time by switching the enable to a logic HIGH, and may be returned to the active state by switching the enable to a logic LOW.

If the synchronous enable (\bar{E}_S) is being used, the outputs will go to the OFF or high-impedance state upon the next positive clock edge after the synchronous enable input is switched to a HIGH level. If the synchronous enable pin is switched to a logic LOW, the subsequent positive clock edge will return the output to the active state. Following a positive clock edge, the address and synchronous enable inputs are free to change since no change in the output will occur until the next LOW-to-HIGH transition of the clock. This unique feature allows the CY7C245A decoders and

Operating Modes (continued)

sense amplifiers to access the next location while previously addressed data remains stable on the outputs.

System timing is simplified in that the on-chip edge triggered register allows the PROM clock to be derived directly from the system clock without introducing race conditions. The on-chip register timing requirements are similar to those of discrete registers available in the market.

The CY7C245A has an asynchronous initialize input ($\overline{\text{INIT}}$). The initialize function is useful during power-up and time-out sequences and can facilitate implementation of other sophisticated functions such as a built-in "jump start" address. When activated, the initialize control input causes the contents of a user-pro-

grammed 2049th 8-bit word to be loaded into the on-chip register. Each bit is programmable and the initialize function can be used to load any desired combination of 1s and 0s into the register. In the unprogrammed state, activating $\overline{\text{INIT}}$ will generate a register CLEAR (all outputs LOW). If all the bits of the initialize word are programmed, activating $\overline{\text{INIT}}$ performs a register PRESET (all outputs HIGH).

Applying a LOW to the $\overline{\text{INIT}}$ input causes an immediate load of the programmed initialize word into the master and slave flip-flops of the register, independent of all other inputs, including the clock (CP). The initialize data will appear at the device outputs after the outputs are enabled by bringing the asynchronous enable (E) LOW.

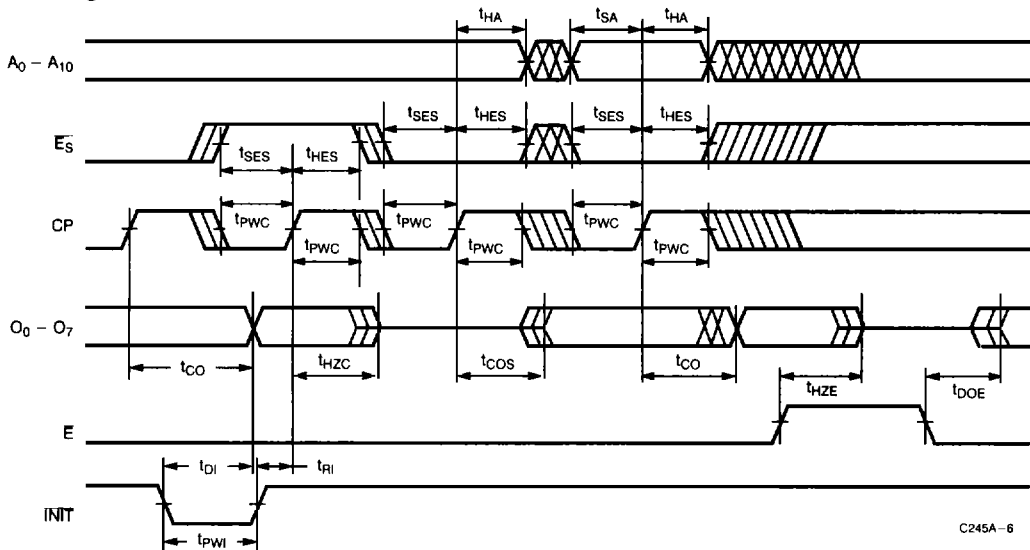
Switching Waveforms^[4]

C245A-6

Erase Characteristics

Wavelengths of light less than 4000 Å begin to erase the 7C245A. For this reason, an opaque label should be placed over the window if the PROM is exposed to sunlight or fluorescent lighting for extended periods of time.

The recommended dose for erasure is ultraviolet light with a wavelength of 2537 Å for a minimum dose (UV intensity multiplied by exposure time) of 25 Wsec/cm². For an ultraviolet lamp with a 12 mW/cm² power rating the exposure time would be approximately 35 minutes. The 7C245A needs to be within 1 inch of the lamp during erasure. Permanent damage may result if the PROM is exposed to high-intensity UV light for an extended period of time. 7258 Wsec/cm² is the recommended maximum dosage.

Programming Information

Programming support is available from Cypress as well as from a number of third-party software vendors. For detailed programming information, including a listing of software packages, please see the PROM Programming Information located at the end of

this section. Programming algorithms can be obtained from any Cypress representative.

Bit Map Data

| Programmer Address | | RAM Data |
|--------------------|-----|--------------|
| Decimal | Hex | Contents |
| 0 | 0 | Data |
| . | . | . |
| . | . | . |
| 2047 | 7FF | Data |
| 2048 | 800 | Init Byte |
| 2049 | 801 | Control Byte |

Control Byte

- (0) Asynchronous output enable (default state)
- (1) Synchronous output enable

Table 1. Mode Selection

| Mode | Pin Function ^[9] | | | | | | | | | |
|-----------------------------|-----------------------------|----------------------------------|------------------|---------------------------------|-----------------|----------------------------------|-------------------------|-----------------|---------------------------------|--|
| | Read or Output Disable | A ₁₀ - A ₄ | A ₃ | A ₂ - A ₁ | A ₀ | CP | \bar{E} , \bar{E}_S | INIT | O ₇ - O ₀ | |
| | Other | A ₁₀ - A ₄ | A ₃ | A ₂ - A ₁ | A ₀ | PGM | VFY | V _{PP} | D ₇ - D ₀ | |
| Read | | A ₁₀ - A ₄ | A ₃ | A ₂ - A ₁ | A ₀ | V _{IL} /V _{IH} | V _{IL} | V _{IH} | O ₇ - O ₀ | |
| Output Disable | | A ₁₀ - A ₄ | A ₃ | A ₂ - A ₁ | A ₀ | X | V _{IH} | V _{IH} | High Z | |
| Initialize | | A ₁₀ - A ₄ | A ₃ | A ₂ - A ₁ | A ₀ | X | V _{IL} | V _{IL} | Init. Byte | |
| Program | | A ₁₀ - A ₄ | A ₃ | A ₂ - A ₁ | A ₀ | V _{ILP} | V _{IHP} | V _{PP} | D ₇ - D ₀ | |
| Program Verify | | A ₁₀ - A ₄ | A ₃ | A ₂ - A ₁ | A ₀ | V _{IHP} | V _{ILP} | V _{PP} | O ₇ - O ₀ | |
| Program Inhibit | | A ₁₀ - A ₄ | A ₃ | A ₂ - A ₁ | A ₀ | V _{IHP} | V _{IHP} | V _{PP} | High Z | |
| Intelligent Program | | A ₁₀ - A ₄ | A ₃ | A ₂ - A ₁ | A ₀ | V _{ILP} | V _{IHP} | V _{PP} | D ₇ - D ₀ | |
| Program Synchronous Enable | | A ₁₀ - A ₄ | V _{IHP} | A ₂ - A ₁ | V _{PP} | V _{ILP} | V _{IHP} | V _{PP} | High Z | |
| Program Initialization Byte | | A ₁₀ - A ₄ | V _{ILP} | A ₂ - A ₁ | V _{PP} | V _{ILP} | V _{IHP} | V _{PP} | D ₇ - D ₀ | |
| Blank Check Zeros | | A ₁₀ - A ₄ | A ₃ | A ₂ - A ₁ | A ₀ | V _{IHP} | V _{ILP} | V _{PP} | Zeros | |

Note:

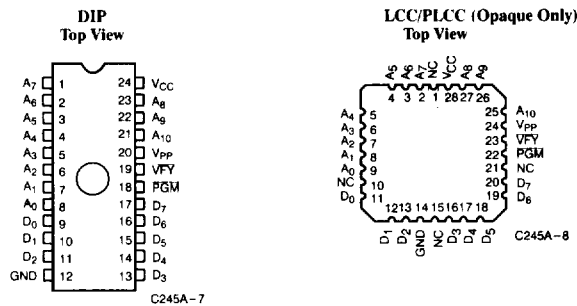
 9. X = "don't care" but not to exceed V_{CC} + 5%.

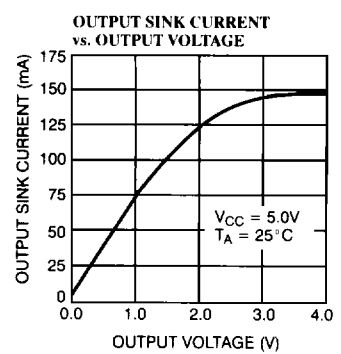
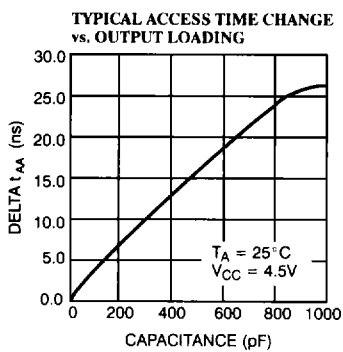
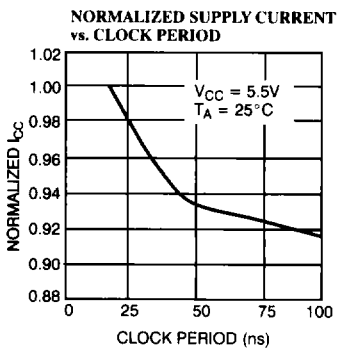
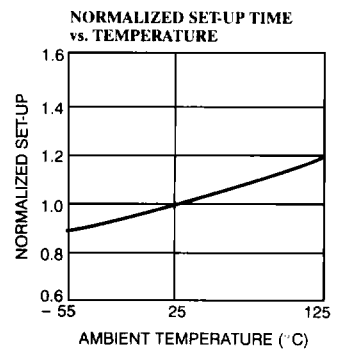
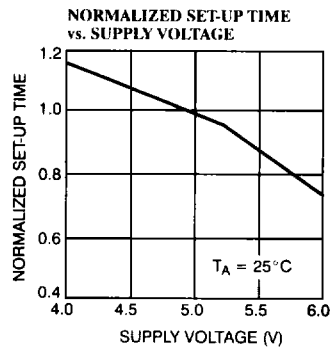
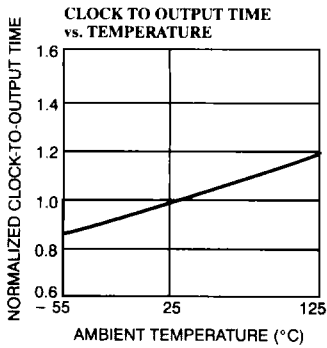
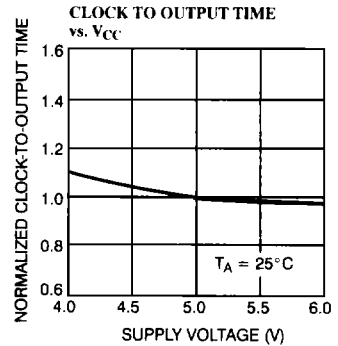
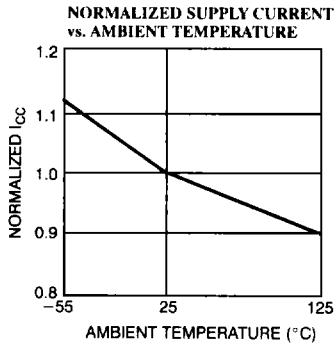
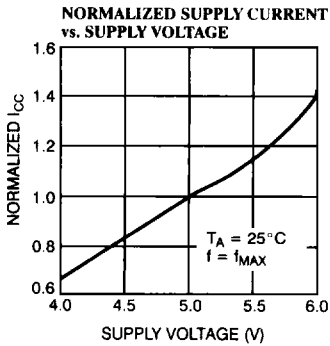
Figure 1. Programming Pinouts

Typical DC and AC Characteristics

Ordering Information^[10]

| Speed (ns) | | I _{CC} (mA) | Ordering Code | Package Type | Package Type | Operating Range |
|-----------------|-----------------|-----------------------------------|----------------|---------------------------------------|-------------------------------------|-----------------|
| t _{SA} | t _{CO} | | | | | |
| 15 | 10 | 120 | CY7C245A-15JC | J64 | 28-Lead Plastic Leaded Chip Carrier | Commercial |
| | | | CY7C245A-15PC | P13 | 24-Lead (300-Mil) Molded DIP | |
| | | | CY7C245A-15WC | W14 | 24-Lead (300-Mil) Windowed CerDIP | |
| 18 | 12 | 120 | CY7C245A-18JC | J64 | 28-Lead Plastic Leaded Chip Carrier | Commercial |
| | | | CY7C245A-18PC | P13 | 24-Lead (300-Mil) Molded DIP | |
| | | | CY7C245A-18WC | W14 | 24-Lead (300-Mil) Windowed CerDIP | |
| | | CY7C245A-18DMB | D14 | 24-Lead (300-Mil) CerDIP | Military | |
| | | CY7C245A-18LMB | L64 | 28-Square Leadless Chip Carrier | | |
| | | CY7C245A-18QMB | Q64 | 28-Pin Windowed Leadless Chip Carrier | | |
| | | CY7C245A-18TMB | T73 | 24-Lead Windowed Cerpack | | |
| CY7C245A-18WMB | W14 | 24-Lead (300-Mil) Windowed CerDIP | | | | |
| 25 | 15 | 60 | CY7C245AL-25PC | P13 | 24-Lead (300-Mil) Molded DIP | Commercial |
| | | | CY7C245AL-25WC | W14 | 24-Lead (300-Mil) Windowed CerDIP | |
| | | | CY7C245A-25JC | J64 | 28-Lead Plastic Leaded Chip Carrier | |
| | | CY7C245A-25PC | P13 | 24-Lead (300-Mil) Molded DIP | Military | |
| | | CY7C245A-25SC | S13 | 24-Lead Molded SOIC | | |
| | | CY7C245A-25WC | W14 | 24-Lead (300-Mil) Windowed CerDIP | | |
| | | CY7C245A-25DMB | D14 | 24-Lead (300-Mil) CerDIP | | |
| | | CY7C245A-25LMB | L64 | 28-Square Leadless Chip Carrier | | |
| | | CY7C245A-25QMB | Q64 | 28-Pin Windowed Leadless Chip Carrier | | |
| | | CY7C245A-25TMB | T73 | 24-Lead Windowed Cerpack | | |
| | | CY7C245A-25WMB | W14 | 24-Lead (300-Mil) Windowed CerDIP | | |
| 35 | 20 | 60 | CY7C245AL-35PC | P13 | 24-Lead (300-Mil) Molded DIP | Commercial |
| | | | CY7C245AL-35WC | W14 | 24-Lead (300-Mil) Windowed CerDIP | |
| | | | CY7C245A-35JC | J64 | 28-Lead Plastic Leaded Chip Carrier | |
| | | CY7C245A-35PC | P13 | 24-Lead (300-Mil) Molded DIP | Military | |
| | | CY7C245A-35SC | S13 | 24-Lead Molded SOIC | | |
| | | CY7C245A-35WC | W14 | 24-Lead (300-Mil) Windowed CerDIP | | |
| | | CY7C245A-35DMB | D14 | 24-Lead (300-Mil) CerDIP | | |
| | | CY7C245A-35LMB | L64 | 28-Square Leadless Chip Carrier | | |
| | | CY7C245A-35QMB | Q64 | 28-Pin Windowed Leadless Chip Carrier | | |
| | | CY7C245A-35TMB | T73 | 24-Lead Windowed Cerpack | | |
| | | CY7C245A-35WMB | W14 | 24-Lead (300-Mil) Windowed CerDIP | | |
| 45 | 25 | 60 | CY7C245A-45JC | J64 | 28-Lead Plastic Leaded Chip Carrier | Commercial |
| | | | CY7C245A-45PC | P13 | 24-Lead (300-Mil) Molded DIP | |
| | | | CY7C245A-45JC | J64 | 28-Lead Plastic Leaded Chip Carrier | |
| | | CY7C245A-45PC | P13 | 24-Lead (300-Mil) Molded DIP | Military | |
| | | CY7C245A-45SC | S13 | 24-Lead Molded SOIC | | |
| | | CY7C245A-45WC | W14 | 24-Lead (300-Mil) Windowed CerDIP | | |
| | | CY7C245A-45DMB | D14 | 24-Lead (300-Mil) CerDIP | | |
| | | CY7C245A-45LMB | L64 | 28-Square Leadless Chip Carrier | | |
| | | CY7C245A-45QMB | Q64 | 28-Pin Windowed Leadless Chip Carrier | | |
| | | CY7C245A-45TMB | T73 | 24-Lead Windowed Cerpack | | |
| | | CY7C245A-45WMB | W14 | 24-Lead (300-Mil) Windowed CerDIP | | |

Note:

10. Most of these products are available in industrial temperature range. Contact a Cypress representative for specifications and product availability.



MILITARY SPECIFICATIONS
Group A Subgroup Testing

DC Characteristics

| Parameter | Subgroups |
|-----------------|-----------|
| V _{OH} | 1, 2, 3 |
| V _{OL} | 1, 2, 3 |
| V _{IH} | 1, 2, 3 |
| V _{IL} | 1, 2, 3 |
| I _{Ix} | 1, 2, 3 |
| I _{OZ} | 1, 2, 3 |
| I _{CC} | 1, 2, 3 |

Switching Characteristics

| Parameter | Subgroups |
|-----------------|-----------------|
| t _{SA} | 7, 8, 9, 10, 11 |
| t _{HA} | 7, 8, 9, 10, 11 |
| t _{CO} | 7, 8, 9, 10, 11 |

SMD Cross Reference

| SMD Number | Suffix | Cypress Number |
|------------|--------|----------------|
| 5962-88735 | 01KX | CY7C245A-45KMB |
| 5962-88735 | 01LX | CY7C245A-45DMB |
| 5962-88735 | 013X | CY7C245A-45LMB |
| 5962-88735 | 02KX | CY7C245A-35KMB |
| 5962-88735 | 02LX | CY7C245A-35DMB |
| 5962-88735 | 023X | CY7C245A-35LMB |
| 5962-88735 | 03KX | CY7C245A-35KMB |
| 5962-88735 | 03LX | CY7C245A-35DMB |
| 5962-88735 | 033X | CY7C245A-25LMB |
| 5962-88735 | 04KX | CY7C245A-25KMB |
| 5962-88735 | 04LX | CY7C245A-25DMB |
| 5962-88735 | 043X | CY7C245A-25LMB |
| 5962-87529 | 01KX | CY7C245A-45TMB |
| 5962-87529 | 01LX | CY7C245A-45WMB |
| 5962-87529 | 013X | CY7C245A-45QMB |
| 5962-87529 | 02KX | CY7C245A-35TMB |
| 5962-87529 | 02LX | CY7C245A-35WMB |
| 5962-87529 | 023X | CY7C245A-35QMB |
| 5962-89815 | 01LX | CY7C245A-35WMB |
| 5962-89815 | 01KX | CY7C245A-35TMB |
| 5962-89815 | 013X | CY7C245A-35QMB |
| 5962-89815 | 02LX | CY7C245A-25WMB |
| 5962-89815 | 02KX | CY7C245A-25TMB |
| 5962-89815 | 023X | CY7C245A-25QMB |
| 5962-89815 | 03LX | CY7C245A-18WMB |
| 5962-89815 | 03KX | CY7C245A-18TMB |
| 5962-89815 | 033X | CY7C245A-18QMB |

Document #: 38-00074-G