

74AXP2T08-Q100

Dual supply, dual 2-input AND gate

Rev. 2 — 27 March 2019

Product data sheet

1. General description

The 74AXP2T08-Q100 is a dual supply, dual 2-input AND gate. It features four inputs (nA and nB), two outputs (nY) and dual supply pins (V_{CCI} and V_{CCO}). The inputs are referenced to V_{CCI} and the outputs are referenced to V_{CCO} . All inputs can be connected directly to V_{CCI} or GND. V_{CCI} can be supplied at any voltage between 0.7 V and 2.75 V and V_{CCO} can be supplied at any voltage between 1.2 V and 5.5 V. This feature allows voltage level translation.

Schmitt-trigger action at all inputs makes the circuit tolerant of slower input rise and fall times.

This device ensures very low static and dynamic power consumption across the entire supply range and is fully specified for partial power down applications using I_{OFF} . The I_{OFF} circuitry disables the output, preventing the potentially damaging backflow current through the device when it is powered down.

This product has been qualified to the Automotive Electronics Council (AEC) standard Q100 (Grade 1) and is suitable for use in automotive applications.

2. Features and benefits

- Automotive product qualification in accordance with AEC-Q100 (Grade 1)
 - Specified from -40 °C to +85 °C and from -40 °C to +125 °C
- Wide supply voltage range:
 - V_{CCI} : 0.7 V to 2.75 V
 - V_{CCO} : 1.2 V to 5.5 V
- Low input capacitance; $C_I = 0.6$ pF (typical)
- Low output capacitance; $C_O = 1.8$ pF (typical)
- Low dynamic power consumption; $C_{PD} = 0.5$ pF at $V_{CCI} = 1.2$ V (typical)
- Low dynamic power consumption; $C_{PD} = 7.1$ pF at $V_{CCO} = 3.3$ V (typical)
- Low static power consumption; $I_{CCI} = 0.5$ μ A (85 °C maximum)
- Low static power consumption; $I_{CCO} = 1.8$ μ A (85 °C maximum)
- High noise immunity
- Complies with JEDEC standard:
 - JESD8-12A.01 (1.1 V to 1.3 V; nA, nB inputs)
 - JESD8-11A.01 (1.4 V to 1.6 V)
 - JESD8-7A (1.65 V to 1.95 V)
 - JESD8-5A.01 (2.3 V to 2.7 V)
 - JESD8-C (2.7 V to 3.6 V; nY outputs)
 - JESD12-6 (4.5 V to 5.5 V; nY outputs)
- ESD protection:
 - MIL-STD-883, method 3015 Class 2. Exceeds 2 kV
 - HBM ANSI/ESDA/JEDEC JS-001 Class 2 exceeds 2 kV
 - CDM JESD22-C101E exceeds 1000 V
- Latch-up performance exceeds 100 mA per JESD78D Class II
- Inputs accept voltages up to 2.75 V
- Low noise overshoot and undershoot < 10% of V_{CCO}
- I_{OFF} circuitry provides partial power-down mode operation

3. Ordering information

Table 1. Ordering information

Type number	Package			Version
	Temperature range	Name	Description	
74AXP2T08DP-Q100	-40 °C to +125 °C	TSSOP10	plastic thin shrink small outline package; 10 leads; body width 3 mm	SOT552-1

4. Marking

Table 2. Marking

Type number	Marking code[1]
74AXP2T08DP-Q100	r8

[1] The pin 1 indicator is located on the lower left corner of the device, below the marking code.

5. Functional diagram

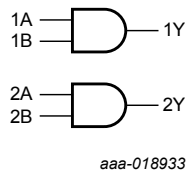

Fig. 1. Logic symbol

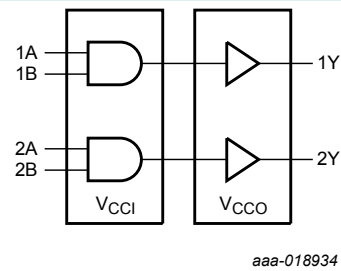

Fig. 2. Logic diagram

6. Pinning information

6.1. Pinning

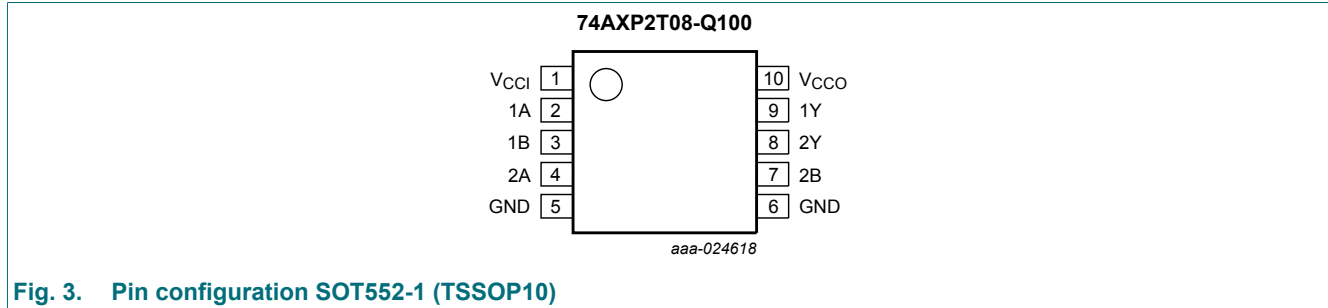

Fig. 3. Pin configuration SOT552-1 (TSSOP10)

6.2. Pin description

Table 3. Pin description

Symbol	Pin	Description
V _{CCI}	1	input supply voltage
1A, 2A	2, 4	data input
1B, 2B	3, 7	data input
GND[1]	5, 6	ground (0 V)
1Y, 2Y	9, 8	data output
V _{CCO}	10	output supply voltage

[1] All GND pins must be connected to ground (0 V).

7. Functional description

Table 4. Function table

H = HIGH voltage level; L = LOW voltage level; X = don't care.

Supply voltage		Input		Output
V _{CCI}	V _{CCO}	nA	nB	nY
0.7 V to 2.75 V	1.2 V to 5.5 V	L	X	L
0.7 V to 2.75 V	1.2 V to 5.5 V	X	L	L
0.7 V to 2.75 V	1.2 V to 5.5 V	H	H	H
GND	1.2 V to 5.5 V	X	X	Z
0.7 V to 2.75 V	GND	X	X	Z
GND	GND	X	X	Z

8. Limiting values

Table 5. Limiting values

In accordance with the Absolute Maximum Rating System (IEC 60134). Voltages are referenced to GND (ground = 0 V).

Symbol	Parameter	Conditions	Min	Max	Unit
V_{CCI}	input supply voltage		-0.5	3.3	V
V_{CCO}	output supply voltage		-0.5	6.0	V
I_{IK}	input clamping current	$V_I < 0$ V	-50	-	mA
V_I	input voltage	[1]	-0.5	3.3	V
I_{OK}	output clamping current	$V_O < 0$ V	-50	-	mA
V_O	output voltage	Active mode [1][2]	-0.5	$V_{CCO} + 0.5$	V
		Power-down or 3-state mode [1]	-0.5	6.0	V
I_O	output current	$V_O = 0$ V to V_{CCO}	-	± 25	mA
I_{CCI}	input supply current		-	50	mA
I_{CCO}	output supply current		-	50	mA
I_{GND}	ground current		-50	-	mA
T_{stg}	storage temperature		-65	+150	°C
P_{tot}	total power dissipation	$T_{amb} = -40$ °C to +125 °C [3]	-	250	mW

[1] The minimum input and output voltage ratings may be exceeded if the input and output current ratings are observed.

[2] $V_{CCO} + 0.5$ V should not exceed 6.0 V.

[3] For SOT552-1 package: P_{tot} derates linearly with 8.3 mW/K above 120 °C.

9. Recommended operating conditions

Table 6. Recommended operating conditions

Voltages are referenced to GND (ground = 0 V).

Symbol	Parameter	Conditions	Min	Max	Unit
V_{CCI}	input supply voltage		0.7	2.75	V
V_{CCO}	output supply voltage		1.2	5.5	V
V_I	input voltage		0	2.75	V
V_O	output voltage	Active mode	0	V_{CCO}	V
		Power-down or 3-state mode	0	5.5	V
T_{amb}	ambient temperature		-40	+125	°C
$\Delta t/\Delta V$	input transition rise and fall rate	$V_{CCI} = 0.7$ V to 2.75 V	0	200	ns/V

10. Static characteristics

Table 7. Static characteristics

At recommended operating conditions, unless otherwise specified; voltages are referenced to GND (ground = 0 V).

Symbol	Parameter	Conditions	T _{amb} = -40 °C to +125 °C					Unit
			Min	Typ 25 °C	Max 25 °C	Max 85 °C	Max 125 °C	
V _{IH}	HIGH-level input voltage	V _{CCI} = 0.75 V to 0.85 V	0.75V _{CCI}	-	-	-	-	V
		V _{CCI} = 1.1 V to 1.95 V	0.65V _{CCI}	-	-	-	-	V
		V _{CCI} = 2.3 V to 2.7 V	1.6	-	-	-	-	V
V _{IL}	LOW-level input voltage	V _{CCI} = 0.75 V to 0.85 V	-	-	0.25V _{CCI}	0.25V _{CCI}	0.25V _{CCI}	V
		V _{CCI} = 1.1 V to 1.95 V	-	-	0.35V _{CCI}	0.35V _{CCI}	0.35V _{CCI}	V
		V _{CCI} = 2.3 V to 2.7 V	-	-	0.7	0.7	0.7	V
V _{OH}	HIGH-level output voltage	I _O = -2 mA; V _{CCO} = 1.2 V [1]	-	1.05	-	-	-	V
		I _O = -3 mA; V _{CCO} = 1.4 V	1.05	-	-	-	-	V
		I _O = -4.5 mA; V _{CCO} = 1.65 V	1.2	-	-	-	-	V
		I _O = -8 mA; V _{CCO} = 2.3 V	1.7	-	-	-	-	V
		I _O = -10 mA; V _{CCO} = 3.0 V	2.2	-	-	-	-	V
		I _O = -12 mA; V _{CCO} = 4.5 V	3.7	-	-	-	-	V
V _{OL}	LOW-level output voltage	I _O = 2 mA; V _{CCO} = 1.2 V [1]	-	0.18	-	-	-	V
		I _O = 3 mA; V _{CCO} = 1.4 V	-	-	0.35	0.35	0.35	V
		I _O = 4.5 mA; V _{CCO} = 1.65 V	-	-	0.45	0.45	0.45	V
		I _O = 8 mA; V _{CCO} = 2.3 V	-	-	0.7	0.7	0.7	V
		I _O = 10 mA; V _{CCO} = 3.0 V	-	-	0.8	0.8	0.8	V
		I _O = 12 mA; V _{CCO} = 4.5 V	-	-	0.8	0.8	0.8	V
I _I	input leakage current	V _I = 0 V to 2.75 V; V _{CCI} = 0 V to 2.75 V [1]	-	±0.001	±0.1	±0.5	±1.0	µA
I _{OZ}	OFF-state output current	V _O = 0 V to 5.5 V; V _{CCO} = 1.2 V to 5.5 V	-	±0.001	±0.1	±0.5	±2.0	µA
I _{OFF}	power-off leakage current	input; V _I = 0 V to 2.75 V; V _{CCI} = 0 V; V _{CCO} = 0 V to 5.5 V [1]	-	±0.01	±0.1	±0.5	±2.0	µA
		output; V _O = 0 V to 5.5 V; V _{CCO} = 0 V; V _{CCI} = 0 V to 2.75 V; V _I = 0 V to 2.75 V [1]	-	±0.01	±0.1	±0.5	±2.0	µA
ΔI _{OFF}	additional power-off leakage current	input; V _I = 0 V or 2.75 V; V _{CCI} = 0 V to 0.1 V; V _{CCO} = 0 V to 5.5 V [1]	-	±0.02	±0.1	±0.5	±2.0	µA
		output; V _O = 0 V or 5.5 V; V _{CCO} = 0 V to 0.1 V; V _{CCI} = 0 V to 2.75 V; V _I = 0 V or 2.75 V [1]	-	±0.02	±0.1	±0.5	±2.0	µA

[1] Typical values are measured at V_{CCI} = V_{CCO} = 1.2 V unless otherwise specified.

Table 8. Static characteristics supply current

At recommended operating conditions, unless otherwise specified; voltages are referenced to GND (ground = 0 V).

Symbol	Parameter	Conditions	$T_{amb} = -40\text{ °C to }+125\text{ °C}$					Unit
			Typ 25 °C	Max 25 °C	Typ 85 °C	Max 85 °C	Max 125 °C	
I_{CCI}	input supply current	$V_I = 0\text{ V or }V_{CCI}$;						
		$V_{CCI} = 0.7\text{ V to }1.3\text{ V}$ [1]	1	100	10	300	500	nA
		$V_{CCI} = 1.3\text{ V to }2.75\text{ V}$ [2]	1	100	20	500	1000	nA
		$V_{CCI} = 2.75\text{ V}; V_{CCO} = 0\text{ V}$	1	100	20	500	1000	nA
		$V_{CCI} = 0\text{ V}; V_{CCO} = 5.5\text{ V}$	1	100	1	100	500	nA
I_{CCO}	output supply current	$V_I = 0\text{ V or }V_{CCI}$; $I_O = 0\text{ A}$; see Table 9						
		$V_{CCO} = 1.2\text{ V to }3.6\text{ V}$ [1]	0.001	1.0	0.01	1.2	1.3	μA
		$V_{CCO} = 3.6\text{ V to }5.5\text{ V}$ [3]	0.8	1.5	1.0	1.8	2.0	μA
		$V_{CCI} = 2.75\text{ V}; V_{CCO} = 0\text{ V}$	0.001	0.1	0.003	0.2	0.5	μA
		$V_{CCI} = 0\text{ V}; V_{CCO} = 3.6\text{ V}$	0.2	0.6	0.3	0.8	1.2	μA
	$V_{CCI} = 0\text{ V}; V_{CCO} = 5.5\text{ V}$	0.4	0.8	0.5	1.0	1.5	μA	
ΔI_{CCI}	additional input supply current	$V_I = V_{CCI} - 0.5\text{ V}; V_{CCI} = 2.5\text{ V}$	2	100	14	150	200	μA

[1] Typical values are measured at $V_{CCI} = V_{CCO} = 1.2\text{ V}$ unless otherwise specified.

[2] Typical values are measured at $V_{CCI} = V_{CCO} = 2.5\text{ V}$.

[3] Typical values are measured at $V_{CCI} = 1.2\text{ V}$ and $V_{CCO} = 5.0\text{ V}$.

Table 9. Typical output supply current (I_{CCO})

V_{CCI}	V_{CCO}							Unit
	0 V	1.2 V	1.5 V	1.8 V	2.5 V	3.3 V	5.0 V	
0 V	0	1	5	20	100	200	400	nA
0.8 V	1	10	150	200	300	500	800	nA
1.2 V	1	1	5	200	300	500	800	nA
1.5 V	1	1	5	100	300	500	800	nA
1.8 V	1	1	5	100	300	500	800	nA
2.5 V	1	1	5	100	100	500	800	nA

11. Dynamic characteristics

Table 10. Typical dynamic characteristics at $T_{amb} = 25\text{ °C}$

Voltages are referenced to GND (ground = 0 V); for test circuit see [Fig. 11](#); for waveform see [Fig. 4](#).

Symbol	Parameter	Conditions	V_{CCO}						Unit	
			1.2 V	1.5 V	1.8 V	2.5 V	3.3 V	5.0 V		
C_{PD}	power dissipation capacitance	$f_i = 1\text{ MHz}$; $R_L = \infty\ \Omega$; $V_I = 0\text{ V to }V_{CCI}$ [1]								
		input supply [2]								
		$V_{CCI} = 0.8\text{ V}$	0.4	0.4	0.4	0.4	0.4	0.4	pF	
		$V_{CCI} = 1.2\text{ V}$	0.5	0.5	0.5	0.5	0.5	0.5	pF	
		$V_{CCI} = 1.5\text{ V}$	0.5	0.5	0.5	0.5	0.5	0.5	pF	
		$V_{CCI} = 1.8\text{ V}$	0.6	0.6	0.6	0.6	0.6	0.6	pF	
		$V_{CCI} = 2.5\text{ V}$	0.8	0.8	0.8	0.8	0.8	0.8	pF	
		output supply [3]								
		$V_{CCI} = 0.8\text{ V}$	6.7	6.8	6.8	6.9	7.5	9.5	pF	
		$V_{CCI} = 1.2\text{ V}$	6.8	6.9	7.0	7.0	7.1	7.6	pF	
		$V_{CCI} = 1.5\text{ V}$	6.9	6.9	6.9	7.0	7.1	7.6	pF	
		$V_{CCI} = 1.8\text{ V}$	6.9	6.9	6.9	7.0	7.2	7.6	pF	
$V_{CCI} = 2.5\text{ V}$	6.9	7.0	7.0	7.0	7.2	7.6	pF			
C_I	input capacitance	$V_I = 0\text{ V or }V_{CCI}$; $V_{CCI} = 0\text{ V to }2.7\text{ V}$	0.6	0.6	0.6	0.6	0.6	0.6	pF	
C_O	output capacitance	$V_O = 0\text{ V}$; $V_{CCO} = 0\text{ V}$	1.8	1.8	1.8	1.8	1.8	1.8	pF	

[1] C_{PD} is used to determine the dynamic power dissipation (P_D in μW).

[2] Power dissipated from input supply (V_{CCI})

$$P_D = C_{PD} \times V_{CCI}^2 \times f_i \times N \text{ where:}$$

C_{PD} = power dissipation capacitance of the input supply; V_{CCI} = input supply voltage in V; f_i = input frequency in MHz; N = number of inputs switching.

[3] Power dissipated from output supply (V_{CCO})

$$P_D = (C_L + C_{PD}) \times V_{CCO}^2 \times f_o \text{ where:}$$

C_L = load capacitance in pF; C_{PD} = power dissipation capacitance of the output supply; V_{CCO} = output supply voltage in V; f_o = output frequency in MHz.

Table 11. Dynamic characteristics

Voltages are referenced to GND (ground = 0 V); for test circuit, see Fig. 11; for waveform, see Fig. 4.

Symbol	Parameter	Conditions	V _{CC0} [1]															Unit			
			1.2 V			1.5 V ± 0.1 V			1.8 V ± 0.15 V			2.5 V ± 0.2 V			3.3 V ± 0.3 V				5.0 V ± 0.5 V		
			Typ	Min	Max	Typ	Min	Max	Typ	Min	Max	Typ	Min	Max	Typ	Min	Max		Typ	Min	Max
T_{amb} = 25 °C																					
t _{pd}	propagation delay	nA, nB to nY [2]																			
		V _{CCI} = 0.75 V to 0.85 V	23	3	18	73	3	16	69	2	14	69	2	14	77	2	15	89	ns		
		V _{CCI} = 1.1 V to 1.3 V	16.9	3.1	10.8	19.9	2.8	8.7	15.9	2.4	6.9	10.9	2.2	6.3	9.6	2.1	6.0	9.1	ns		
		V _{CCI} = 1.4 V to 1.6 V	16.0	2.8	9.9	18.2	2.5	7.8	13.2	2.1	6.0	9.1	2.0	5.4	8.2	1.9	5.0	7.7	ns		
		V _{CCI} = 1.65 V to 1.95 V	15.6	2.7	9.5	17.3	2.4	7.3	11.8	2.0	5.6	8.6	1.8	4.9	7.6	1.8	4.6	7.2	ns		
V _{CCI} = 2.3 V to 2.7 V	15.2	2.5	9.0	16.8	2.2	6.9	11.0	1.9	5.1	8.0	1.7	4.5	7.0	1.6	4.1	6.5	ns				
T_{amb} = -40 °C to +85 °C																					
t _{pd}	propagation delay	nA, nB to nY [2]																			
		V _{CCI} = 0.75 V to 0.85 V	23	3	18	148	3	16	145	2	14	164	2	14	191	2	15	222	ns		
		V _{CCI} = 1.1 V to 1.3 V	16.9	3.1	10.8	19.9	2.8	8.7	15.9	2.4	6.9	10.9	2.2	6.3	9.6	2.1	6.0	9.1	ns		
		V _{CCI} = 1.4 V to 1.6 V	16.0	2.8	9.9	18.2	2.5	7.8	13.2	2.1	6.0	9.1	2.0	5.4	8.2	1.9	5.0	7.7	ns		
		V _{CCI} = 1.65 V to 1.95 V	15.6	2.7	9.5	17.3	2.4	7.3	11.8	2.0	5.6	8.6	1.8	4.9	7.6	1.8	4.6	7.2	ns		
V _{CCI} = 2.3 V to 2.7 V	15.2	2.5	9.0	16.8	2.2	6.9	11.0	1.9	5.1	8.0	1.7	4.5	7.0	1.6	4.1	6.5	ns				
T_{amb} = -40 °C to +125 °C																					
t _{pd}	propagation delay	nA, nB to nY [2]																			
		V _{CCI} = 0.75 V to 0.85 V	23	3	18	148	3	16	145	2	14	164	2	14	191	2	15	222	ns		
		V _{CCI} = 1.1 V to 1.3 V	16.9	3.1	10.8	20.2	2.8	8.7	16.7	2.4	6.9	14.2	2.2	6.3	12.2	2.1	6.0	11.2	ns		
		V _{CCI} = 1.4 V to 1.6 V	16.0	2.8	9.9	19.1	2.5	7.8	15.6	2.1	6.0	11.1	2.0	5.4	10.0	1.9	5.0	9.4	ns		
		V _{CCI} = 1.65 V to 1.95 V	15.6	2.7	9.5	18.2	2.4	7.3	14.7	2.0	5.6	10.5	1.8	4.9	9.6	1.8	4.6	8.9	ns		
V _{CCI} = 2.3 V to 2.7 V	15.2	2.5	9.0	17.2	2.2	6.9	13.7	1.9	5.1	9.8	1.7	4.5	8.8	1.6	4.1	8.1	ns				
t _t	transition time	V _{CCI} = 0.75 V to 2.7 V [2]	-	1.0	-	-	1.0	-	-	1.0	-	-	1.0	-	-	1.0	-	-	ns		

[1] Typical values are measured at nominal supply voltages and T_{amb} = +25 °C.

[2] t_{pd} is the same as t_{pLH} and t_{pHL}; t_t is the same as t_{tHL} and t_{tLH}.

12. Waveform, graphs and test circuit

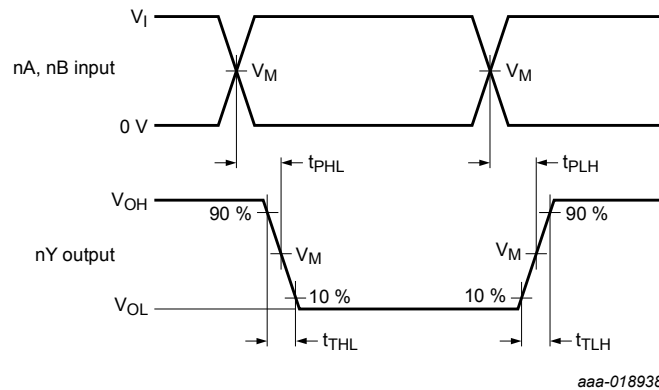

Measurement points are given in [Table 12](#).

V_{OL} and V_{OH} are typical output voltage levels that occur with the output load.

Fig. 4. Input nA, nB to output nY propagation delay times and output transition times

Table 12. Measurement points

Supply voltage		Output	Input	
V_{CCI}	V_{CCO}	V_M	V_M	V_I
0.75 V to 2.7 V	1.2 V to 5.5 V	$0.5V_{CCO}$	$0.5V_{CCI}$	V_{CCI}

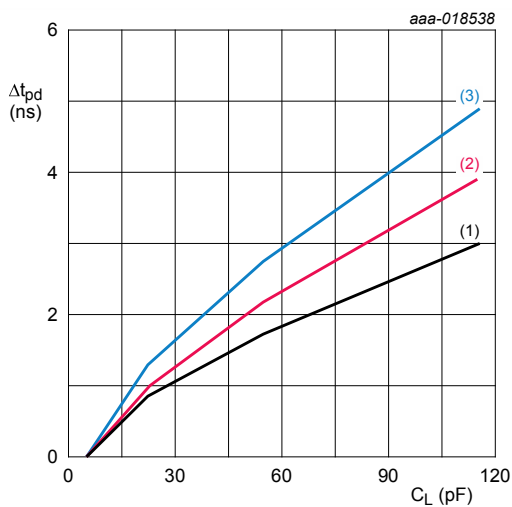

$T_{amb} = -40\text{ °C}$ to $+85\text{ °C}$ unless otherwise specified.

(1) Minimum: $V_{CCO} = 5.5\text{ V}$

(2) Typical: $T_{amb} = 25\text{ °C}$; $V_{CCO} = 5\text{ V}$

(3) Maximum: $V_{CCO} = 4.5\text{ V}$

Fig. 5. Additional propagation delay versus load capacitance

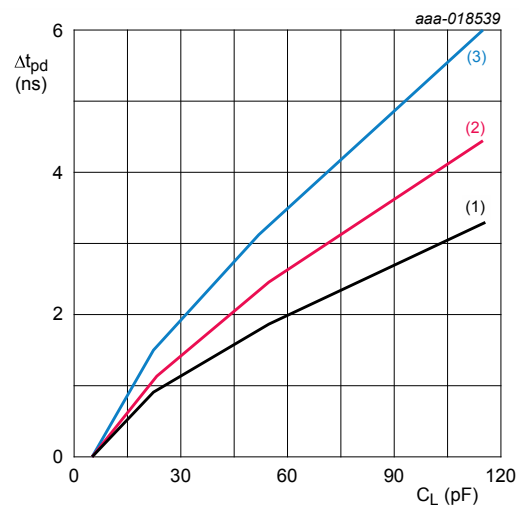

$T_{amb} = -40\text{ °C}$ to $+85\text{ °C}$ unless otherwise specified.

(1) Minimum: $V_{CCO} = 3.6\text{ V}$

(2) Typical: $T_{amb} = 25\text{ °C}$; $V_{CCO} = 3.3\text{ V}$

(3) Maximum: $V_{CCO} = 3\text{ V}$

Fig. 6. Additional propagation delay versus load capacitance

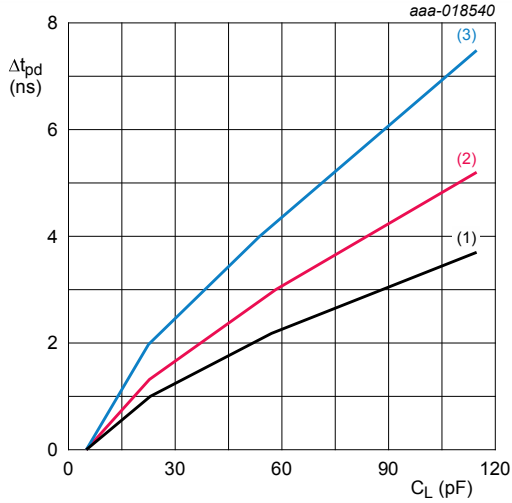

$T_{amb} = -40\text{ °C to }+85\text{ °C}$ unless otherwise specified.

- (1) Minimum: $V_{CCO} = 2.7\text{ V}$
- (2) Typical: $T_{amb} = 25\text{ °C}; V_{CCO} = 2.5\text{ V}$
- (3) Maximum: $V_{CCO} = 2.3\text{ V}$

Fig. 7. Additional propagation delay versus load capacitance

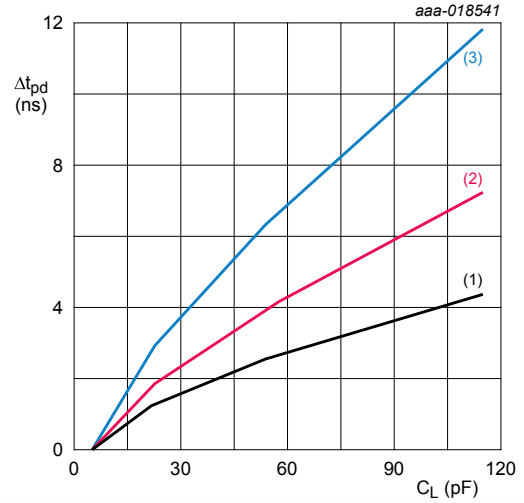

$T_{amb} = -40\text{ °C to }+85\text{ °C}$ unless otherwise specified.

- (1) Minimum: $V_{CCO} = 1.95\text{ V}$
- (2) Typical: $T_{amb} = 25\text{ °C}; V_{CCO} = 1.8\text{ V}$
- (3) Maximum: $V_{CCO} = 1.65\text{ V}$

Fig. 8. Additional propagation delay versus load capacitance

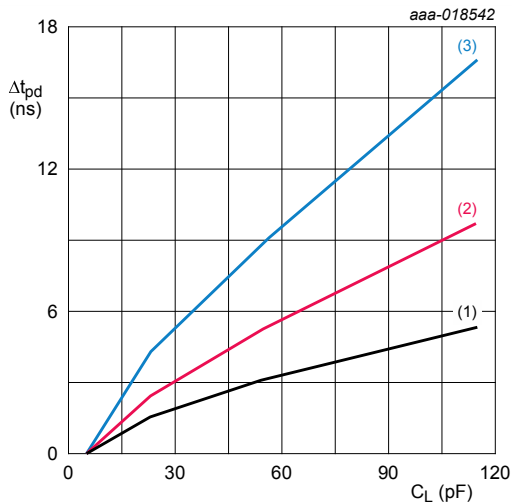

$T_{amb} = -40\text{ °C to }+85\text{ °C}$ unless otherwise specified.

- (1) Minimum: $V_{CCO} = 1.6\text{ V}$
- (2) Typical: $T_{amb} = 25\text{ °C}; V_{CCO} = 1.5\text{ V}$
- (3) Maximum: $V_{CCO} = 1.4\text{ V}$

Fig. 9. Additional propagation delay versus load capacitance

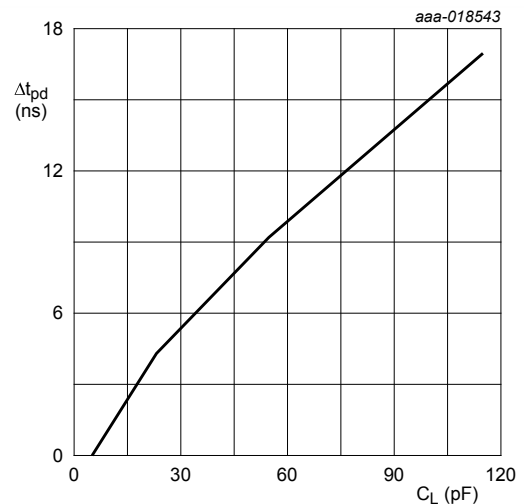

$T_{amb} = 25\text{ °C}; V_{CCO} = 1.2\text{ V}$.

Fig. 10. Additional propagation delay versus load capacitance

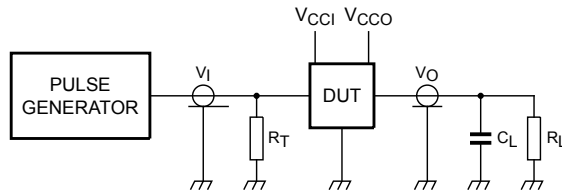
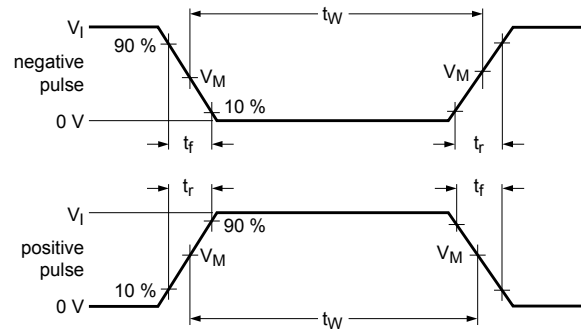

aaa-018544

Test data is given in [Table 13](#).

Definitions test circuit:

R_T = Termination resistance should be equal to output impedance Z_o of the pulse generator.

C_L = Load capacitance including jig and probe capacitance.

R_L = Load resistance.

Fig. 11. Test circuit for measuring switching times

Table 13. Test data

Supply voltage		Load		Input	
V_{CCI}	V_{CCO}	C_L	R_L	t_r, t_f	V_I
0.75 V to 2.7 V	1.2 V to 5.5 V	5 pF	5 k Ω	≤ 3.0 ns	V_{CCI}

13. Package outline

TSSOP10: plastic thin shrink small outline package; 10 leads; body width 3 mm

SOT552-1

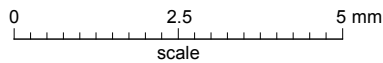
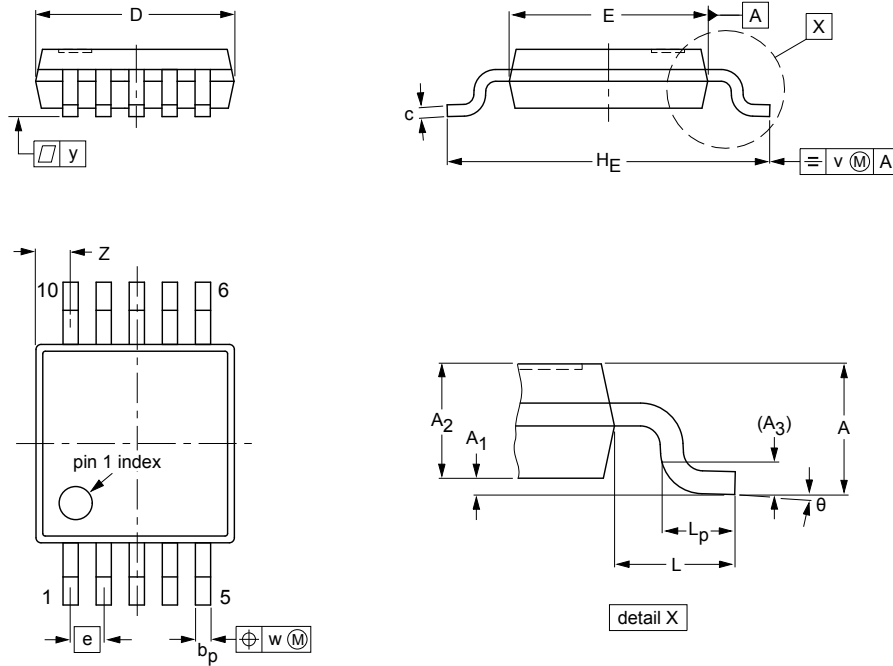

DIMENSIONS (mm are the original dimensions)

UNIT	A max.	A ₁	A ₂	A ₃	b _p	c	D ⁽¹⁾	E ⁽²⁾	e	H _E	L	L _p	v	w	y	Z ⁽¹⁾	θ
mm	1.1	0.15 0.05	0.95 0.80	0.25	0.30 0.15	0.23 0.15	3.1 2.9	3.1 2.9	0.5	5.0 4.8	0.95	0.7 0.4	0.1	0.1	0.1	0.67 0.34	6° 0°

Notes

1. Plastic or metal protrusions of 0.15 mm maximum per side are not included.
2. Plastic or metal protrusions of 0.25 mm maximum per side are not included.

OUTLINE VERSION	REFERENCES				EUROPEAN PROJECTION	ISSUE DATE
	IEC	JEDEC	JEITA			
SOT552-1						99-07-29 03-02-18

Fig. 12. Package outline SOT552-1 (TSSOP10)

14. Abbreviations

Table 14. Abbreviations

Acronym	Description
DUT	Device Under Test
ESD	ElectroStatic Discharge
HBM	Human Body Model
MIL	Military
MM	Machine Model
MIL	Military

15. Revision history

Table 15. Revision history

Document ID	Release date	Data sheet status	Change notice	Supersedes
74AXP2T08_Q100 v.2	20190327	Product data sheet	-	74AXP2T08_Q100 v.1
Modifications:	<ul style="list-style-type: none"> The format of this data sheet has been redesigned to comply with the identity guidelines of Nexperia. Legal texts have been adapted to the new company name where appropriate. 			
74AXP2T08_Q100 v.1	20161101	Product data sheet	-	-

16. Legal information

Data sheet status

Document status [1][2]	Product status [3]	Definition
Objective [short] data sheet	Development	This document contains data from the objective specification for product development.
Preliminary [short] data sheet	Qualification	This document contains data from the preliminary specification.
Product [short] data sheet	Production	This document contains the product specification.

- [1] Please consult the most recently issued document before initiating or completing a design.
- [2] The term 'short data sheet' is explained in section "Definitions".
- [3] The product status of device(s) described in this document may have changed since this document was published and may differ in case of multiple devices. The latest product status information is available on the internet at <https://www.nexperia.com>.

Definitions

Draft — The document is a draft version only. The content is still under internal review and subject to formal approval, which may result in modifications or additions. Nexperia does not give any representations or warranties as to the accuracy or completeness of information included herein and shall have no liability for the consequences of use of such information.

Short data sheet — A short data sheet is an extract from a full data sheet with the same product type number(s) and title. A short data sheet is intended for quick reference only and should not be relied upon to contain detailed and full information. For detailed and full information see the relevant full data sheet, which is available on request via the local Nexperia sales office. In case of any inconsistency or conflict with the short data sheet, the full data sheet shall prevail.

Product specification — The information and data provided in a Product data sheet shall define the specification of the product as agreed between Nexperia and its customer, unless Nexperia and customer have explicitly agreed otherwise in writing. In no event however, shall an agreement be valid in which the Nexperia product is deemed to offer functions and qualities beyond those described in the Product data sheet.

Disclaimers

Limited warranty and liability — Information in this document is believed to be accurate and reliable. However, Nexperia does not give any representations or warranties, expressed or implied, as to the accuracy or completeness of such information and shall have no liability for the consequences of use of such information. Nexperia takes no responsibility for the content in this document if provided by an information source outside of Nexperia.

In no event shall Nexperia be liable for any indirect, incidental, punitive, special or consequential damages (including - without limitation - lost profits, lost savings, business interruption, costs related to the removal or replacement of any products or rework charges) whether or not such damages are based on tort (including negligence), warranty, breach of contract or any other legal theory.

Notwithstanding any damages that customer might incur for any reason whatsoever, Nexperia's aggregate and cumulative liability towards customer for the products described herein shall be limited in accordance with the Terms and conditions of commercial sale of Nexperia.

Right to make changes — Nexperia reserves the right to make changes to information published in this document, including without limitation specifications and product descriptions, at any time and without notice. This document supersedes and replaces all information supplied prior to the publication hereof.

Suitability for use in automotive applications — This Nexperia product has been qualified for use in automotive applications. Unless otherwise agreed in writing, the product is not designed, authorized or warranted to be suitable for use in life support, life-critical or safety-critical systems or

equipment, nor in applications where failure or malfunction of an Nexperia product can reasonably be expected to result in personal injury, death or severe property or environmental damage. Nexperia and its suppliers accept no liability for inclusion and/or use of Nexperia products in such equipment or applications and therefore such inclusion and/or use is at the customer's own risk.

Quick reference data — The Quick reference data is an extract of the product data given in the Limiting values and Characteristics sections of this document, and as such is not complete, exhaustive or legally binding.

Applications — Applications that are described herein for any of these products are for illustrative purposes only. Nexperia makes no representation or warranty that such applications will be suitable for the specified use without further testing or modification.

Customers are responsible for the design and operation of their applications and products using Nexperia products, and Nexperia accepts no liability for any assistance with applications or customer product design. It is customer's sole responsibility to determine whether the Nexperia product is suitable and fit for the customer's applications and products planned, as well as for the planned application and use of customer's third party customer(s). Customers should provide appropriate design and operating safeguards to minimize the risks associated with their applications and products.

Nexperia does not accept any liability related to any default, damage, costs or problem which is based on any weakness or default in the customer's applications or products, or the application or use by customer's third party customer(s). Customer is responsible for doing all necessary testing for the customer's applications and products using Nexperia products in order to avoid a default of the applications and the products or of the application or use by customer's third party customer(s). Nexperia does not accept any liability in this respect.

Limiting values — Stress above one or more limiting values (as defined in the Absolute Maximum Ratings System of IEC 60134) will cause permanent damage to the device. Limiting values are stress ratings only and (proper) operation of the device at these or any other conditions above those given in the Recommended operating conditions section (if present) or the Characteristics sections of this document is not warranted. Constant or repeated exposure to limiting values will permanently and irreversibly affect the quality and reliability of the device.

Terms and conditions of commercial sale — Nexperia products are sold subject to the general terms and conditions of commercial sale, as published at <http://www.nexperia.com/profile/terms>, unless otherwise agreed in a valid written individual agreement. In case an individual agreement is concluded only the terms and conditions of the respective agreement shall apply. Nexperia hereby expressly objects to applying the customer's general terms and conditions with regard to the purchase of Nexperia products by customer.

No offer to sell or license — Nothing in this document may be interpreted or construed as an offer to sell products that is open for acceptance or the grant, conveyance or implication of any license under any copyrights, patents or other industrial or intellectual property rights.

Export control — This document as well as the item(s) described herein may be subject to export control regulations. Export might require a prior authorization from competent authorities.

Translations — A non-English (translated) version of a document is for reference only. The English version shall prevail in case of any discrepancy between the translated and English versions.

Trademarks

Notice: All referenced brands, product names, service names and trademarks are the property of their respective owners.

Contents

1. General description.....	1
2. Features and benefits.....	1
3. Ordering information.....	2
4. Marking.....	2
5. Functional diagram.....	2
6. Pinning information.....	3
6.1. Pinning.....	3
6.2. Pin description.....	3
7. Functional description.....	3
8. Limiting values.....	4
9. Recommended operating conditions.....	4
10. Static characteristics.....	5
11. Dynamic characteristics.....	7
12. Waveform, graphs and test circuit.....	9
13. Package outline.....	12
14. Abbreviations.....	13
15. Revision history.....	13
16. Legal information.....	14

© Nexperia B.V. 2019. All rights reserved

For more information, please visit: <http://www.nexperia.com>

For sales office addresses, please send an email to: salesaddresses@nexperia.com

Date of release: 27 March 2019