

General information

Part number	S11MAC-P05MJG0-3920
Termination	solder
Size	1
Locking principle	push
Coding	a key_medi
Cable Diameter	cable_medi_39
Cable outlet	standard

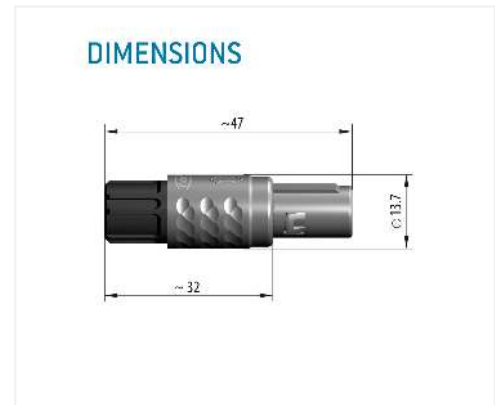
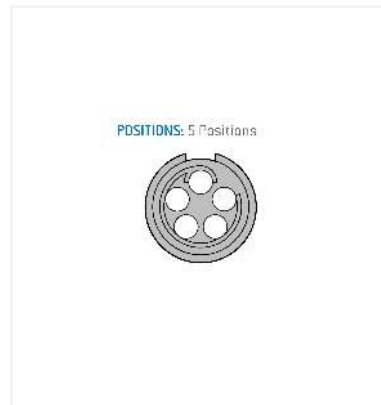

Contact insert description

Number of contacts	5
Contact type	pins
Contact diameter	09mm
Insulator material	peek
Wire cross section	22_awg
Termination	solder
Termination diameter	085mm

reverse_gender_on_request

Technical information

Max. creepage and air clearance distance	08_mm	
Nominal current single contact	075_a	iec_60512_5_2
Nominal current insert	5,625 A	vde_0298_4
Test voltage	16_kv_dc	sae_13441

safety_text

Mechanical and environmental data

Degree of protection*	ip50
Operating temperature	50_120_c
Mating cycles	2000

mated_unmated

Material and surface treatments

Housing	m_chrome
Color option	red
Contact	cu_alloy_gold

safety_text_2
ul_text
illustrative_text