

Dimensions: [mm]

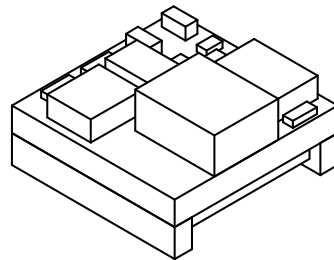
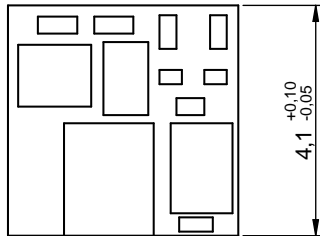
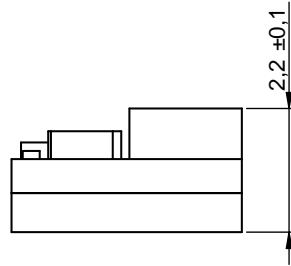
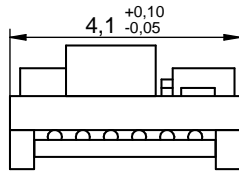
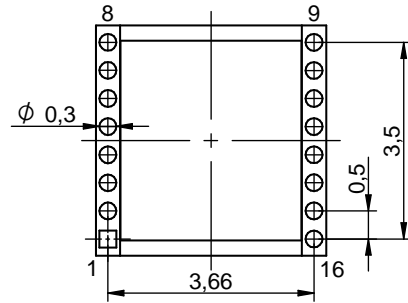

Scale - 7:1

Recommended Land Pattern: [mm]

Solder stencil thickness: max. 100 µm

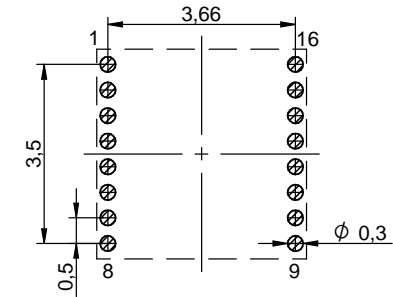

Please refer to the user manual for hardware layout recommendations

Scale - 7:1

Product Specific Pinning:

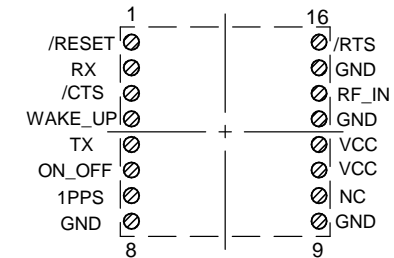

Würth Elektronik eiSos GmbH & Co. KG
EMC & Inductive Solutions
Max-Eyth-Str. 1
74638 Waldenburg
Germany
Tel. +49 (0) 79 42 945 - 0
www.we-online.com
eiSos@we-online.com

CHECKED LuSe	REVISION 003.000	DATE (YYYY-MM-DD) 2020-11-02	GENERAL TOLERANCE DIN ISO 2768-1m	PROJECTION METHOD
DESCRIPTION WIRL-POSI Elara-II GPS-GLO GNSS module T&R				ORDER CODE 2613021137000
BUSINESS UNIT eiSmart		STATUS Valid	PAGE 1/7	

General Properties:

Properties		Value	Unit
Antenna Connector Type	ANT _{Conn}	RF pad	
Microcontroller	μC	SoC	
Radio Chipset	RF-IC	SIRFstar V 5e B01	
Update rate _{max.}		5	Hz
Communication Protocol/ Standard		NMEA, OSP	
Communication interface		UART, I ² C, SPI	
Channels		52	
Memory Type		ROM-based	

Electrical Properties:

Properties		Value	Unit
Operating Supply Voltage Min.	V _{DD min.}	1.71	V
Operating Supply Voltage Max.	V _{DD max.}	1.89	V
Recommended Supply Voltage	V _{DD typ}	1.8	V
Current Consumption _{Hibernate}		53	μA

General Information:

It is recommended that the temperature of the component does not exceed +85°C under worst case conditions	
Operating Temperature	-40 up to +85 °C
Storage Conditions (in original packaging)	< 40 °C ; < 90 % RH
Moisture Sensitivity Level (MSL)	3
Light Sensitivity	Yes – for proper functionality the module shall be shielded against light

Certification:

RoHS Approval	Compliant [2011/65/EU&2015/863]
REACH Approval	Conform or declared [(EC)1907/2006]

RF-Electrical Properties:





Properties		Test conditions	Value	Unit
Rx Sensitivity (Tracking)		GPS	-164	dBm
Rx Sensitivity (Acquisition)		GPS	-148	dBm
Frequency min.	f _{min.}		1560	MHz
Frequency max.	f _{max.}		1620	MHz
Impedance	Z	Input Frequency = 1575.42 MHz	50	Ω
Return Loss	RL	Input Frequency = 1575.42 MHz	-7	dB
Current Consumption _{Acquisition}		VDD = 1.8 V, Temperature = 25°C, power level = -130dBm, GPS-GLO	52	mA
Current Consumption _{Tracking}		VDD = 1.8 V, Temperature = 25°C, power level = -130dBm, GPS-GLO	50	mA

GNSS Performances:

Properties		Test conditions	Value	Unit
GNSS Constellations Supported		GPS L1 (1575.42 MHz), GLONASS L1 (1602 MHz)	GPS, GLONASS	
Position Accuracy (GPS & GLO)		Static, VDD = 1.8 V, Temperature = 25°C, power level = -130dBm, Circular Error Probability (50%)	1.5	m
Position Accuracy (GPS)		Static, VDD = 1.8 V, Temperature = 25°C, power level = -130dBm, Circular Error Probability (50%)	2.5	m
Time To First Fix (Cold Start)		Static, VDD = 1.8 V, Temperature = 25°C, power level = -130dBm, GPS-GLO	28	s
Time To First Fix (Hot Start)		Static, VDD = 1.8 V, Temperature = 25°C, power level = -130dBm, GPS-GLO	1	s



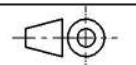

Product Specific Pinning:

Pin	Pad	Description	I/O
/RESET	1	Reset	Input
RX	2	Receive	Input/Output

  	CHECKED LuSe	REVISION 003.000	DATE (YYYY-MM-DD) 2020-11-02	GENERAL TOLERANCE DIN ISO 2768-1m	PROJECTION METHOD 
	WÜRTH ELEKTRONIK eiSos GmbH & Co. KG EMC & Inductive Solutions Max-Eyth-Str. 1 74638 Waldenburg Germany Tel. +49 (0) 79 42 945 - 0 www.we-online.com eiSos@we-online.com				
	DESCRIPTION WIRL-POSI Elara-II GPS-GLO GNSS module T&R			ORDER CODE 2613021137000	
	BUSINESS UNIT eiSmart	STATUS Valid	PAGE 2/7		

Product Specific Pinning:

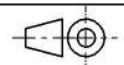
Pin	Pad	Description	I/O
/CTS	3	Clear to send signal	Input/Output
WAKE_UP	4	Operation mode status	Output
TX	5	Transmit	Input/Output
ON_OFF	6	Power State Control	Input
1PPS	7	UTC Time Mark	Output
GND	8	Negative supply voltage	Supply
GND	9	Negative supply voltage	Supply
NC	10	Not connected	--
VCC	11	Positive supply voltage (VDD)	Supply
VCC	12	Positive supply voltage (VDD)	Supply
GND	13	Negative supply voltage	Supply
RF_IN	14	RF Signal Input	Input
GND	15	Negative supply voltage	Supply
/RTS	16	Request to send signal	Input/Output

  	CHECKED LuSe	REVISION 003.000	DATE (YYYY-MM-DD) 2020-11-02	GENERAL TOLERANCE DIN ISO 2768-1m	PROJECTION METHOD 	
	DESCRIPTION WIRL-POSI Elara-II GPS-GLO GNSS module T&R				ORDER CODE 2613021137000	
	Würth Elektronik eiSos GmbH & Co. KG EMC & Inductive Solutions Max-Eyth-Str. 1 74638 Waldenburg Germany Tel. +49 (0) 79 42 945 - 0 www.we-online.com eiSos@we-online.com			BUSINESS UNIT eiSmart	STATUS Valid	PAGE 3/7
	This electronic component has been designed and developed for usage in general electronic equipment only. This product is not authorized for use in equipment where a higher safety standard and reliability standard is especially required or where a failure of the product is reasonably expected to cause severe personal injury or death, unless the parties have executed an agreement specifically governing such use. Moreover Würth Elektronik eiSos GmbH & Co KG products are neither designed nor intended for use in areas such as military, aerospace, aviation, nuclear control, submarine, transportation (automotive control, train control, ship control), transportation signal, disaster prevention, medical, public information network etc.. Würth Elektronik eiSos GmbH & Co KG must be informed about the intent of such usage before the design-in stage. In addition, sufficient reliability evaluation checks for safety must be performed on every electronic component which is used in electrical circuits that require high safety and reliability functions or performance.					

Packaging Specification - Tape and Reel: [mm]

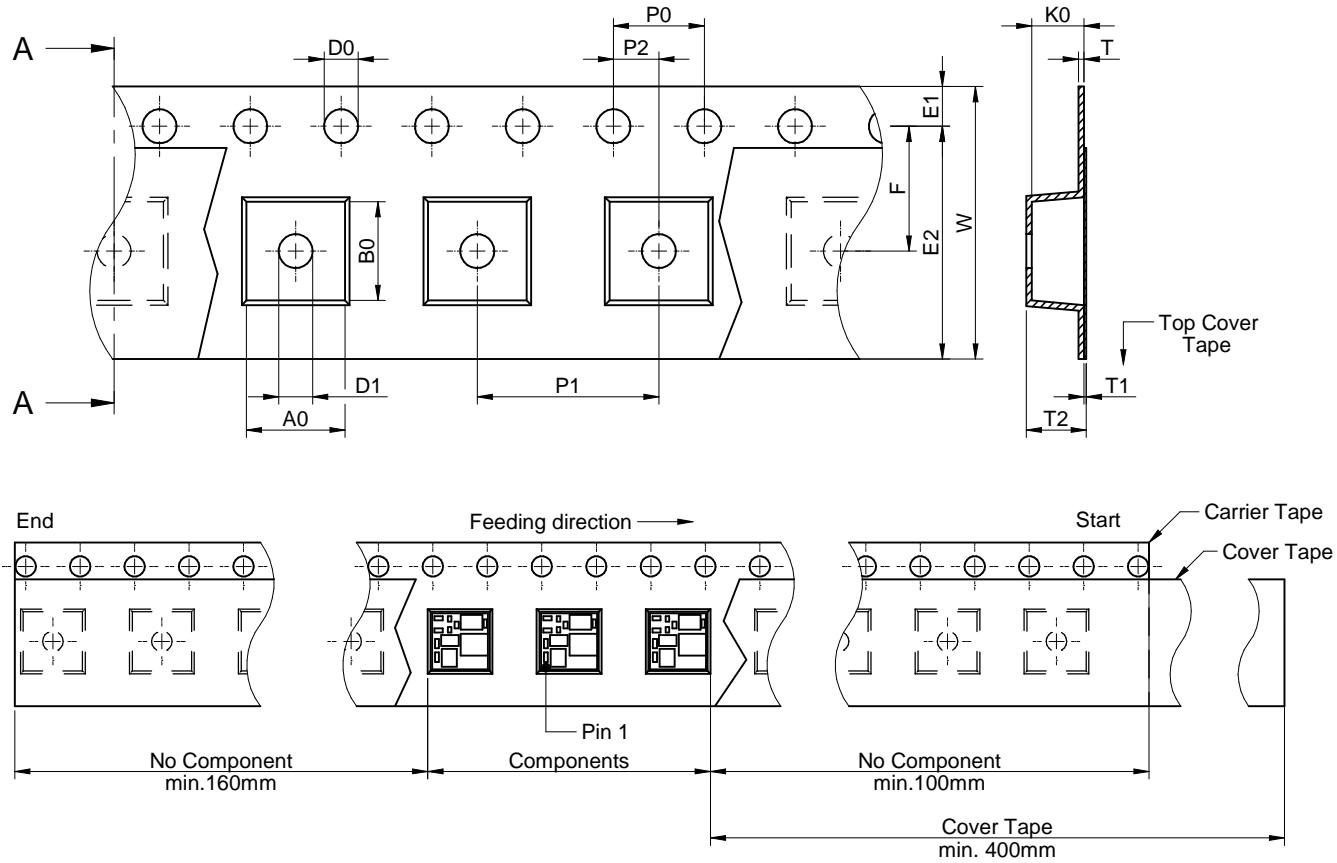

Tape Type	A0 (mm)	B0 (mm)	W (mm)	T (mm)	T1 (mm)	T2 (mm)	K0 (mm)	P0 (mm)	P1 (mm)	P2 (mm)	D0 (mm)	D1 (mm)	E1 (mm)	E2 (mm)	F (mm)	Material	Qty. (pcs.)
	±0,1	±0,1	±0,3	±0,05	ref.	typ.	±0,1	±0,1	±	±0,05	+0,1/-0,0	min.	±0,1	min.	±0,05		
2a	4,35	4,35	12,00	0,35	0,10	2,55	2,30	4,00	8,00	2,00	1,50	1,50	1,75	10,25	5,50	Polystyrene	500

Packaging Specification - Tape and Reel: [mm]

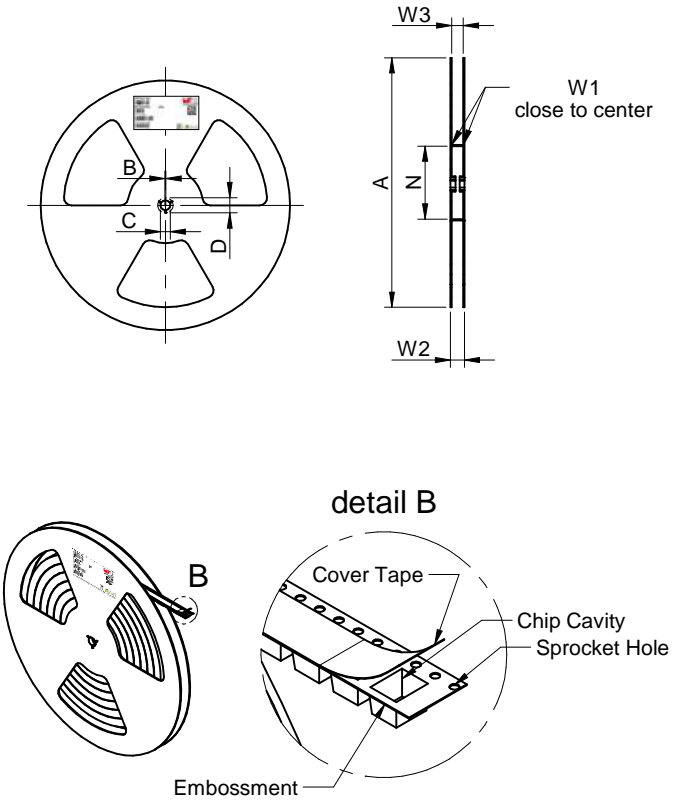

A (mm)	B (mm)	C (mm)	D (mm)	N (mm)	W1 (mm)	W2 (mm)	W3 (mm)	W3 (mm)	Material
± 2,0	min.	min.	min.	min.	+ 2,0	max.	min.	max.	
330,00	1,50	12,80	20,20	60,00	12,40	18,40	11,90	15,40	Polystyrene



Würth Elektronik eiSos GmbH & Co. KG
EMC & Inductive Solutions
Max-Eyth-Str. 1
74638 Waldenburg
Germany
Tel. +49 (0) 79 42 945 - 0
www.we-online.com
eiSos@we-online.com

CHECKED	REVISION	DATE (YYYY-MM-DD)	GENERAL TOLERANCE	PROJECTION METHOD
LuSe	003.000	2020-11-02	DIN ISO 2768-1m	
DESCRIPTION				
WIRL-POSI Elara-II GPS-GLO GNSS module T&R				
ORDER CODE				
2613021137000				
BUSINESS UNIT		STATUS		PAGE
eiSmart		Valid		4/7

Classification Reflow Profile for SMT components:

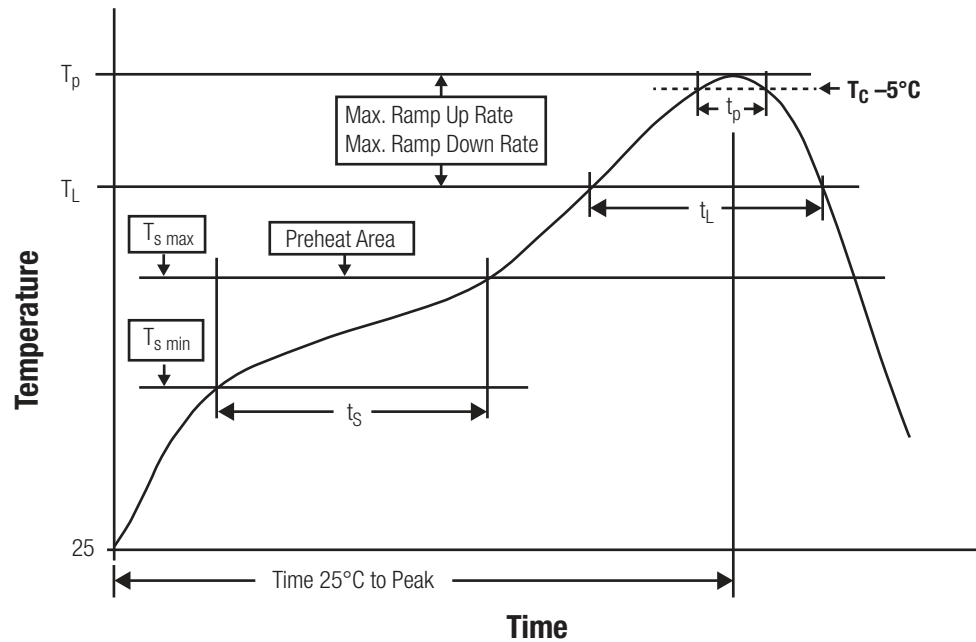

Classification Reflow Soldering Profile:

Profile Feature		Value
Preheat Temperature Min	$T_{s\ min}$	150 °C
Preheat Temperature Max	$T_{s\ max}$	200 °C
Preheat Time t_s from $T_{s\ min}$ to $T_{s\ max}$	t_s	60 - 120 seconds
Ramp-up Rate (T_L to T_p)		3 °C/ second max.
Liquidous Temperature	T_L	217 °C
Time t_L maintained above T_L	t_L	60 - 150 seconds
Peak package body temperature	T_p	245°C max.
Time within 5°C of actual peak temperature	t_p	20 - 30 seconds
Ramp-down Rate (T_p to T_L)		6 °C/ second max.
Time 25°C to peak temperature		8 minutes max.

refer to IPC/ JEDEC J-STD-020E

	CHECKED LuSe	REVISION 003.000	DATE (YYYY-MM-DD) 2020-11-02	GENERAL TOLERANCE DIN ISO 2768-1m	PROJECTION METHOD
	DESCRIPTION WIRL-POSI Elara-II GPS-GLO GNSS module T&R				ORDER CODE 2613021137000
	Würth Elektronik eiSos GmbH & Co. KG EMC & Inductive Solutions Max-Eyth-Str. 1 74638 Waldenburg Germany Tel. +49 (0) 79 42 945 - 0 www.we-online.com eiSos@we-online.com			BUSINESS UNIT eiSmart	STATUS Valid
					PAGE 5/7

Cautions and Warnings:

The following conditions apply to all goods within the product series of wireless connectivity of Würth Elektronik eiSos GmbH & Co. KG:

General:

- This electronic component is designed and developed with the intention for use in general electronic equipment.
- Würth Elektronik must be asked for written approval (following the PPAP procedure) before incorporating the components into any equipment in fields such as military, aerospace, aviation, nuclear control, submarine, transportation (automotive control, train control, ship control), transportation signal, disaster prevention, medical, public information network, etc. where higher safety and reliability are especially required and/or if there is the possibility of direct damage or human injury.
- Electronic components that will be used in safety-critical or high-reliability applications, should be pre-evaluated by the customer.
- The component is designed and manufactured to be used within the datasheet specified values. If the usage and operation conditions specified in the datasheet are not met, the wire insulation may be damaged or dissolved.
- Do not drop or impact the components, the component may be damaged.
- Würth Elektronik products are qualified according to international standards, which are listed in each product reliability report. Würth Elektronik does not guarantee any customer qualified product characteristics beyond Würth Elektronik's specifications, for its validity and sustainability over time.
- The responsibility for the applicability of the customer specific products and use in a particular customer design is always within the authority of the customer. All technical specifications for standard products also apply to customer specific products.

Product specific:

Soldering:

- The solder profile must comply with the technical product specifications. All other profiles will void the warranty.
- All other soldering methods are at the customer's own risk.

Cleaning and Washing:

- Washing agents used during the production to clean the customer application might damage or change the characteristics of the component. Washing agents may have a negative effect on the long-term functionality of the product.
- Using a brush during the cleaning process could break the module. Therefore, we do not recommend using a brush during the PCB cleaning process.

Potting and Coating:

- If the product is potted in the customer application, the potting material might shrink or expand during and after hardening. Shrinking could lead to an incomplete seal, allowing contaminants into the component. Expansion could damage components. We recommend a manual inspection after potting to avoid these effects.

- Conformal coating may affect the product performance.

Storage Conditions:



- A storage of Würth Elektronik products for longer than 12 months is not recommended. Within other effects, the terminals may suffer degradation, resulting in bad solderability. Therefore, all products shall be used within the period of 12 months based on the day of shipment.
- Do not expose the components to direct sunlight.
- The storage conditions in the original packaging are defined according to DIN EN 61760-2.
- If there is a moisture sensitive component, the storage condition in the original packaging is defined according to IPC/JEDEC-J-STD-033. It is also recommended to return the component to the original moisture proof bag and reseal the moisture proof bag again.
- ESD prevention methods need to be followed for manual handling and processing by machinery.
- The storage conditions stated in the original packaging apply to the storage time and not to the transportation time of the components.

Handling:

- Violation of the technical product specifications such as exceeding the nominal rated current, will void the warranty.
- Violation of the technical product specifications such as but not limited to exceeding the absolute maximum ratings will void the conformance to regulatory requirements.
- The edge castellation is designed and made for prototyping, i.e. hand soldering purposes only.
- Non-antenna modules must be equipped with a proper antenna having specific characteristics.
- The applicable country regulations and specific environmental regulations must be observed.
- Do not disassemble the product. Evidence of tampering will void the warranty.
- The temperature rise of the component must be taken into consideration. The operating temperature is comprised of ambient temperature and temperature rise of the component. The operating temperature of the component shall not exceed the maximum temperature specified.

These cautions and warnings comply with the state of the scientific and technical knowledge and are believed to be accurate and reliable. However, no responsibility is assumed for inaccuracies or incompleteness.

All topics are described in a more detailed manner in the manual for each product.

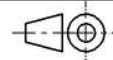
 	CHECKED LuSe	REVISION 003.000	DATE (YYYY-MM-DD) 2020-11-02	GENERAL TOLERANCE DIN ISO 2768-1m	PROJECTION METHOD 
	DESCRIPTION WIRL-POSI Elara-II GPS-GLO GNSS module T&R				ORDER CODE 2613021137000
	BUSINESS UNIT eiSmart		STATUS Valid	PAGE 6/7	
Würth Elektronik eiSos GmbH & Co. KG EMC & Inductive Solutions Max-Eyth-Str. 1 74638 Waldenburg Germany Tel. +49 (0) 79 42 945 - 0 www.we-online.com eiSos@we-online.com					

Important Notes

The following conditions apply to all goods within the product range of Würth Elektronik eiSos GmbH & Co. KG:

1. General Customer Responsibility

Some goods within the product range of Würth Elektronik eiSos GmbH & Co. KG contain statements regarding general suitability for certain application areas. These statements about suitability are based on our knowledge and experience of typical requirements concerning the areas, serve as general guidance and cannot be estimated as binding statements about the suitability for a customer application. The responsibility for the applicability and use in a particular customer design is always solely within the authority of the customer. Due to this fact it is up to the customer to evaluate, where appropriate to investigate and decide whether the device with the specific product characteristics described in the product specification is valid and suitable for the respective customer application or not.

2. Customer Responsibility related to Specific, in particular Safety-Relevant Applications

It has to be clearly pointed out that the possibility of a malfunction of electronic components or failure before the end of the usual lifetime cannot be completely eliminated in the current state of the art, even if the products are operated within the range of the specifications. In certain customer applications requiring a very high level of safety and especially in customer applications in which the malfunction or failure of an electronic component could endanger human life or health it must be ensured by most advanced technological aid of suitable design of the customer application that no injury or damage is caused to third parties in the event of malfunction or failure of an electronic component. Therefore, customer is cautioned to verify that data sheets are current before placing orders. The current data sheets can be downloaded at www.we-online.com.

3. Best Care and Attention

Any product-specific notes, cautions and warnings must be strictly observed. Any disregard will result in the loss of warranty.

4. Customer Support for Product Specifications

Some products within the product range may contain substances which are subject to restrictions in certain jurisdictions in order to serve specific technical requirements. Necessary information is available on request. In this case the field sales engineer or the internal sales person in charge should be contacted who will be happy to support in this matter.

5. Product R&D

Due to constant product improvement product specifications may change from time to time. As a standard reporting procedure of the Product Change Notification (PCN) according to the JEDEC-Standard inform about minor and major changes. In case of further queries regarding the PCN, the field sales engineer or the internal sales person in charge should be contacted. The basic responsibility of the customer as per Section 1 and 2 remains unaffected.

6. Product Life Cycle



Due to technical progress and economical evaluation we also reserve the right to discontinue production and delivery of products. As a standard reporting procedure of the Product Termination Notification (PTN) according to the JEDEC-Standard we will inform at an early stage about inevitable product discontinuance. According to this we cannot guarantee that all products within our product range will always be available. Therefore it needs to be verified with the field sales engineer or the internal sales person in charge about the current product availability expectancy before or when the product for application design-in disposal is considered. The approach named above does not apply in the case of individual agreements deviating from the foregoing for customer-specific products.

7. Property Rights

All the rights for contractual products produced by Würth Elektronik eiSos GmbH & Co. KG on the basis of ideas, development contracts as well as models or templates that are subject to copyright, patent or commercial protection supplied to the customer will remain with Würth Elektronik eiSos GmbH & Co. KG. Würth Elektronik eiSos GmbH & Co. KG does not warrant or represent that any license, either expressed or implied, is granted under any patent right, copyright, mask work right, or other intellectual property right relating to any combination, application, or process in which Würth Elektronik eiSos GmbH & Co. KG components or services are used.

8. General Terms and Conditions

Unless otherwise agreed in individual contracts, all orders are subject to the current version of the "General Terms and Conditions of Würth Elektronik eiSos Group", last version available at www.we-online.com.

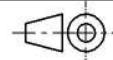
 	CHECKED LuSe	REVISION 003.000	DATE (YYYY-MM-DD) 2020-11-02	GENERAL TOLERANCE DIN ISO 2768-1m	PROJECTION METHOD 
	DESCRIPTION WIRL-POSI Elara-II GPS-GLO GNSS module T&R				ORDER CODE 2613021137000
	Würth Elektronik eiSos GmbH & Co. KG EMC & Inductive Solutions Max-Eyth-Str. 1 74638 Waldenburg Germany Tel. +49 (0) 79 42 945 - 0 www.we-online.com eiSos@we-online.com			BUSINESS UNIT eiSmart	STATUS Valid