

VC-AR2-EMV

Order No.: 1853227

<http://eshop.phoenixcontact.de/phoenix/treeViewClick.do?UID=1853227>EMC shield adapter, for EMC plug connector, type 2, number of insert
modules 3

Commercial data	
GTIN (EAN)	 4 017918 127268
sales group	D200
Pack	5 pcs.
Customs tariff	85389099
Catalog page information	Page 360 (PC-2009)

Product notes

WEEE/RoHS-compliant since:
11/17/2006

<http://www.download.phoenixcontact.com>
Please note that the data given here has been taken from the online catalog. For comprehensive information and data, please refer to the user documentation. The General Terms and Conditions of Use apply to Internet downloads.

Technical data

General data	
Note	For painted surfaces with conductive panel cutout
Design	VC2

Material data

Contact material	CuZn
Contact surface material	Nickel-plated

Certificates / Approvals

Certification CUL, GOST, UL

Diagrams/Drawings

Dimensioned drawing

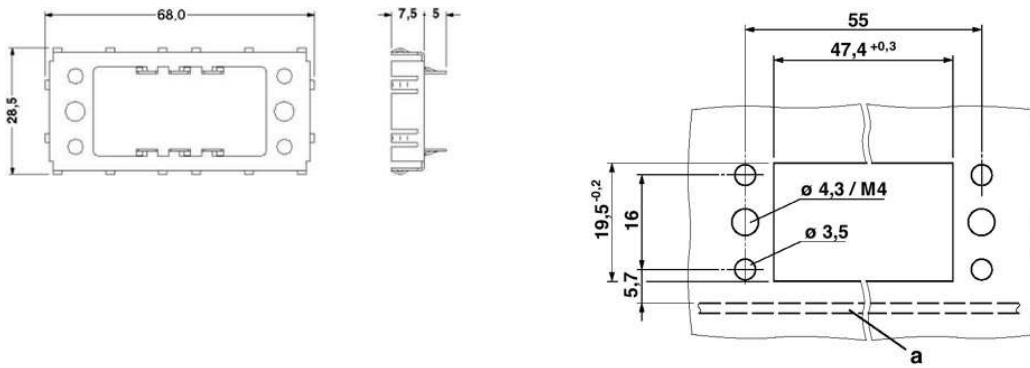

a - PCB

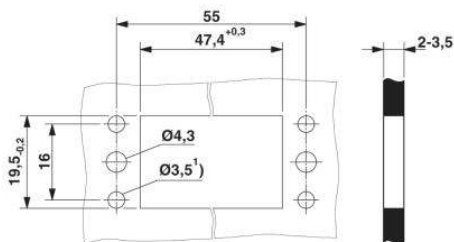

Address

PHOENIX CONTACT Deutschland GmbH
Flachmarktstr. 8
32825 Blomberg, Germany
Phone +49 5235 3 12000
Fax +49 5235 3 41200
<http://www.phoenixcontact.de>



© 2011 Phoenix Contact
Technical modifications reserved;