

Product Summary (Per Leg, @ $T_A = +25^\circ\text{C}$)

V_{RRM} (V)	I_o (A)	V_F (V)	I_R (μA)
400	10	1.3	10

Features and Benefits

- Super-Fast Switching Capability
- Glass Passivated Die Construction
- Rating to 400V Peak Reverse Voltage
- High Surge Capacity
- Low Forward Voltage Drop
- Low Reverse Leakage Current
- **Lead-Free Finish; RoHS Compliant (Notes 1 & 2)**
- **Halogen and Antimony Free. "Green" Device (Note 3)**
- **For automotive applications requiring specific change control (i.e. parts qualified to AEC-Q100/101/104/200, PPAP capable, and manufactured in IATF 16949 certified facilities), please [contact us](mailto:contact@diodes.com) or your local Diodes representative.**
<https://www.diodes.com/quality/product-definitions/>

Applications

- Switched mode power supplies
- High frequency DC to DC converters

Mechanical Data

- Package: ITO220AB
- Package Material: Molded Plastic, "Green" Molding Compound. UL Flammability Classification Rating 94V-0
- Terminals: Finish – Matte Tin Plated Leads Solderable per MIL-STD-202, Method 208 @3
- Polarity: See Diagram
- Weight: 1.558 grams (Approximate)

ITO220AB (Type WX2)

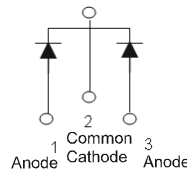
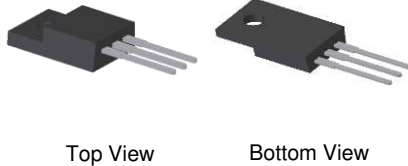

Package Pin Out Configuration

Ordering Information (Note 4)

Part Number	Package	Packing	
		Qty.	Carrier
STPS2040	ITO220AB (Type WX2)	50 Pieces	Tube

- Notes:
1. EU Directive 2002/95/EC (RoHS), 2011/65/EU (RoHS 2) & 2015/863/EU (RoHS 3) compliant. All applicable RoHS exemptions applied.
 2. See <https://www.diodes.com/quality/lead-free/> for more information about Diodes Incorporated's definitions of Halogen- and Antimony-free, "Green" and Lead-free.
 3. Halogen- and Antimony-free "Green" products are defined as those which contain <900ppm bromine, <900ppm chlorine (<1500ppm total Br + Cl) and <1000ppm antimony compounds.
 4. For packaging details, go to our website at <https://www.diodes.com/design/support/packaging/diodes-packaging/>.

Marking Information

ITO220AB (Type WX2)

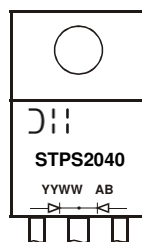

STPS2040 = Product Type Marking Code
 DII = Manufacturer's Marking
 YYWW = Date Code Marking
 YY = Last Two Digits of Year (ex: 22 for 2022)
 WW = Week Code (01 to 53)
 AB = Foundry and Assembly Code

Maximum Ratings (@ $T_A = +25^\circ\text{C}$, unless otherwise specified.)

Characteristic	Symbol	Value	Unit
Peak Repetitive Reverse Voltage DC Blocking Voltage	V_{RRM} V_R	400	V
Average Rectified Output Current, @ $T_C = +75^\circ\text{C}$ (Per Leg) (Total)	I_O	10 20	A
Non-Repetitive Peak Forward Surge Current 8.3ms Single Half Sine-Wave Superimposed on Rated Load	I_{FSM}	125	A

Thermal Characteristics

Characteristic	Symbol	Value	Unit
Typical Thermal Resistance Junction to Case (Notes 5 & 6)	$R_{\theta JC}$	3	$^\circ\text{C/W}$
Typical Thermal Resistance Junction to Lead (Notes 5 & 6)	$R_{\theta JL}$	3	$^\circ\text{C/W}$
Operating and Storage Temperature Range	T_J, T_{STG}	-55 to +150	$^\circ\text{C}$

Electrical Characteristics (@ $T_A = +25^\circ\text{C}$, unless otherwise specified.)

Characteristic	Symbol	Min	Typ	Max	Unit	Test Condition
Reverse Breakdown Voltage (Note 7)	$V_{(BR)R}$	400	—	—	V	$I_R = 10\mu\text{A}$
Forward Voltage (Note 8)	V_F	—	—	1.30	V	$I_F = 10\text{A}, T_J = +25^\circ\text{C}$
		—	0.90	1.20	V	$I_F = 10\text{A}, T_J = +125^\circ\text{C}$
Reverse Leakage Current (Note 7)	I_R	—	—	10	μA	$V_R = 400\text{V}, T_J = +25^\circ\text{C}$
		—	2.45	500	μA	$V_R = 400\text{V}, T_J = +100^\circ\text{C}$
Typical Total Capacitance	C_T	—	80	—	pF	$V_R = 4\text{V}, f = 1.0\text{MHz}$
Reverse Recovery Time	t_{RR}	—	—	35	ns	$I_F = 0.5\text{A}, I_R = 1.0\text{A}, I_{RR} = 0.25\text{A}$

- Notes:
5. Thermal resistance test performed in accordance with JESD-51.
 6. The unit mounted on aluminum plate 45mm x 12mm x 1.6mm and copper heatsink 250mm x 250mm x 10mm in free air condition.
 7. Short duration pulse test used to minimize self-heating effect.
 8. 300 μs pulse width, 2% duty cycle.

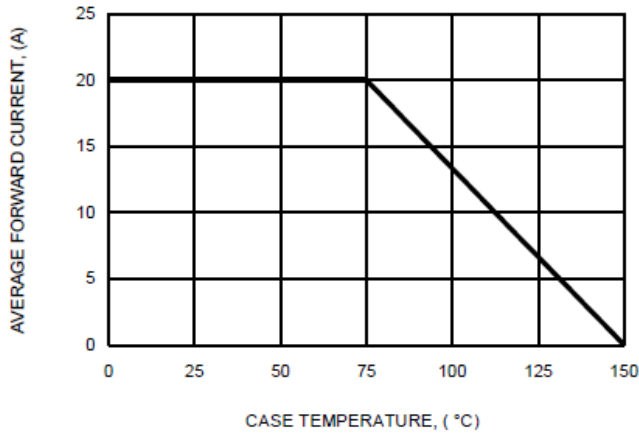

Fig. 1 FORWARD CURRENT DERATING CURVE

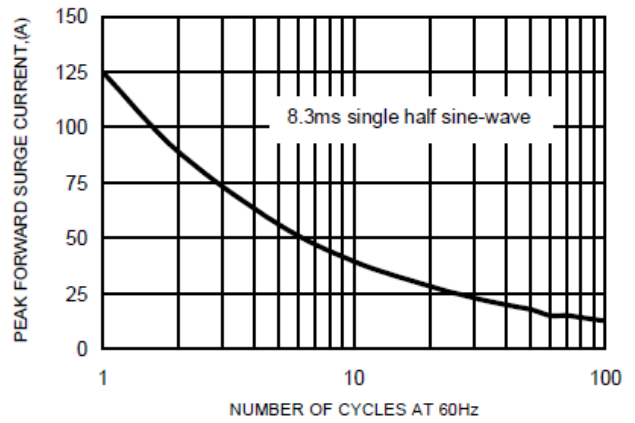

Fig. 2 MAXIMUM NON-REPETITIVE SURGE CURRENT

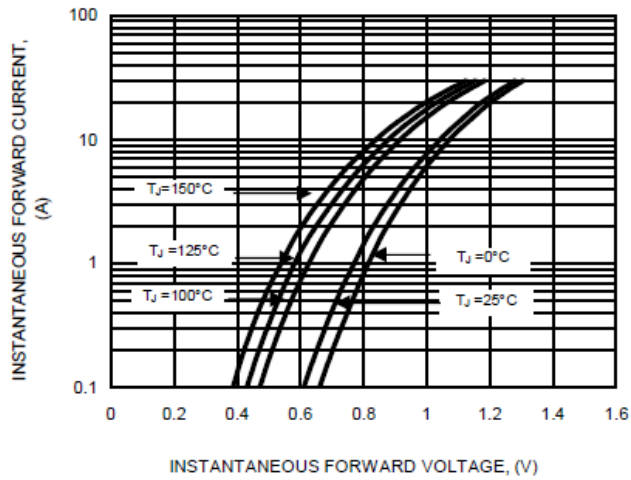

Fig. 3 TYPICAL FORWARD CHARACTERISTICS

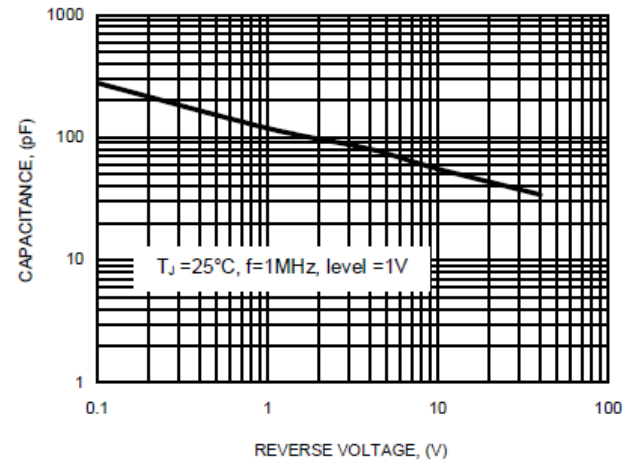

Fig. 4 TYPICAL TOTAL CAPACITANCE

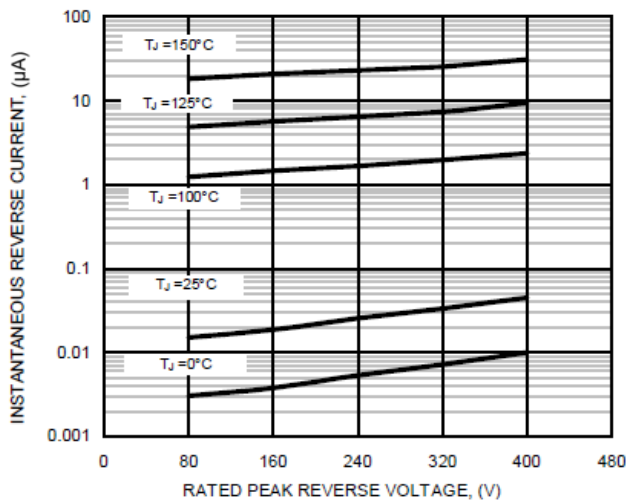
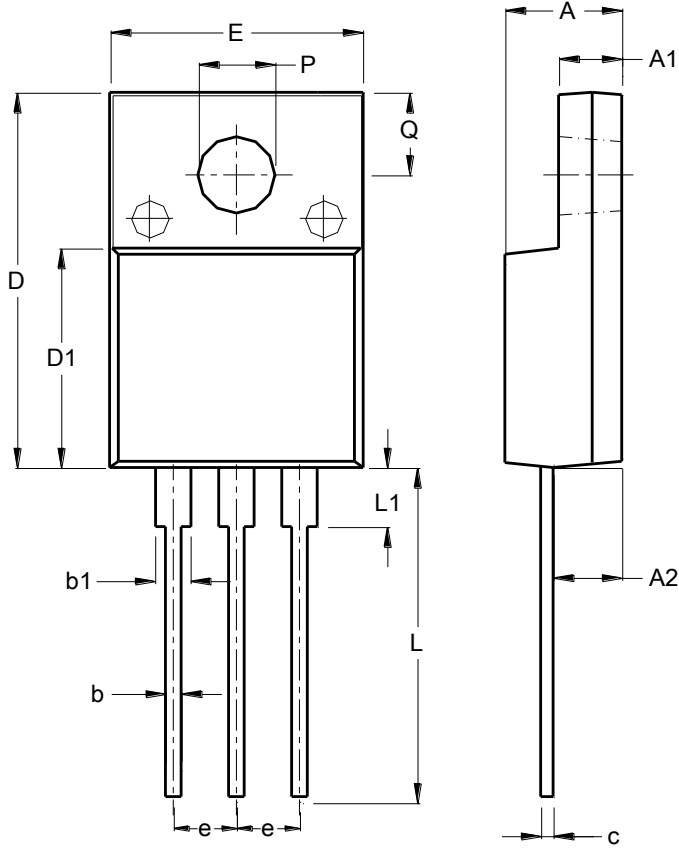

Fig. 5 TYPICAL REVERSE CHARACTERISTICS

Package Outline Dimensions

Please see <http://www.diodes.com/package-outlines.html> for the latest version.

ITO220AB (Type WX2)



ITO220AB (Type WX2)		
Dim	Min	Max
A	4.46	4.87
A1	2.48	2.80
A2	2.50	2.80
b	0.50	0.80
b1	1.15	1.70
c	0.45	0.70
D	14.95	15.95
D1	8.50	8.80
E	10.00	10.40
e	2.40	2.70
L	13.00	13.70
L1	2.10	2.50
Q	2.76	3.36
P	3.00	3.30
All Dimensions in mm		

IMPORTANT NOTICE

1. DIODES INCORPORATED (Diodes) AND ITS SUBSIDIARIES MAKE NO WARRANTY OF ANY KIND, EXPRESS OR IMPLIED, WITH REGARDS TO ANY INFORMATION CONTAINED IN THIS DOCUMENT, INCLUDING, BUT NOT LIMITED TO, THE IMPLIED WARRANTIES OF MERCHANTABILITY, FITNESS FOR A PARTICULAR PURPOSE OR NON-INFRINGEMENT OF THIRD PARTY INTELLECTUAL PROPERTY RIGHTS (AND THEIR EQUIVALENTS UNDER THE LAWS OF ANY JURISDICTION).
2. The Information contained herein is for informational purpose only and is provided only to illustrate the operation of Diodes' products described herein and application examples. Diodes does not assume any liability arising out of the application or use of this document or any product described herein. This document is intended for skilled and technically trained engineering customers and users who design with Diodes' products. Diodes' products may be used to facilitate safety-related applications; however, in all instances customers and users are responsible for (a) selecting the appropriate Diodes products for their applications, (b) evaluating the suitability of Diodes' products for their intended applications, (c) ensuring their applications, which incorporate Diodes' products, comply the applicable legal and regulatory requirements as well as safety and functional-safety related standards, and (d) ensuring they design with appropriate safeguards (including testing, validation, quality control techniques, redundancy, malfunction prevention, and appropriate treatment for aging degradation) to minimize the risks associated with their applications.
3. Diodes assumes no liability for any application-related information, support, assistance or feedback that may be provided by Diodes from time to time. Any customer or user of this document or products described herein will assume all risks and liabilities associated with such use, and will hold Diodes and all companies whose products are represented herein or on Diodes' websites, harmless against all damages and liabilities.
4. Products described herein may be covered by one or more United States, international or foreign patents and pending patent applications. Product names and markings noted herein may also be covered by one or more United States, international or foreign trademarks and trademark applications. Diodes does not convey any license under any of its intellectual property rights or the rights of any third parties (including third parties whose products and services may be described in this document or on Diodes' website) under this document.
5. Diodes' products are provided subject to Diodes' Standard Terms and Conditions of Sale (<https://www.diodes.com/about/company/terms-and-conditions/terms-and-conditions-of-sales/>) or other applicable terms. This document does not alter or expand the applicable warranties provided by Diodes. Diodes does not warrant or accept any liability whatsoever in respect of any products purchased through unauthorized sales channel.
6. Diodes' products and technology may not be used for or incorporated into any products or systems whose manufacture, use or sale is prohibited under any applicable laws and regulations. Should customers or users use Diodes' products in contravention of any applicable laws or regulations, or for any unintended or unauthorized application, customers and users will (a) be solely responsible for any damages, losses or penalties arising in connection therewith or as a result thereof, and (b) indemnify and hold Diodes and its representatives and agents harmless against any and all claims, damages, expenses, and attorney fees arising out of, directly or indirectly, any claim relating to any noncompliance with the applicable laws and regulations, as well as any unintended or unauthorized application.
7. While efforts have been made to ensure the information contained in this document is accurate, complete and current, it may contain technical inaccuracies, omissions and typographical errors. Diodes does not warrant that information contained in this document is error-free and Diodes is under no obligation to update or otherwise correct this information. Notwithstanding the foregoing, Diodes reserves the right to make modifications, enhancements, improvements, corrections or other changes without further notice to this document and any product described herein. This document is written in English but may be translated into multiple languages for reference. Only the English version of this document is the final and determinative format released by Diodes.
8. Any unauthorized copying, modification, distribution, transmission, display or other use of this document (or any portion hereof) is prohibited. Diodes assumes no responsibility for any losses incurred by the customers or users or any third parties arising from any such unauthorized use.
9. This Notice may be periodically updated with the most recent version available at <https://www.diodes.com/about/company/terms-and-conditions/important-notice>

DIODES is a trademark of Diodes Incorporated in the United States and other countries.
The Diodes logo is a registered trademark of Diodes Incorporated in the United States and other countries.
© 2022 Diodes Incorporated. All Rights Reserved.

www.diodes.com