

# FEMALE PLUG M12 90° ANGLED TO MALE PLUG M12 90° ANGLED

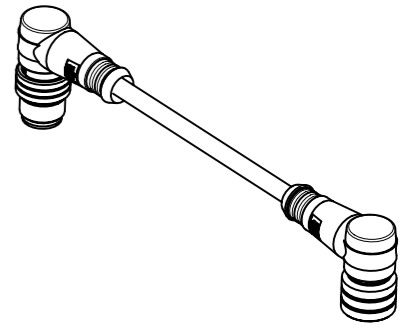
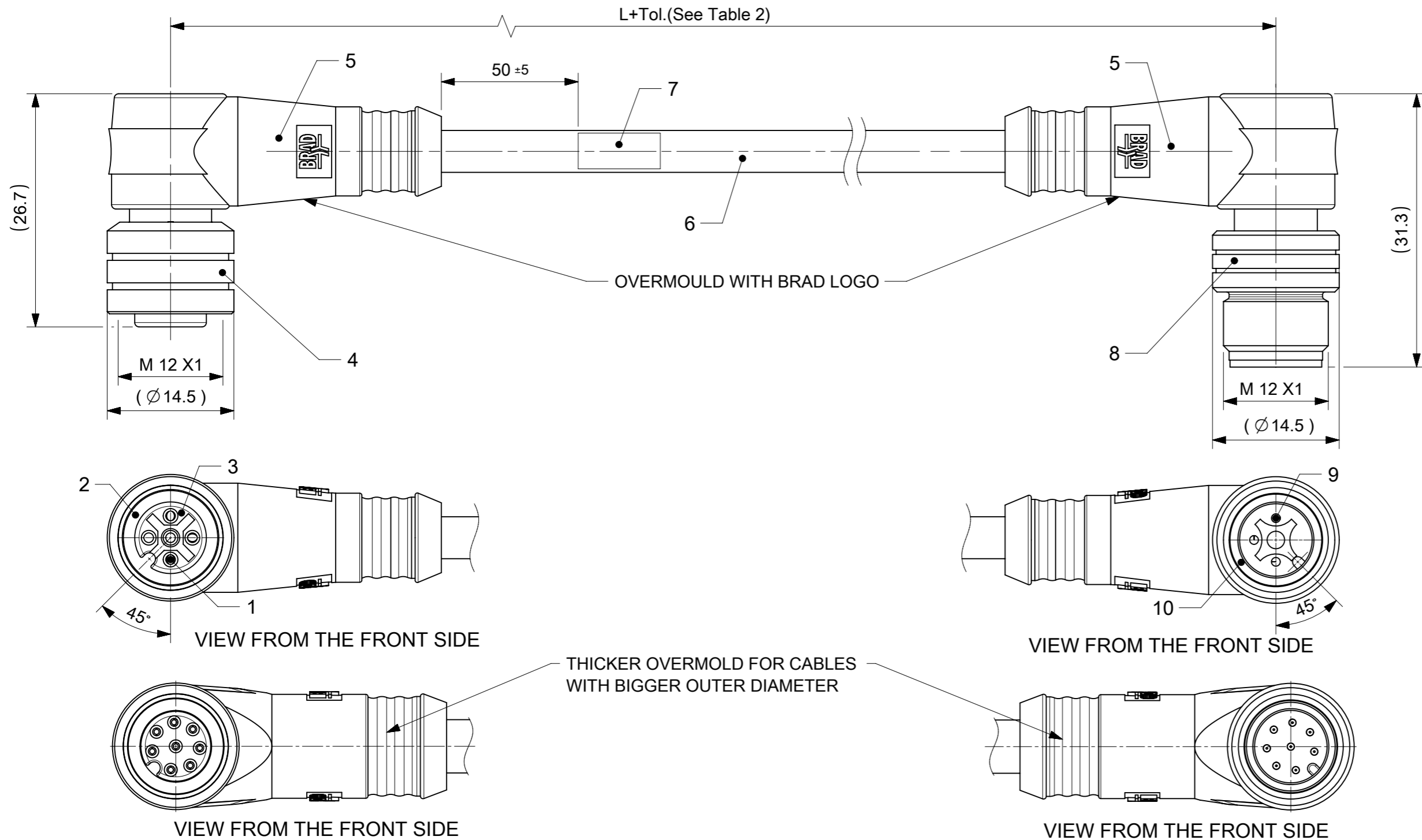

SCALE 1:2

## BILL OF MATERIALS

ITEM	QTY.	DESCRIPTION	MATERIAL	FINISH/COLOR
10	1	INSERT MALE	PUR	BLACK
9	3	CONTACT M12 MALE	BRASS	SELECTIVE GOLD OVER NICKEL
8	1	COUPLING NUT MALE	BRASS	NICKEL
7	1	LABEL	VINYL	YELLOW
6	-	CABLE	SEE MATRIX/ CABLE SPECIFICATION	SEE CABLE SPECIFICATION
5	1	OVERMOULD	TPU	SEE MATRIX
4	1	COUPLING NUT FEMALE	BRASS	NICKEL
3	1	INSERT FEMALE	PUR	BLACK
2	1	O-RING	FPM	RED
1	3	CONTACT M12 FEMALE	BRASS	SELECTIVE GOLD OVER NICKEL
ITEM	QTY.	DESCRIPTION	MATERIAL	FINISH/COLOR

**NOTES:**  
 CONTACT CURRENT RATING: 3-5 POLES 4A  
 8 POLES 2A  
 VOLTAGE RATING: 3-4 POLES 250V  
 5 POLES 60V DC  
 8 POLES 30V  
 PROTECTION CLASS: IP 67  
 TEMPERATURE: -25°C / +85°C

FUNCTIONAL SYMBOLS ∇A = 0 ∇E = 0 ∇F = 0	THIS DRAWING CONTAINS INFORMATION THAT IS PROPRIETARY TO MOLEX ELECTRONIC TECHNOLOGIES, LLC AND SHOULD NOT BE USED WITHOUT WRITTEN PERMISSION	SCALE 2:1	CURRENT REV DESC: ADDED NEW PNS			
	DIMENSION UNITS mm	GENERAL TOLERANCES (UNLESS SPECIFIED)	EC NO: 695290			
DIVISIONAL SYMBOLS	ANGULAR TOL ± 1.0°	4 PLACES ±	DRWN: MDHARMANTI	2021/11/26	<b>molex</b>	
	3 PLACES ±	2 PLACES ± 0.05	CHK'D: RSILLER	2022/02/11		CSE M12 XP AC FE RA MA RA XM
	2 PLACES ± 0.3	1 PLACE ± 0.5	APPR: RSILLER	2022/02/11	PRODUCT CUSTOMER DRAWING	
	0 PLACES ± 0.5	DRAFT WHERE APPLICABLE MUST REMAIN WITHIN DIMENSIONS	INITIAL REVISION:	DRWN: DSOPPIN	2018/09/27	DOCUMENT NUMBER 1200070187
	THIRD ANGLE PROJECTION	DRAWING A3-SIZE	SERIES 120007	APPR: RSILLER	2018/10/22	DOC TYPE PSD
		MATERIAL NUMBER SEE TABLE	CUSTOMER GENERAL MARKET	DOC PART 000	REVISION A3	
				SHEET NUMBER 1 OF 3		

ENGINEERING NO. - NUMERICAL CODE (Available parts see PART LIST table. Others on request).

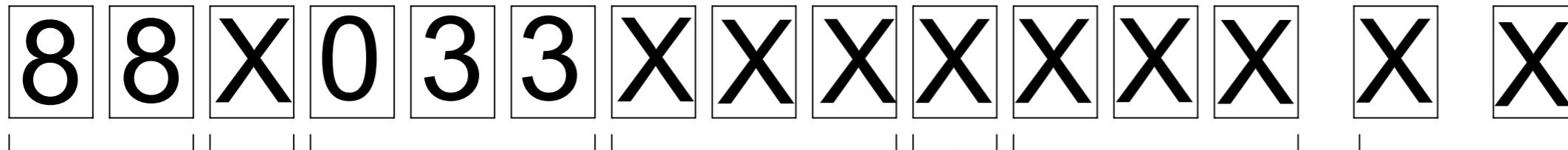

88 = M12x1  
Double ended

Poles:  
3 = 3 Poles  
4 = 4 Poles  
5 = 5 Poles

Heads style:  
033 = Plugs FE 90° & Male 90°

Cable types:  
E02=0.25mm<sup>2</sup> PVC Black  
E03=0.34mm<sup>2</sup> PVC Black  
E13=0.75mm<sup>2</sup> PVC Yellow  
E52=0.34mm<sup>2</sup> PVC Grey(RAL 7001)  
E57=0.34mm<sup>2</sup> PVC Grey(RAL 7001)  
H09=0.34mm<sup>2</sup> PUR Black  
H69=0.34mm<sup>2</sup> PUR Grey LSOH SCR  
I02=0.25mm<sup>2</sup> PVC Grey CEI  
I03=0.34mm<sup>2</sup> PVC Grey CEI  
I20=0.25mm<sup>2</sup> PVC Grey CEI SCR DC  
I26=0.34mm<sup>2</sup> PVC Grey CEI SCR AC  
P02=0.25mm<sup>2</sup> PUR/PVC Black  
P03=0.34mm<sup>2</sup> PUR/PVC Black  
P08=0.25mm<sup>2</sup> PUR Yellow HIFLEX  
P20=0.34mm<sup>2</sup> PUR Grey LSOH braid  
P82=0.34mm<sup>2</sup> PUR orange irradiated DC  
S20=0.34mm<sup>2</sup> PVC Yellow SJTO braid

Units:  
C = Centimeter  
M = Meter  
K = Kilometer  
F = Feet

Length  
Examples:  
020 = 2 M  
060 = 6 M  
100 = 10 M

Overmold color:  
Blank (Standard)=Black TPU  
Blank=Yellow PVC for cables  
A09, S19, S20, S26  
Blank=Yellow TPE-E for cables  
K03, K05  
A=Grey / G=Black / Y=Yellow

Coupling Nut:  
Blank (Standard)=Knurled Brass Ni Plated  
1=Hexagonal Stainless steel  
5=Knurled Derlin  
7=Knurled Brass Ni Plated, Teflon Coated  
Blank=7 for cables I20, I26, K03, K05, P82, S26  
9=Knurled / Hexagonal Brass Ni Plated SW13

H= 2 pcs. of I/D Carrier PVC Transparent  
(Cables lxx & P82 always with 2 pcs. of I/D Carrier even if no H in Engineering No.)

COUPLING NUT FEMALE MALE

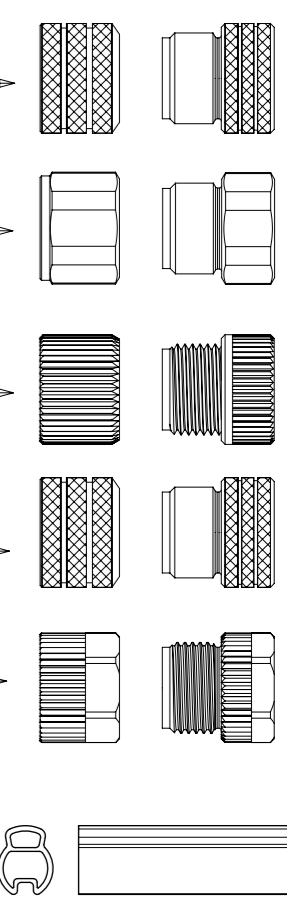

CABLE SPECIFICATION

CABLE TYPE	NO. OF WIRES	CROSS SECTION	CABLE JACKET	UL	CSA	STATIC: TEMP. / BENDING RADIUS	DYNAMIC: TEMP. / BENDING RADIUS	DRAG CHAIN	SHIELD
E03	3 / 4 / 5	0.34mm <sup>2</sup>	PVC BLACK	UL 2464/1729	C22.2 I/II A/B 80°C/300V	-30°C to +80°C, 10xO.D.	-10°C to +80°C, 15xO.D.	-	-
E13	3	AWG18	PVC YELLOW	UL 1731/AWM 2661	AWM C I/II A/B 80°C/300V	-	-	-	-
H09	3 / 4 / 5	0.34mm <sup>2</sup>	PUR BLACK LS0H	UL 21198/10493	C22.2 I/II A/B 80°C/300V	-40°C to +80°C, 5xO.D.	-25°C to +80°C, 10xO.D.	2 000 000 cycles at 20°C, Temp. range +5°C to +60°C	-
P03	3 / 4 / 5	0.34mm <sup>2</sup>	PUR / PVC BLACK	-	-	-30°C to +80°C, >7xO.D.	-5°C to +80°C, >15xO.D.	-	-
P82	4	0.34mm <sup>2</sup>	PUR IRR ORANGE	-	-	-50°C to +105°C,	-50°C to +105°C,	-	-
I03	4	0.34mm <sup>2</sup>	PVC GRAY	-	-	-30°C to +70°C	-5°C to +70°C	-	-
K03	4	AWG18	TPE YELLOW	ITC E195601 OR PLTC	AWM I/II A/B FT4 LL54185	-	-40°C to +105°C	-	-
K05	4	0.34mm <sup>2</sup>	TPE YELLOW	ITC E195601 OR PLTC	AWM I/II A/B FT4 LL54185	-	-40°C to +105°C	-	-
S20	4	0.34mm <sup>2</sup>	PVC YELLOW	UL 2661/1731	C22.2 AWM II	-30°C to +105°C	-40°C to +105°C	-	-

CONTACT POSITION FRONT VIEW:

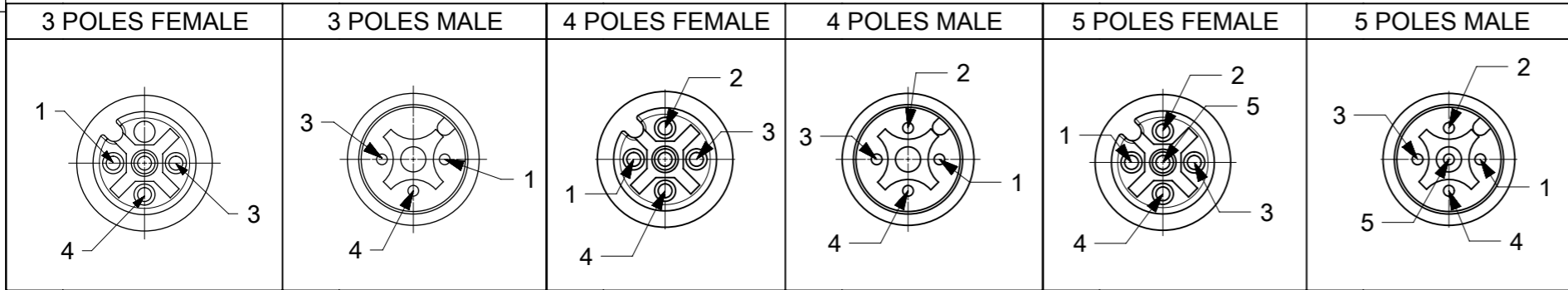

PIN	WIRE	PIN	WIRE	PIN	WIRE	PIN	WIRE	PIN	WIRE	PIN	WIRE	PIN	WIRE
1	BROWN	1	BROWN	1	BROWN	1	BROWN	1	BROWN	1	BROWN	1	BROWN
2	-	2	-	2	WHITE	2	WHITE	2	WHITE	2	WHITE	2	WHITE
3	BLUE	3	BLUE	3	BLUE	3	BLUE	3	BLUE	3	BLUE	3	BLUE
4	BLACK	4	BLACK	4	BLACK	4	BLACK	4	BLACK	4	BLACK	4	BLACK
5	-	5	-	5	-	5	-	5	GREY OR GREEN/YELLOW	5	GREY OR GREEN/YELLOW	5	GREY OR GREEN/YELLOW

CODING REQUIRED TO IEC 61076-2-101

DOCUMENT STATUS: P1 | RELEASE DATE: 2022/02/11 06:52:19

OVER	UPTO AND INCLUDING	TOLERANCE
0	305	+19
305	915	+45
915	1830	+56
1830	3660	+89
3660	7320	+165
7320	14640	+317
14640	30500	+610
30500	>	+2% OF LENGTH

THIS DRAWING CONTAINS INFORMATION THAT IS PROPRIETARY TO MOLEX ELECTRONIC TECHNOLOGIES, LLC AND SHOULD NOT BE USED WITHOUT WRITTEN PERMISSION

FUNCTIONAL SYMBOLS:  $\nabla/A = 0$ ,  $\nabla/E = 0$ ,  $\nabla/V = 0$

DIMENSION UNITS: mm | SCALE: 1:1

GENERAL TOLERANCES (UNLESS SPECIFIED):  
ANGULAR TOL: ± 1.0°  
4 PLACES: ±  
3 PLACES: ±  
2 PLACES: ± 0.05  
1 PLACE: ± 0.3  
0 PLACES: ± 0.5

DRAFT WHERE APPLICABLE MUST REMAIN WITHIN DIMENSIONS

THIRD ANGLE PROJECTION

DRAWING: A3-SIZE | SERIES: 120007

EC NO: 695290  
DRWN: MDHARMANTI | 2021/11/26  
CHK'D: RSILLER | 2022/02/11  
APPR: RSILLER | 2022/02/11

INITIAL REVISION:  
DRWN: DSOPPIN | 2018/09/27  
APPR: RSILLER | 2018/10/22

DOCUMENT NUMBER: 1200070187 | DOC TYPE: PSD | DOC PART: 000 | REVISION: A3

CUSTOMER: GENERAL MARKET | SHEET NUMBER: 2 OF 3

**molex**  
CSE M12 XP AC FE RA MA RA XM  
PRODUCT CUSTOMER DRAWING

# PART LIST

MOLEX PN	ENGINEERING PN	LENGTH (mm)
1200070187	883033E03M003	300
1200669514	883033E03M006H	600
1200070190	883033E03M020	2000
1200668685	883033E03M030	3000
1200668668	883033E03M050	5000
1200668398	883033E03M100	10000
1200668539	883033E03M150	15000
1200668253	883033E03M200	20000
1200668351	883033E13M005	500
1200668498	883033H09M010	1000
1200070203	883033I03M006	600
1200070204	883033I03M010	1000
1200070207	883033I03M050	5000
1200070208	883033I03M100	10000
1200071856	883033I03M1005	10000
1200070209	883033I03M150	15000
1200668295	883033P03M003	300
1200070215	883033P03M006	600
1200070216	883033P03M010	1000
1200070217	883033P03M020	2000
1200070817	883033P03M050	5000
1200668178	884033E03M003	300
1200669210	884033E03M0038	300
1200669211	884033E03M0068	600
1200668757	884033E03M008	800
1200070554	884033E03M010	1000
1200668192	884033E03M020	2000
1200072331	884033E03M0201	2000
1200070556	884033E03M030	3000
1200070557	884033E03M050	5000
1200668492	884033H09M010	1000
1200668240	884033H09M020	2000
1200668243	884033H09M050	5000
1200668260	884033I03M010	1000
1200668261	884033I03M020	2000
1200668262	884033I03M0305	3000
1200668263	884033I03M0505	5000
1200668264	884033I03M1005	10000
1200661370	884033K03M006	600
1200661371	884033K03M010	1000
1200661373	884033K03M020	2000
1200661374	884033K03M030	3000
1200661599	884033K03M036	3600

MOLEX PN	ENGINEERING PN	LENGTH (mm)
1200661376	884033K03M050	5000
1200661380	884033K05M005	500
1200661382	884033K05M010	1000
1200661383	884033K05M015	1500
1200661384	884033K05M020	2000
1200071524	884033P03M006	600
1200071523	884033P03M010	1000
1200668275	884033P03M015	1500
1200668332	884033P03M020	2000
1200668179	884033P03M020H	2000
1200668217	884033P03M030	3000
1200668298	884033P03M050	5000
1200669900	884033P03M100	10000
1200665041	884033P82M0037	300
1200071326	884033P82M0067	600
1200071327	884033P82M0107	1000
1200070565	884033S20M010	1000
1200665402	885033E03M010	1000
1200668529	885033E03M010H	1000
1200668675	885033E03M020	2000
1200668676	885033E03M030	3000
1200668677	885033E03M050	5000
1200668678	885033E03M100	10000
1200668499	885033H09M010	1000
1200668679	885033H09M020	2000
1200668680	885033H09M030	3000
1200668681	885033H09M050	5000
1200668682	885033H09M100	10000
1200668871	885033P03C130	130
1200668346	885033P03M003	300
1200668094	885033P03M010	1000
1200073087	885033P03M020	2000
1200072660	885033P03M030	3000
1200073088	885033P03M050	5000
1200072657	885033P03M0755	7500
1200073089	885033P03M100	10000

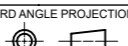
FUNCTIONAL SYMBOLS	THIS DRAWING CONTAINS INFORMATION THAT IS PROPRIETARY TO MOLEX ELECTRONIC TECHNOLOGIES, LLC AND SHOULD NOT BE USED WITHOUT WRITTEN PERMISSION		CURRENT REV DESC: ADDED NEW PNS							
	$\nabla_A = 0$ $\nabla_E = 0$ $\nabla_P = 0$	DIMENSION UNITS <b>mm</b>	SCALE <b>1:1</b>	GENERAL TOLERANCES (UNLESS SPECIFIED) ANGULAR TOL $\pm 1.0^\circ$ 4 PLACES $\pm$ 3 PLACES $\pm$ 2 PLACES $\pm 0.05$ 1 PLACE $\pm 0.3$ 0 PLACES $\pm 0.5$		EC NO: 695290 DRWN: MDHARMANTI 2021/11/26 CHK'D: RSILLER 2022/02/11 APPR: RSILLER 2022/02/11				
DIVISIONAL SYMBOLS	DRAFT WHERE APPLICABLE MUST REMAIN WITHIN DIMENSIONS		THIRD ANGLE PROJECTION 	DRAWING <b>A3-SIZE</b>	SERIES <b>120007</b>	INITIAL REVISION: DRWN: DSOPPIN 2018/09/27 APPR: RSILLER 2018/10/22	DOCUMENT NUMBER <b>1200070187</b>	DOC TYPE <b>PSD</b>	DOC PART <b>000</b>	REVISION <b>A3</b>
MATERIAL NUMBER SEE TABLE		CUSTOMER GENERAL MARKET		SHEET NUMBER 3 OF 3						

DOCUMENT STATUS	P1	RELEASE DATE	2022/02/11 06:52:19
-----------------	----	--------------	---------------------