

Features

- Surface mount
- 1:4 Impedance Ratio
- RoHS* Compliant
- Pb Free
- 260°C reflow compatible.
- Available on Tape and Reel

Description

MABA-008639-TC41T7 is a wire welded RoHS version of ETC4-1T-7. This 1:4 RF transformer is assembled in a low cost, surface mount package.

Ideally suited for high volume cellular and wireless applications. Typical applications include single to balanced mode conversion and impedance matching.

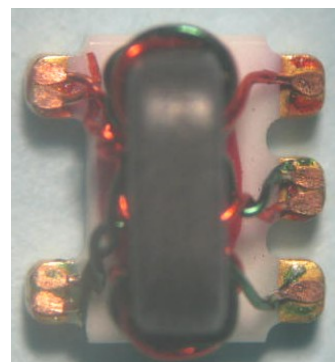

Schematic

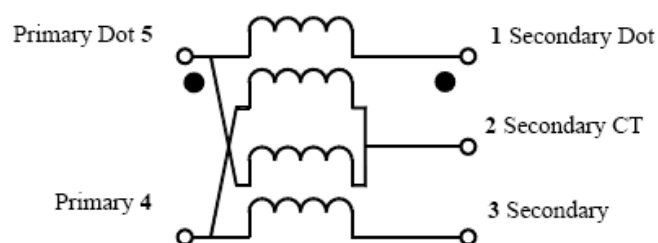

Ordering Information

Part Number	Package
MABA-008639-TC41T7	2000 piece reel

Pin Configuration

Pin No.	Function
1	Secondary Dot
2	Secondary CT
3	Secondary
4	Primary
5	Primary Dot

* Restrictions on Hazardous Substances, European Union Directive 2011/65/EU.

Electrical Specifications: $T_A = 25^\circ\text{C}$, $Z_0 = 50 \Omega$

Parameter	Frequency	Units	Min	Typ	Max
Insertion Loss	6 - 600 MHz	dB	—	—	2.0
	600 - 1000 MHz				3.0
Amplitude Unbalance	6 - 1000 MHz	dB	—	—	1.0
Phase Unbalance	6 - 1000 MHz	°	—	—	10

Recommended Maximum Ratings^{1,2}

Parameter	Value
RF Power	250 mW
DC Current	30 mA
Operating Temperature	-40°C to +85°C
Storage Temperature	-55°C to +100°C

1. Exceeding any one or combination of these limits may cause permanent damage to this device.
2. MACOM does not recommend sustained operation near these survivability limits.

Typical Performance Curves

Insertion Loss

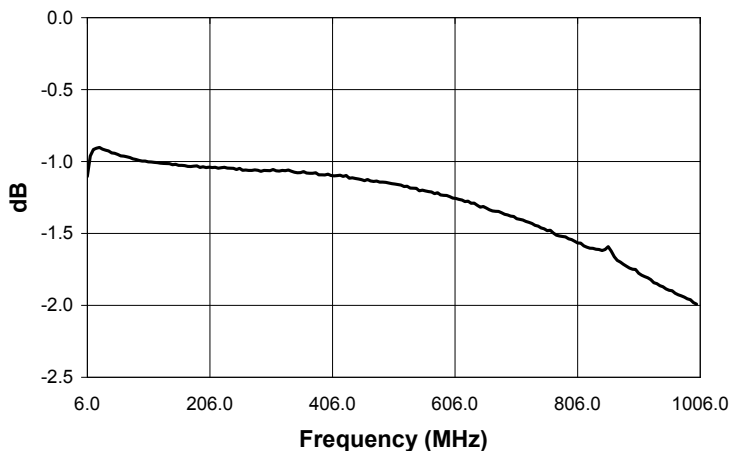

Phase Unbalance

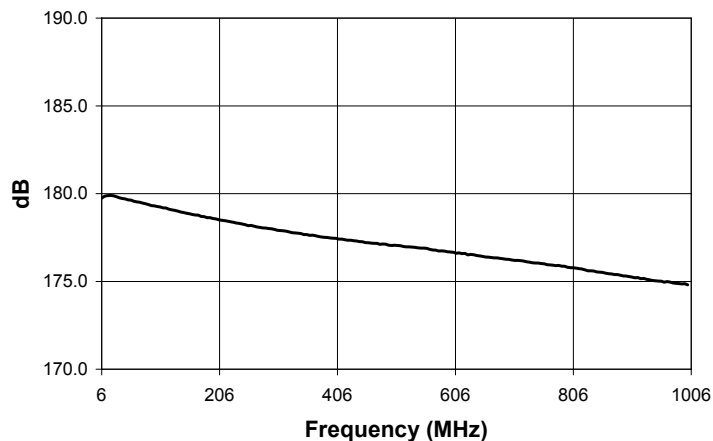

Amplitude Unbalance

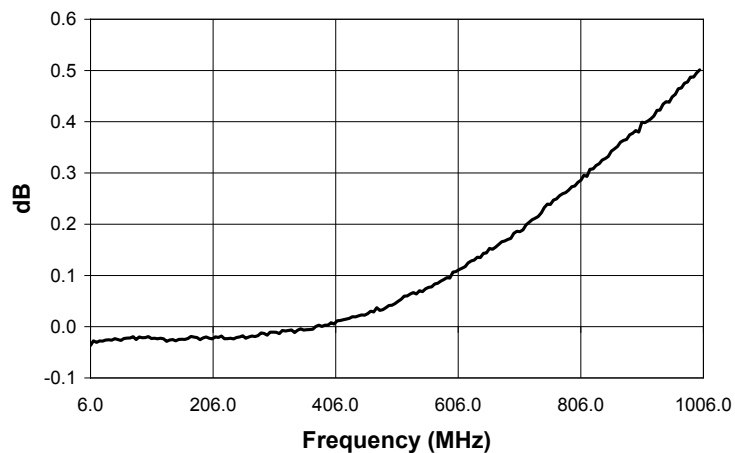

Component Dimensions

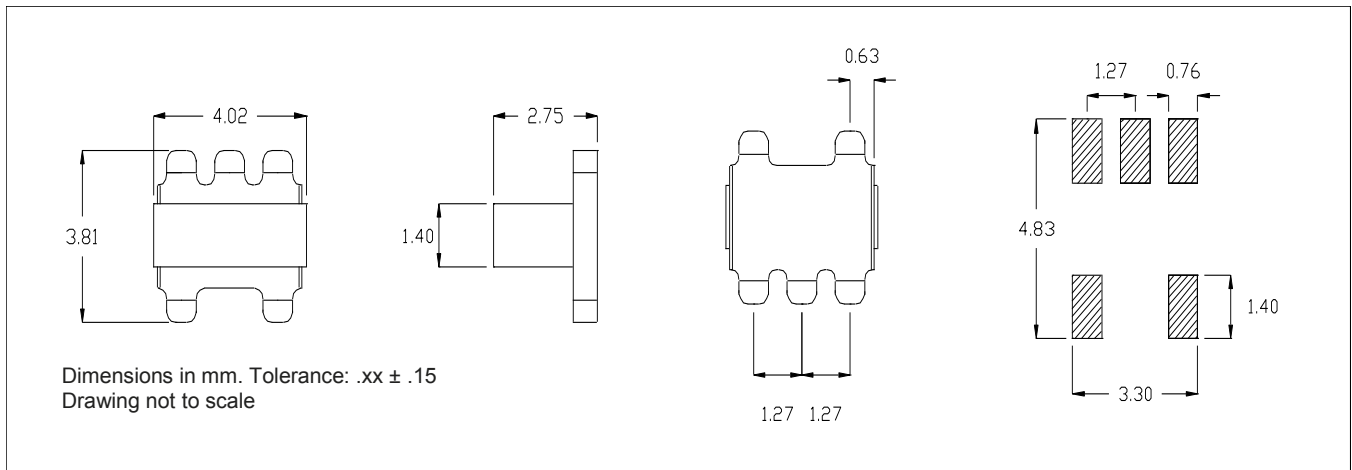

Tape & Reel Information

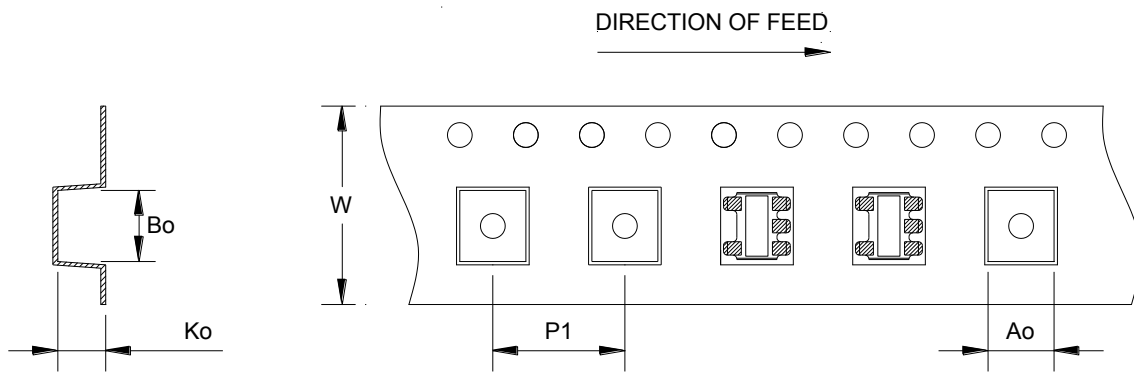

Item	Dimension
Ao	4.00mm +/-0.1mm
Bo	4.30mm +/-0.1mm
Ko	2.90mm +/-0.1mm
W	12.00mm +/-0.3mm
P1	8.00mm +/-0.1mm

M/A-COM Technology Solutions Inc. All rights reserved.

Information in this document is provided in connection with M/A-COM Technology Solutions Inc ("MACOM") products. These materials are provided by MACOM as a service to its customers and may be used for informational purposes only. Except as provided in MACOM's Terms and Conditions of Sale for such products or in any separate agreement related to this document, MACOM assumes no liability whatsoever. MACOM assumes no responsibility for errors or omissions in these materials. MACOM may make changes to specifications and product descriptions at any time, without notice. MACOM makes no commitment to update the information and shall have no responsibility whatsoever for conflicts or incompatibilities arising from future changes to its specifications and product descriptions. No license, express or implied, by estoppel or otherwise, to any intellectual property rights is granted by this document.

THESE MATERIALS ARE PROVIDED "AS IS" WITHOUT WARRANTY OF ANY KIND, EITHER EXPRESS OR IMPLIED, RELATING TO SALE AND/OR USE OF MACOM PRODUCTS INCLUDING LIABILITY OR WARRANTIES RELATING TO FITNESS FOR A PARTICULAR PURPOSE, CONSEQUENTIAL OR INCIDENTAL DAMAGES, MERCHANTABILITY, OR INFRINGEMENT OF ANY PATENT, COPYRIGHT OR OTHER INTELLECTUAL PROPERTY RIGHT. MACOM FURTHER DOES NOT WARRANT THE ACCURACY OR COMPLETENESS OF THE INFORMATION, TEXT, GRAPHICS OR OTHER ITEMS CONTAINED WITHIN THESE MATERIALS. MACOM SHALL NOT BE LIABLE FOR ANY SPECIAL, INDIRECT, INCIDENTAL, OR CONSEQUENTIAL DAMAGES, INCLUDING WITHOUT LIMITATION, LOST REVENUES OR LOST PROFITS, WHICH MAY RESULT FROM THE USE OF THESE MATERIALS.

MACOM products are not intended for use in medical, lifesaving or life sustaining applications. MACOM customers using or selling MACOM products for use in such applications do so at their own risk and agree to fully indemnify MACOM for any damages resulting from such improper use or sale.