

Xinger®

Ultra Low Profile 0404 Balun 50Ω to 50Ω Balanced

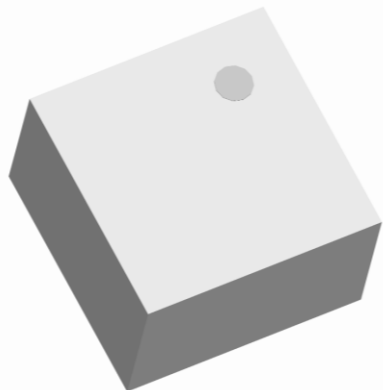

Description

The BD2239N5050AHF is a low profile, low impedance sub-miniature unbalanced to balanced transformer designed for differential inputs and output locations on modern chipset applications in an easy to use surface mount package. The BD2239N5050AHF is ideal for high volume manufacturing and delivers higher performance than traditional ceramic baluns. The BD2239N5050AHF has an unbalanced port impedance of 50Ω and a 50Ω balanced port impedance. The output ports have equal amplitude (-3dB) with 180 degree phase differential. The BD2239N5050AHF is available on tape and reel for pick and place high volume manufacturing.

Detailed Electrical Specifications: Specifications subject to change without notice.

Parameter	ROOM (25°C)												
	Min.	Typ.	Max	Min.	Typ.	Max	Min.	Typ.	Max	Min.	Typ.	Max	Unit
Frequency	2200		2800	3300		3900	2200		3900	3900		4200	MHz
Unbalanced Port Impedance		50			50			50			50		Ω
Balanced Port Impedance		50			50			50			50		Ω
Return Loss	13	18		8	11		8	11		7	10		dB
Insertion Loss*		0.7	1.1		1.2	1.6		1.2	1.6		1.4	1.8	dB
Amplitude Balance		0.5	1		0.8	1.4		0.8	1.4		0.8	1.4	dB
Phase Balance		3.4	7		3.3	8		3.3	8		4.7	9	Degrees
CMRR		28			26			26			26		dB
Power Handling @85C			0.75			0.75			0.75			0.75	Watts
Operating Temperature	-55		+105	-55		+105	-55		+105	-55		+105	°C

* Insertion Loss stated at room temperature (Insertion Loss is approximately 0.1 dB higher at +85 °C)

Outline Drawing

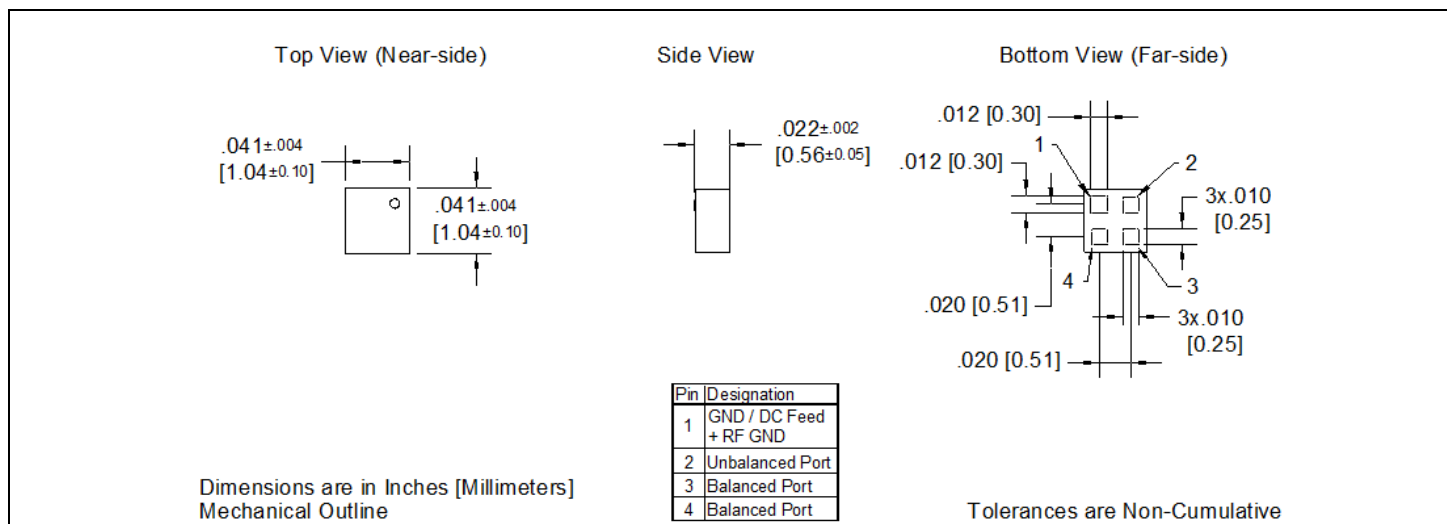

Typical Performance: 2200 MHz to 4200 MHz

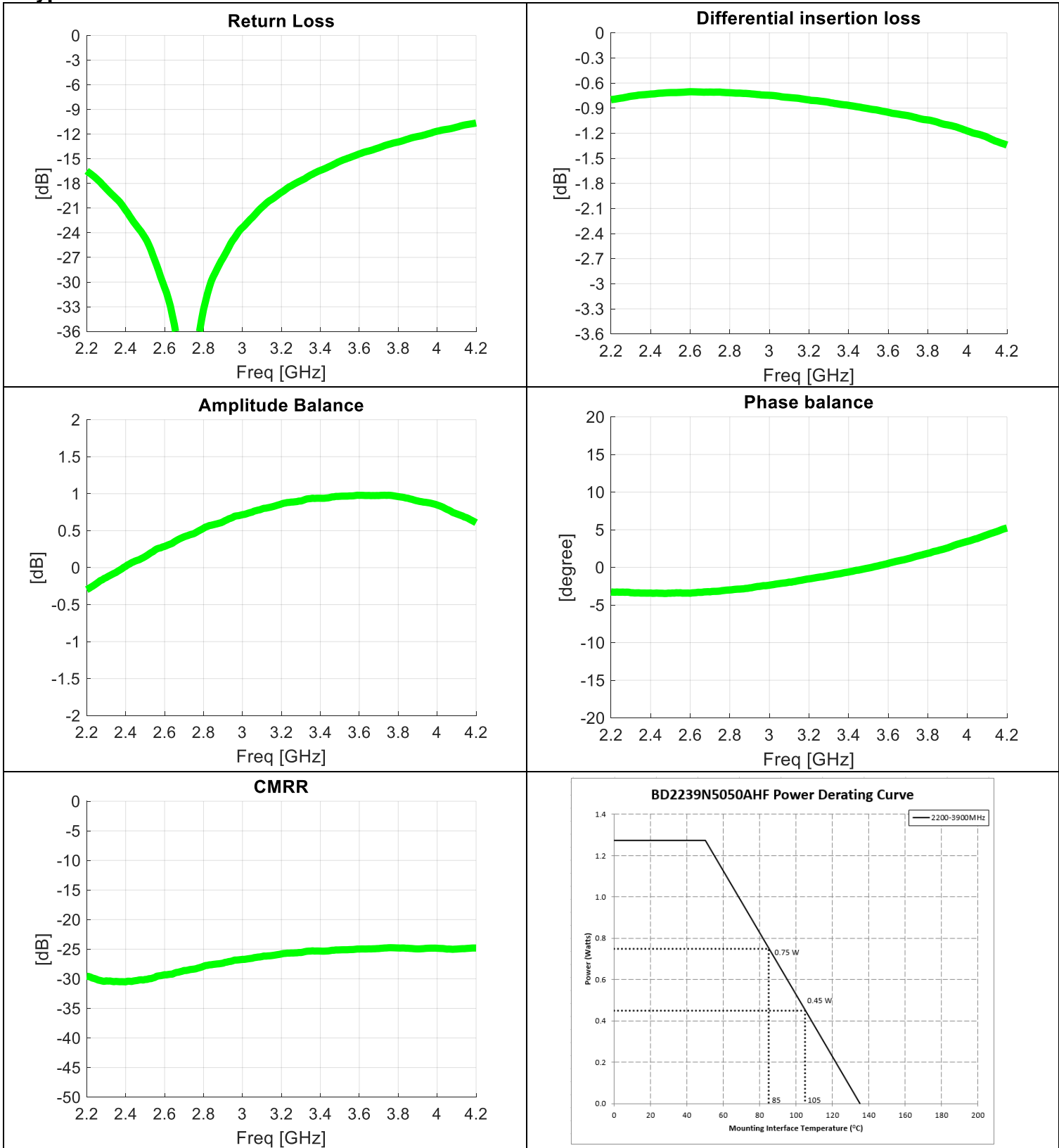

USA/Canada: (315) 432-8909
 Toll Free: (800) 411-6596
 Europe: +44 2392-232392

Available on Tape and Reel for Pick and Place Manufacturing.



Wide Band Performance: 10 MHz to 8100 MHz

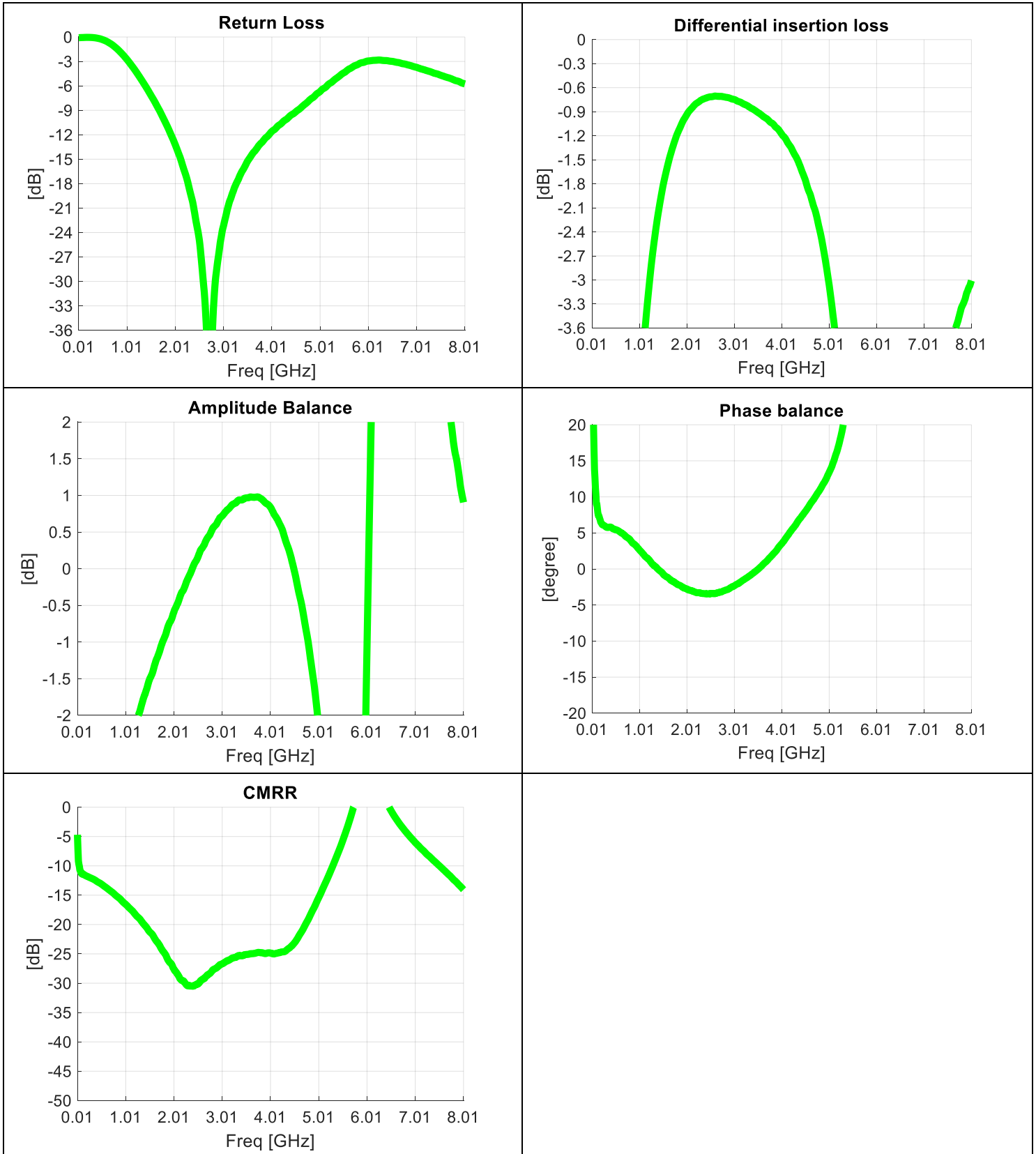

Mounting Configuration:

In order for Xinger surface mount components to work optimally, the proper impedance transmission lines must be used to connect to the RF ports. If this condition is not satisfied, insertion loss, Isolation and VSWR may not meet published specifications.

All of the Xinger components are constructed from ceramic filled PTFE composites which possess excellent electrical and mechanical stability having X and Y thermal coefficient of expansion (CTE) of 17 ppm/°C.

An example of the PCB footprint used in the testing of these parts is shown below. An example of a DC-biased footprint is also shown below. In specific designs, the transmission line widths need to be adjusted to the unique dielectric coefficients and thicknesses as well as varying pick and place equipment tolerances.

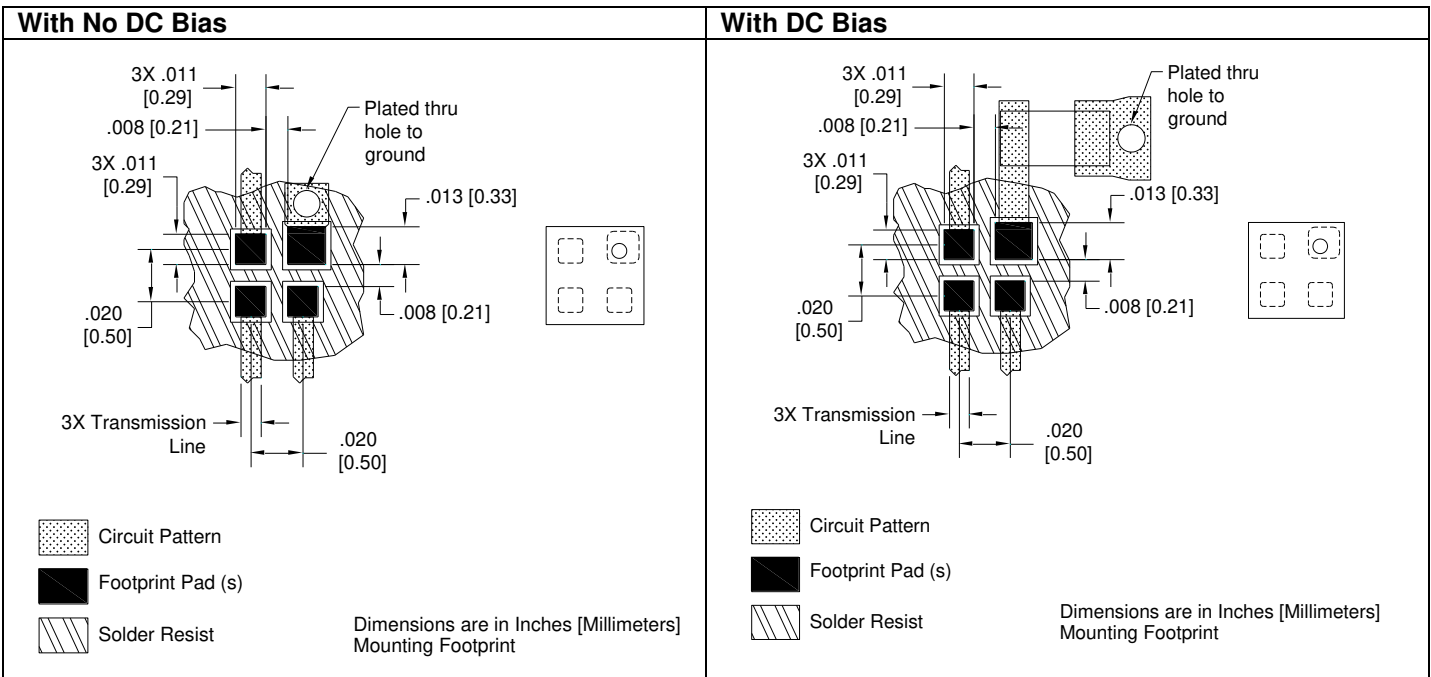

Packaging and Ordering Information

Parts are available in reel and are packaged per EIA 481-D. Parts are oriented in tape and reel as shown below. Minimum order quantities are 4000 per reel.

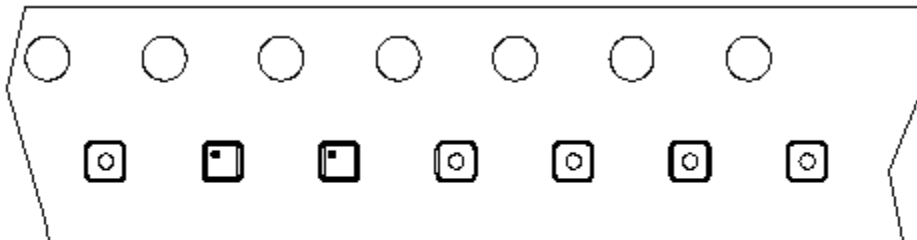

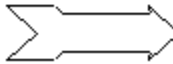
Direction of
Part Feed
(Unloading) 

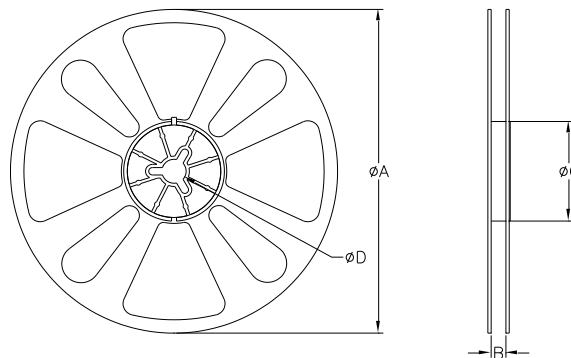

TABLE 1		
QUANTITY/REEL	REEL DIMENSIONS mm	
4000	øA	177.80
	B	8.00
	øC	50.80
	øD	13.00

