

QT-Brightek PLCC Series

2014 PLCC2 LED

Part No.: QBLP675-R-2897

2897: High Brightness Version

Product: QBLP675-R-2897	Date: July 17 th , 2019	Page 1 of 9
	Version# 1.0	

Table of Contents:

Introduction	3
Electrical / Optical Characteristic (Ta=25 °C)	4
Absolute Maximum Rating	4
Characteristic Curves.....	5
Solder Profile & Footprint.....	6
Packing	7
Labeling	8
Ordering Information	8
Revision History	9
Disclaimer	9

Introduction

Feature:

- Package in tape and reel
- Water clear lens
- Ultra bright reflector type 2014 PLCC2 LED
- AllInGaP technology
- Viewing angle: 120 deg. Typ.

Description:

This ultra-bright 2014 LED has a height profile of 1.30mm. Combination of high brightness output and robust package, this LED is ideal for back lighting, architecture lighting, and industrial equipment lighting applications.

Application:

- Status indication
- Industrial equipment backlighting
- Architecture lighting

Certification & Compliance:

- TS16949
- ISO9001
- RoHS Compliant



Dimension:

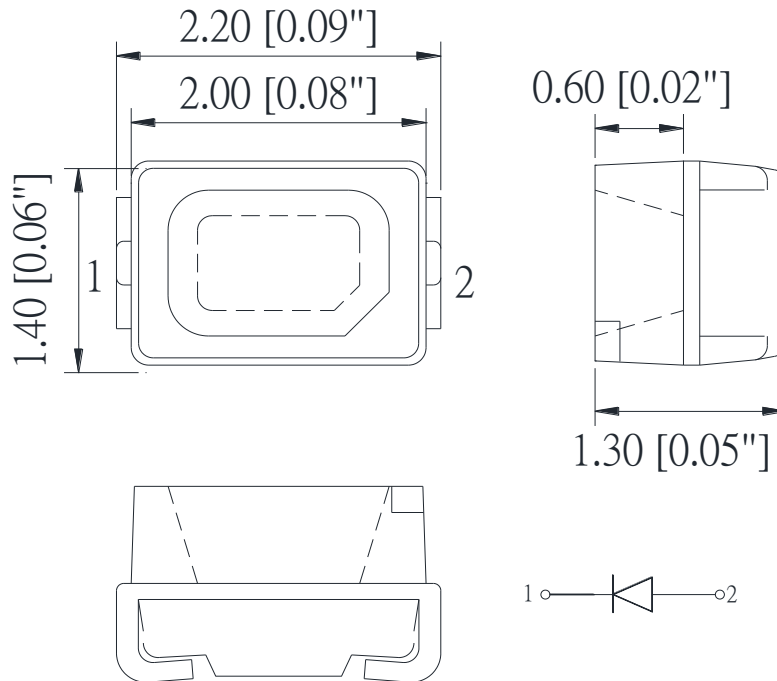

Units: mm / tolerance = +/-0.2mm

Electrical / Optical Characteristic (Ta=25 °C)

Product	Color	I _F (mA)	V _F (V)		λ _D (nm)			I _V (mcd)	
			Typ.	Max.	Min.	Typ.	Max.	Min.	Typ.
QBLP675-R-2897	Red	20	1.9	2.5	615	620	630	250	467

Absolute Maximum Rating

Material	P _d (mW)	I _F (mA)	I _{FP} (mA)*	V _R (V)	T _{OP} (°C)	T _{ST} (°C)	T _{SOL} (°C)**
AllnGaP	75	30	125	5	-40 ~ +80	-40 ~ +85	260

*Duty 1/8 @ 1KHz

**IR Reflow for no more than 10 sec @ 260 °C

Forward Voltage V_F @ I_F=20mA

Bin	Min.	Max.	Unit
□	1.7	2.5	V

Dominant Wavelength λ_D @ I_F=20mA

Bin	Min.	Max.	Unit
s	615	620	nm
t	620	625	
u	625	630	

Luminous Intensity I_V @ I_F=20mA

Bin	Min.	Max.	Unit
N	250	320	mcd
O	320	400	
P	400	500	
Q	500	630	
R	630	800	

Characteristic Curves

AllnGaP

Relative Intensity vs. Wavelength

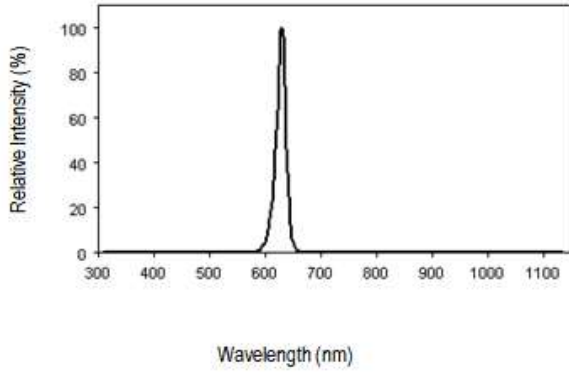

Forward Current vs. Forward Voltage

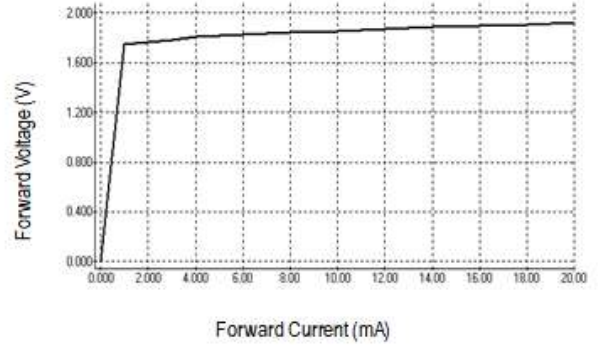

Directive Characteristics

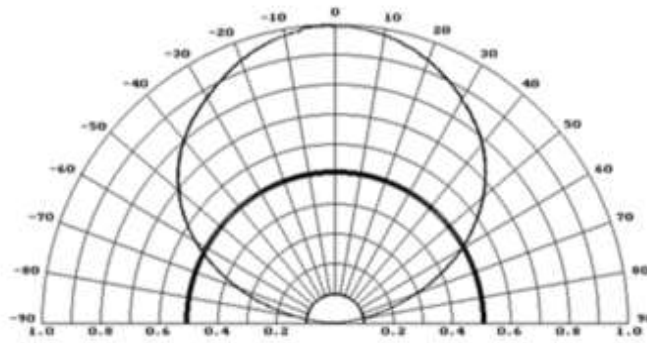

Solder Profile & Footprint

-The recommended reflow soldering profile is as follows (temperatures indicated are as measured on the surface of the LED resin):

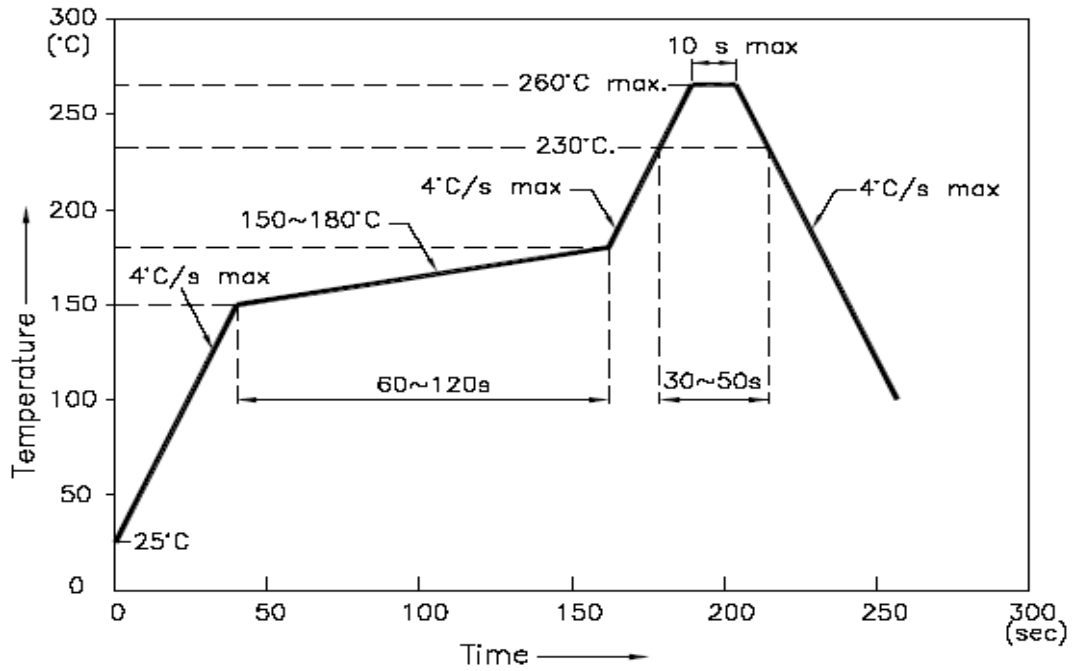

Recommended Pad Layout

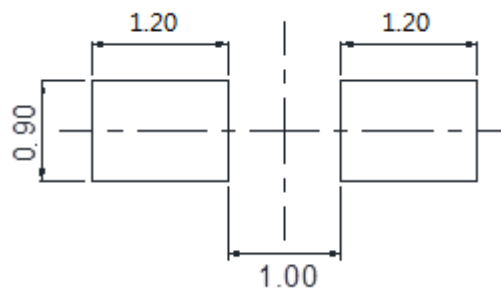

Units: mm

Packing

Reel Dimension:

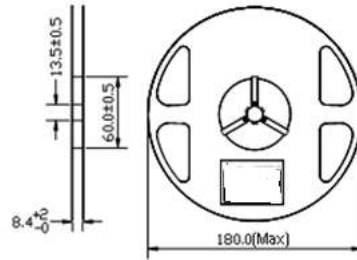

Unit: mm

Tape Dimension:

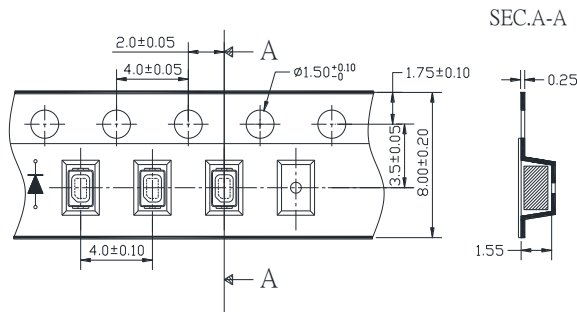

Unit: mm

Arrangement of Tape:

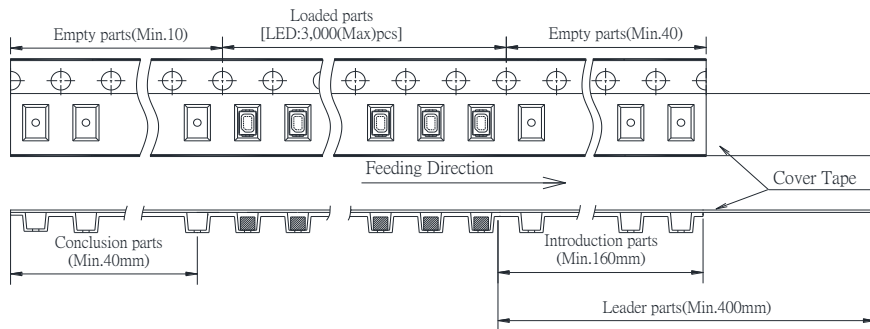

Packaging Specification:

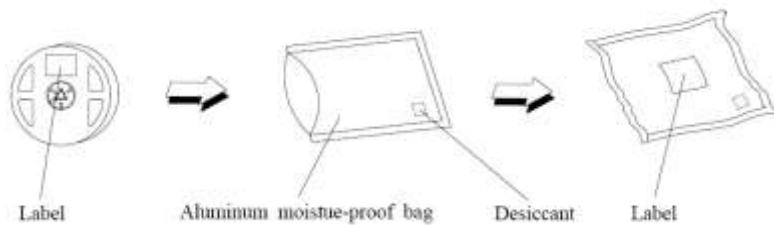

Product: QBLP675-R-2897	Date: July 17 th , 2019	Page 7 of 9
	Version# 1.0	

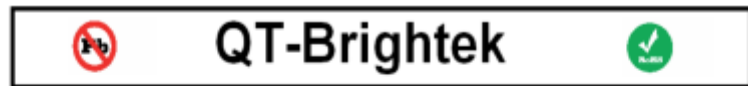
Labeling

Part No: _____

Customer P/N: _____

Item: _____

Q'ty: _____

Vf: _____

Iv: _____

Wl: _____

Date: _____

Made in China**Ordering Information**

Part #	Orderable Part #	Spec Range	Quantity per reel
QBLP675-R-2897	QBLP675-R-2897	Iv=467mcd typ. @ 20mA / Color=615nm to 630nm	3,000 units

Revision History

Description:	Revision #	Revision Date
New Release of QBLP675-R-2897	V1.0	07/17/2019

Disclaimer

QT-BRIGHTTEK reserves the right to make changes without further notice to any products herein to improve reliability, function or design. QT-BRIGHTTEK does not assume any liability arising out of the application or use of any product or circuit described herein; neither does it convey any license under its patent rights, nor the rights of others.

Life Support Policy

QT-BRIGHTTEK's products are not authorized for use as critical components in life support devices or systems without the express written approval of QT-BRIGHTTEK. As used herein:

1. Life support devices or systems are devices or systems which, (a) are intended for surgical implant into the body, or (b) support or sustain life, and (c) whose failure to perform when properly used in accordance with instructions for use provided in the labeling, can be reasonably expected to result in a significant injury of the user.
2. A critical component in any component of a life support device or system whose failure to perform can be reasonably expected to cause the failure of the life support device or system, or to affect its safety or effectiveness.