



Part Number: D3I0507

Electrical Specifications

Frequency Range (GHz):	0.5 – 0.7
Isolation (dB):	17 MIN
Insertion Loss (dB):	0.6 MAX
VSWR:	1.35:1 MIN
Forward Power (W):	300 AVG 750 PK
Reflective Power (W):	2 AVG

Mechanical/Environmental Specifications

Connector Type:	SMA
Connector Body:	Passivated stainless steel
Connector Pin:	Gold plated copper
Load Body:	Brass
Magnetic Shunt:	Nickel plated CRS
Operational Temp:	-20°C to +65°C
Weight (oz)	5.5 MAX

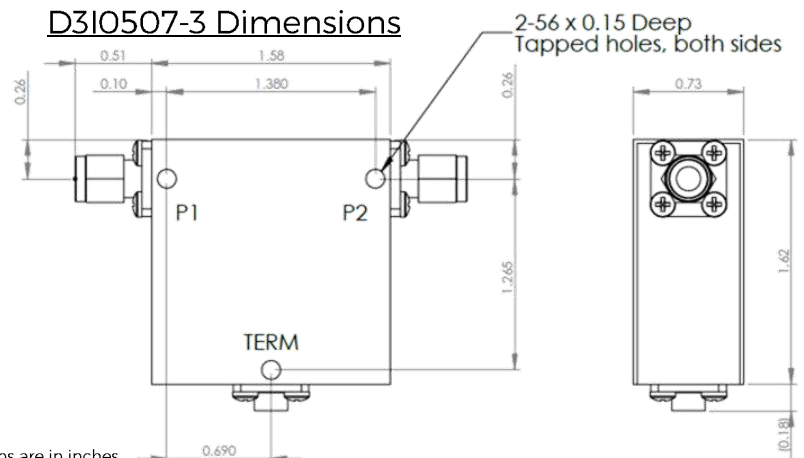
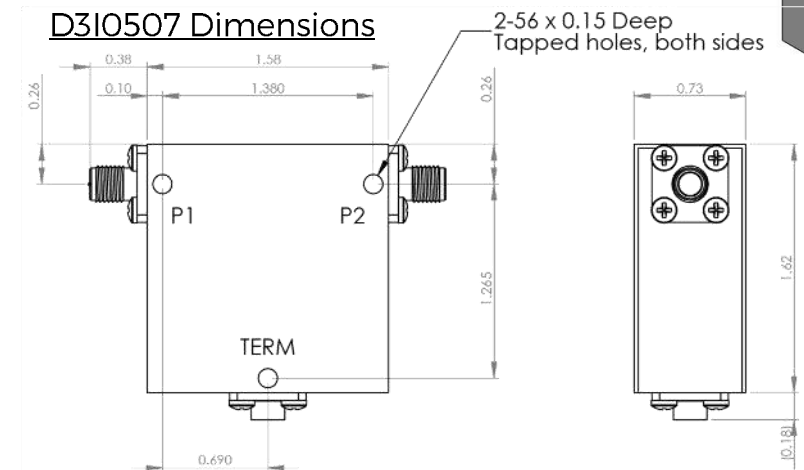
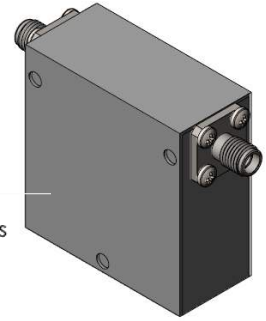

Dimensions are in inches
Tolerance

XX ±0.03
XXX ±0.010

Type of Device	PN Suffix	Connector Configuration Input / Output	PN Example
Single and Dual Junction Isolator, 2-Port Device	N/A	Female / Female	D3I0507
	-1	Male / Female	D3I0507-1
	-2	Female / Male	D3I0507-2
	-3	Male / Male	D3I0507-3



MEASURED DATA

Part Number: D3I0507, +25°C

