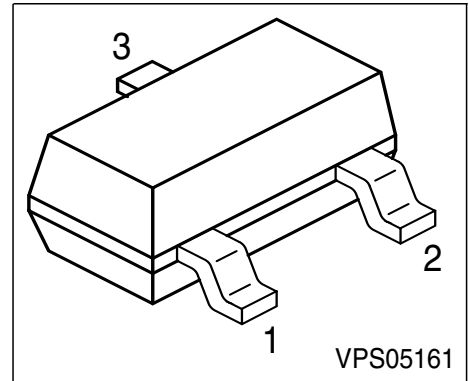
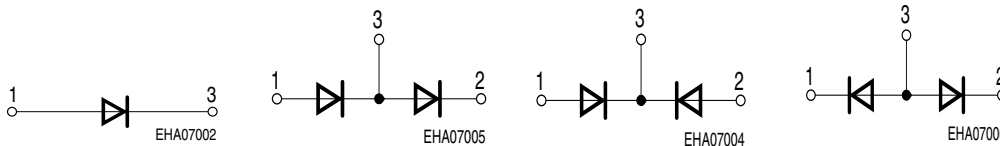

Silicon PIN Diodes

- PIN diode for high speed switching of RF signals
- Low forward resistance
- Very low capacitance
- For frequencies up to 3 GHz

BAR 63
BAR 63-04
BAR 63-05
BAR 63-06

Type	Marking	Pin Configuration			Package
BAR 63	G3s	1 = A	2 n.c.	3 = C	SOT-23
BAR 63-04	G4s	1 = A1	2 = C2	3=C1/A2	SOT-23
BAR 63-05	G5s	1 = A1	2 = A2	3=C1/C2	SOT-23
BAR 63-06	G6s	1 = C1	2 = C2	3=A1/A2	SOT-23

Maximum Ratings

Parameter	Symbol	Value	Unit
Diode reverse voltage	V_R	50	V
Forward current	I_F	100	mA
Total power dissipation BAR 63, $T_S \leq 80^\circ\text{C}$	P_{tot}	250	mW
BAR 63-04, BAR 63-05, BAR 63-06, $T_S \leq 55^\circ\text{C}$	P_{tot}	250	
Operating temperature range	T_{op}	-55 ... 150	$^\circ\text{C}$
Storage temperature	T_{stg}	-55 ... 150	

Thermal Resistance

Junction-ambient ¹⁾ BAR 63	R_{thJA}	≤ 450	K/W
Junction-ambient ¹⁾ BAR 63-04,05,06	R_{thJA}	≤ 540	
Junction-soldering point BAR 63	R_{thJS}	≤ 280	
Junction-soldering point BAR 63-04,05,06	R_{thJS}	≤ 380	

1) Package mounted on alumina 15mm x 16.7mm x 0.7mm

Electrical Characteristics at $T_A = 25^\circ\text{C}$, unless otherwise specified.

Parameter	Symbol	Values			Unit
		min.	typ.	max.	
DC characteristics					
Breakdown voltage $I_{(BR)} = 5 \mu\text{A}$	$V_{(BR)}$	50	-	-	V
Reverse current $V_R = 20 \text{ V}$	I_R	-	-	50	nA
Forward voltage $I_F = 100 \text{ mA}$	V_F	-	0.95	1.2	V
AC characteristics					
Diode capacitance $V_R = 0 \text{ V}, f = 100 \text{ MHz}$ $V_R = 5 \text{ V}, f = 1 \text{ MHz}$	C_T	- -	0.3 0.21	- 0.3	pF
Forward resistance $I_F = 5 \text{ mA}, f = 100 \text{ MHz}$ $I_F = 10 \text{ mA}, f = 100 \text{ MHz}$	r_f	- -	1.2 1	2 -	Ω
Charge carrier life time $I_F = 10 \text{ mA}, I_R = 6 \text{ mA}, I_R = 3 \text{ mA}$	τ_{rr}	-	75	-	ns
Series inductance	L_s	-	1.8	-	nH

Forward current $I_F = f(T_A; T_S)$

BAR 63

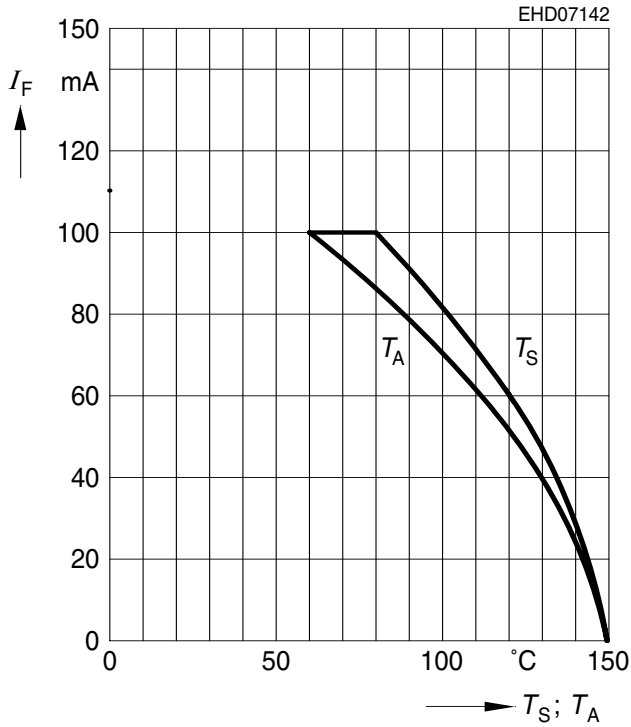

Forward current $I_F = f(T_A; T_S)$

BAR 63-04, -05, -06

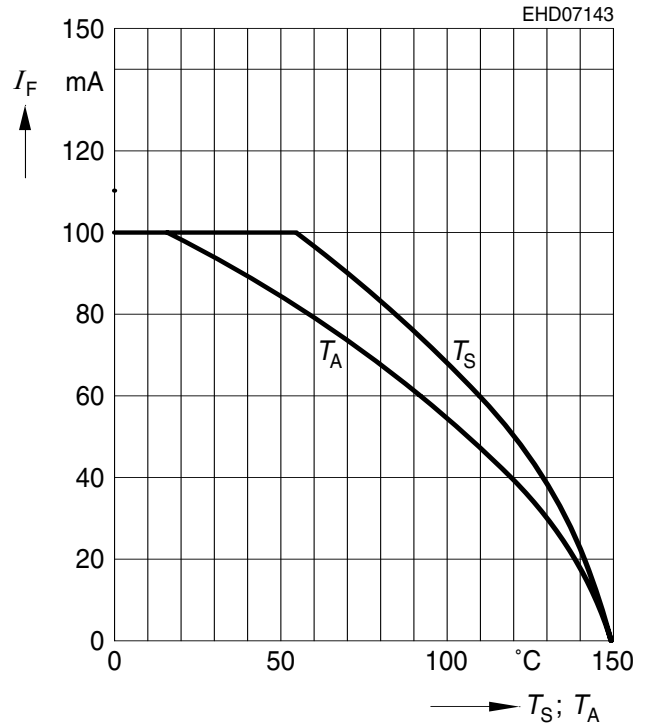

Permissible pulse load $R_{thJS} = f(t_p)$

BAR 63

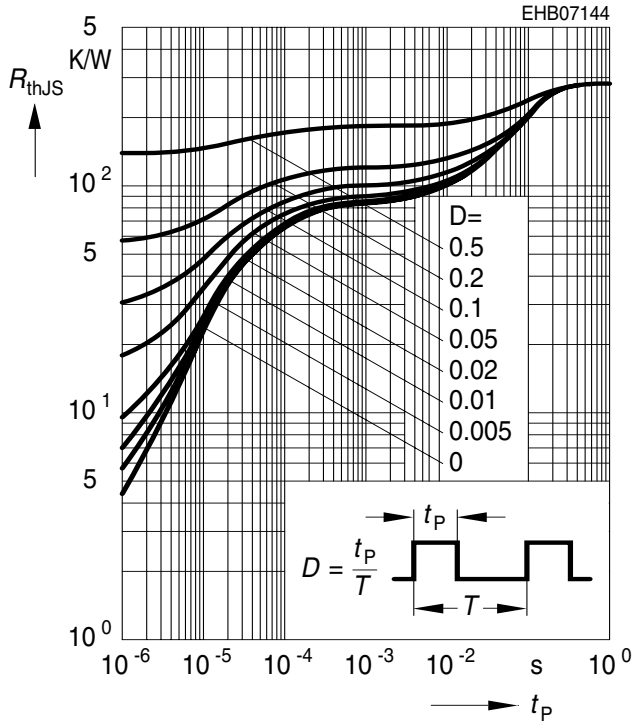

Permissible pulse load $R_{thJS} = f(t_p)$

BAR 63-04, -05, -06

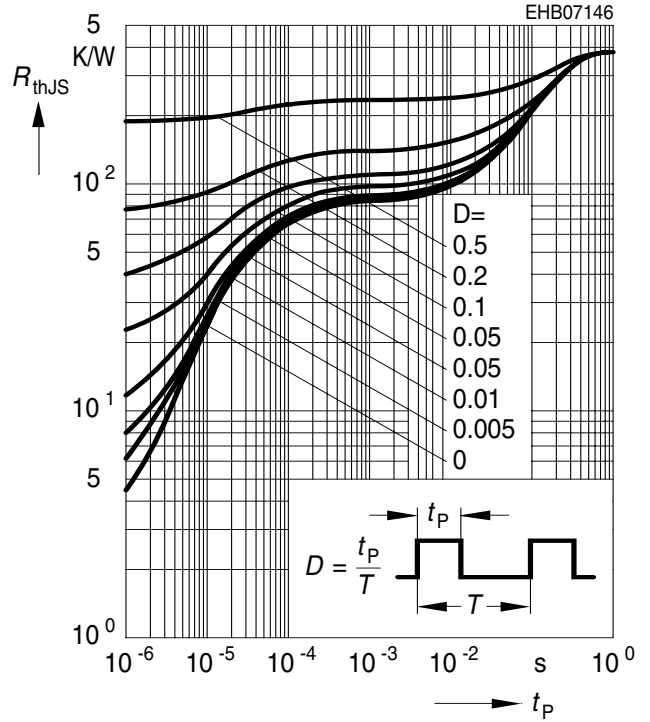

Permissible pulse load $I_{Fmax} / I_{FDC} = f(t_p)$

BAR 63

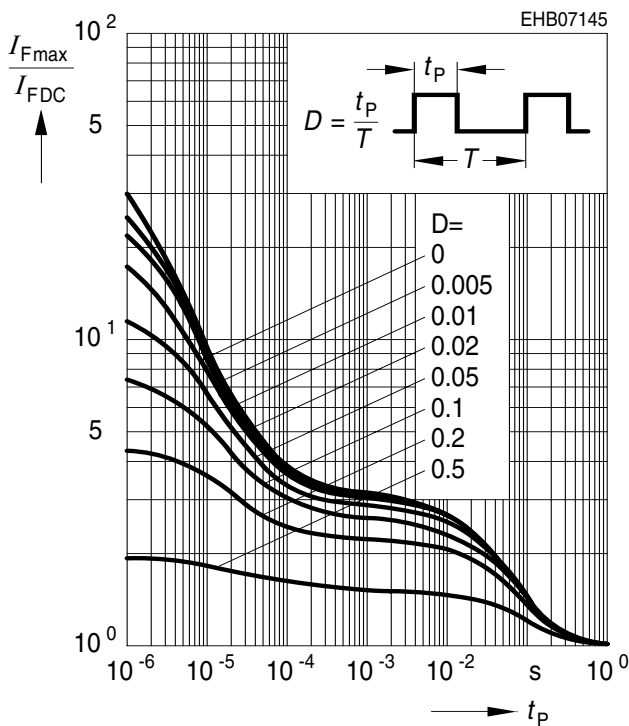

Permissible pulse load $I_{Fmax} / I_{FDC} = f(t_p)$

BAR 63-04, -05, -06

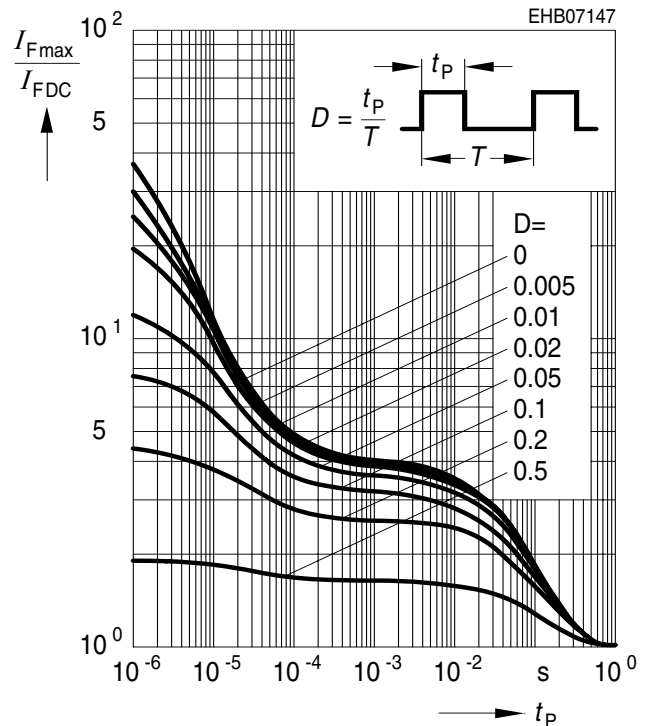

Forward resistance $r_f = f(I_F)$

$f = 100\text{MHz}$

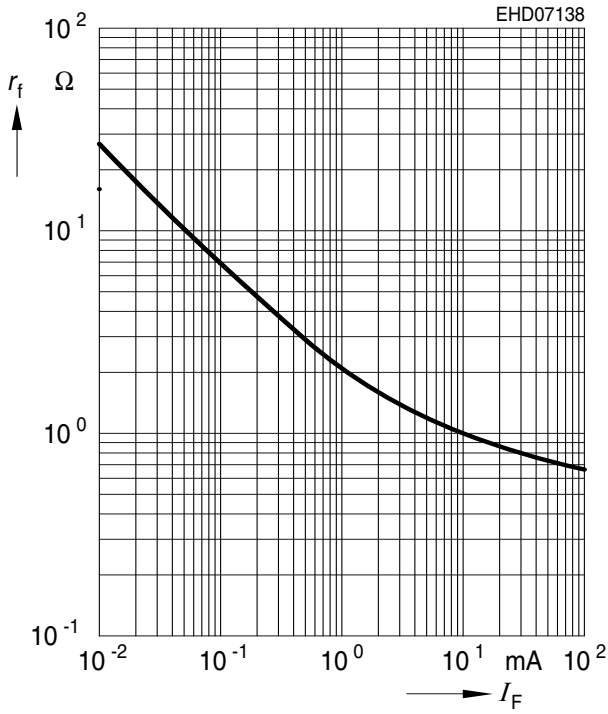

Diode capacitance $C_T = f(V_R)$

$f = 1\text{MHz}$

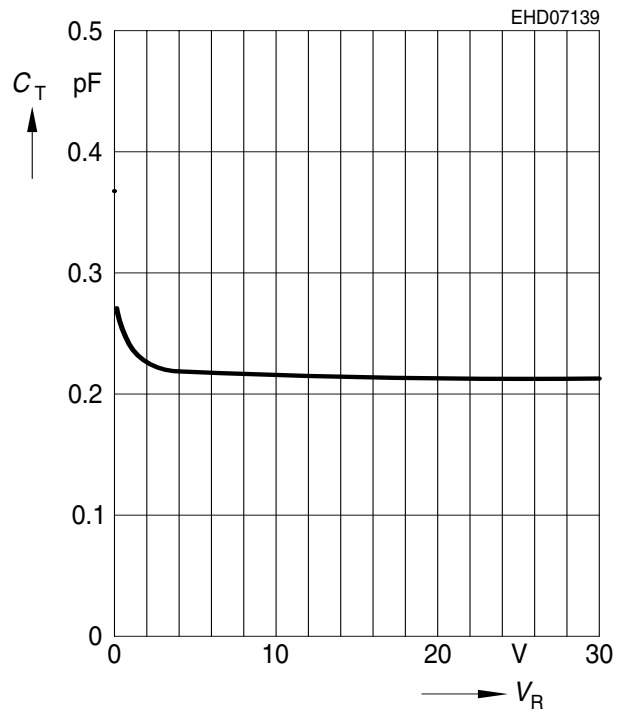

Forward current $I_F = f(V_F)$

$T_A = \text{Parameter}$

