



**EUROCARD**

TE Internal #: 9-1393644-1

Eurocard Connectors, Plug, Board-to-Board, 96 Position, .1 in [2.54 mm] Centerline, Printed Circuit Board, 3 Row, Right Angle, 32 Column

[View on TE.com >](#)

Connectors > PCB Connectors > Backplane Connectors > Eurocard Connectors

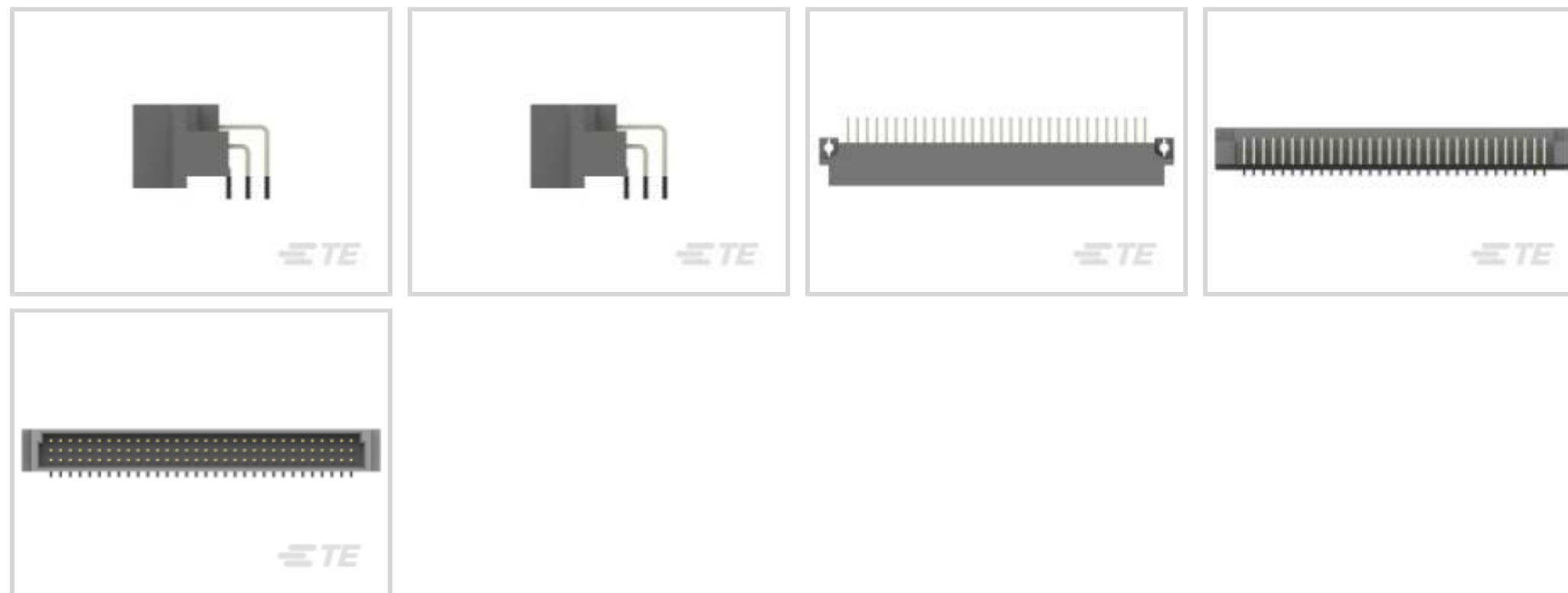

Connector & Housing Type: **Plug**

Connector System: **Board-to-Board**

Termination Post & Tail Length: **3 mm [ .118 in ]**

Number of Positions: **96**

Centerline (Pitch): **2.54 mm [ .1 in ]**

**Features**

**Product Type Features**

Connector & Housing Type	Plug
Connector System	Board-to-Board
Connector & Contact Terminates To	Printed Circuit Board
DIN Size	Standard
DIN Level	II

**Configuration Features**

Number of Positions	96
Number of Rows	3
PCB Mount Orientation	Right Angle
Number of Columns	32
Number of Signal Positions	96
Rows Loaded	A, B, C

**Contact Features**

Contact Type	Pin
--------------	-----



Contact Base Material	Phosphor Bronze
-----------------------	-----------------

Contact Current Rating (Max)	1.5 A
------------------------------	-------

#### Termination Features

Termination Method to Printed Circuit Board	Through Hole - Solder
---	-----------------------

Termination Post & Tail Length	3 mm[.118 in]
--------------------------------	---------------

#### Mechanical Attachment

Mating Alignment Type	Polarization
-----------------------	--------------

Mating Alignment	With
------------------	------

Panel Mount Feature	Without
---------------------	---------

PCB Mount Retention	With
---------------------	------

PCB Mount Retention Type	Mounting Hole
--------------------------	---------------

Connector Mounting Type	Board Mount
-------------------------	-------------

#### Housing Features

Housing Material	Polyester - GF
------------------	----------------

Centerline (Pitch)	2.54 mm[.1 in]
--------------------	----------------

#### Dimensions

Connector Height	18.08 mm
------------------	----------

PCB Thickness (Recommended)	1.6 mm[.063 in]
-----------------------------	-----------------

Row-to-Row Spacing	2.54 mm[.1 in]
--------------------	----------------

#### Usage Conditions

Operating Temperature Range	-55 – 105 °C[-67 – 221 °F]
-----------------------------	----------------------------

#### Operation/Application

Shielded	No
----------	----

Circuit Application	Signal
---------------------	--------

#### Industry Standards

UL Flammability Rating	UL 94V-0
------------------------	----------

#### Packaging Features

Packaging Method	Tray
------------------	------

#### Product Compliance

[For compliance documentation, visit the product page on TE.com>](#)







EU RoHS Directive 2011/65/EU	Compliant
EU ELV Directive 2000/53/EC	Compliant
China RoHS 2 Directive MIIT Order No 32, 2016	No Restricted Materials Above Threshold
EU REACH Regulation (EC) No. 1907/2006	Current ECHA Candidate List: JUNE 2023 (235) Candidate List Declared Against: JAN 2023 (233) Does not contain REACH SVHC
Halogen Content	Not Low Halogen - contains Br or Cl > 900 ppm.
Solder Process Capability	Wave solder capable to 240°C

Product Compliance Disclaimer

This information is provided based on reasonable inquiry of our suppliers and represents our current actual knowledge based on the information they provided. This information is subject to change. The part numbers that TE has identified as EU RoHS compliant have a maximum concentration of 0.1% by weight in homogenous materials for lead, hexavalent chromium, mercury, PBB, PBDE, DBP, BBP, DEHP, DIBP, and 0.01% for cadmium, or qualify for an exemption to these limits as defined in the Annexes of Directive 2011/65/EU (RoHS2). Finished electrical and electronic equipment products will be CE marked as required by Directive 2011/65/EU. Components may not be CE marked. Additionally, the part numbers that TE has identified as EU ELV compliant have a maximum concentration of 0.1% by weight in homogenous materials for lead, hexavalent chromium, and mercury, and 0.01% for cadmium, or qualify for an exemption to these limits as defined in the Annexes of Directive 2000/53/EC (ELV). Regarding the REACH Regulation, the information TE provides on SVHC in articles for this part number is based on the latest European Chemicals Agency (ECHA) 'Guidance on requirements for substances in articles' posted at this URL: <https://echa.europa.eu/guidance-documents/guidance-on-reach>

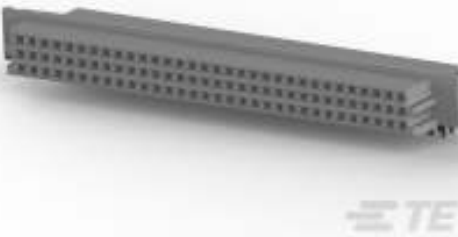
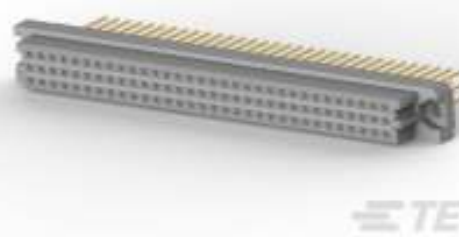
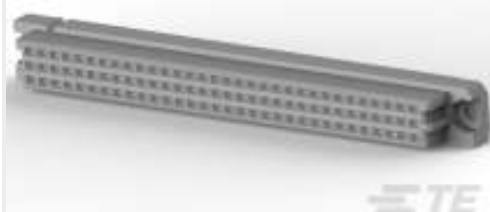
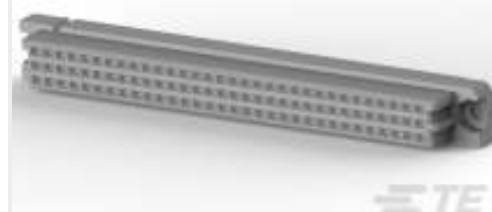
## Compatible Parts

 <p>TE Part # 925486-1 MOD. IV SNAP-IN HSG 96 POS.</p>	 <p>TE Part # 5650462-4 ASSY,RECEPTACLE,EUROCARD,TYPE</p>	 <p>TE Part # 5650461-5 ASSY,RECEPTACLE,EUROCARD,TYPE</p>	 <p>TE Part # 1-148057-5 096 EURO TYP C RECP 13MM ASSY</p>
 <p>TE Part # 5535043-5 ASSY,RECEPTACLE,EUROCARD,TYPE</p>	 <p>TE Part # 5535089-5 ASSEMBLY,RECEPTACLE,EUROCARD,TYPE</p>	 <p>TE Part # 650473-5 096 EURO TYPE C PIN ST ASSY</p>	 <p>TE Part # 5650908-5 ASSY,PIN,EUROCARD,TYPE R,LEAD-</p>



TE Part # 5536412-4  
ASSY,RECEPT,EURO,TYPE C,LEAD-FREE,96,.18



TE Part # 5650473-5  
ASSY,PIN,EUROCARD,TYPE C,LEAD-FREE,96,.18



TE Part # 5536418-5  
ASSY,RECEPT,EURO,TYPE C,LEAD-FREE,96,.18



TE Part # 650947-5  
096 EURO TYPE C PIN ST ASSY



TE Part # 5535090-4  
ASSEMBLY,RECEPTACLE,EUROCARD,TYPE C,LEAD-FREE,96,.18



TE Part # 650461-4  
096 EURO TYPE R RECPT ASSY



TE Part # 215605-4  
96P.IEC-C MALE CONN



TE Part # 535043-4  
096 EURO TYPE C RECEPT ST ASSY



TE Part # 5148059-5  
ASSY,RECEPTACLE,EUROCARD,TYPE C,LEAD-FREE,96,.18



TE Part # 5650963-4  
ASSY,RECEPTACLE,EUROCARD,TYPE C,LEAD-FREE,96,.18



TE Part # 5536405-5  
ASSY,PIN,EUROCARD,TYPE C,LEAD-FREE,96,.18



TE Part # 5650461-4  
ASSY,RECEPTACLE,EUROCARD,TYPE C,LEAD-FREE,96,.18

### Customers Also Bought



TE Part #1-1415898-8  
RTS3L005

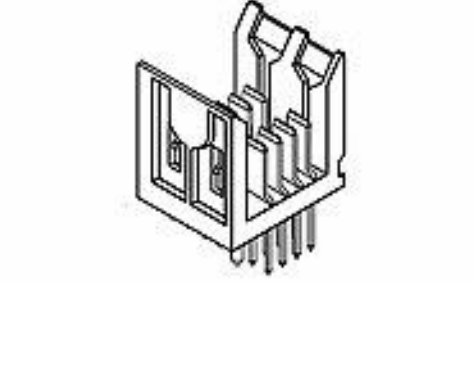

TE Part #5536600-1  
2MMFB,ASY,008,PWR,HDR,SL,4.25



TE Part #6-1393644-6  
V42254B1200B640=PC612 MESSERLE



TE Part #172331-1  
MINI UNIVERSAL MATE-N-LOK CAP HOUSING 6P



TE Part #1-2176045-6  
EP 5W 2K2 5%



TE Part #1437565-4  
FSM102=NEW P/N



TE Part #2176323-3  
SMV 2W 150K 5%



TE Part #5148057-5  
ASSY,RECEPTACLE,EUROCARD,TYPE C,LEAD-FREE,96,.18

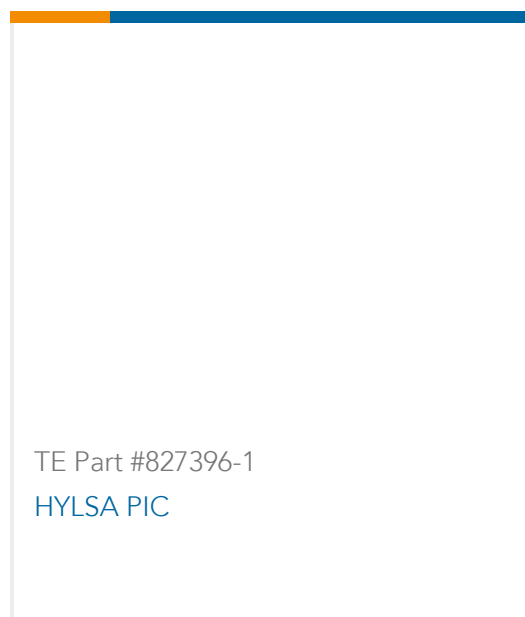

## Documents

### Product Drawings

[V42254B1200C960=PC612 MESSERLE](#)

English

### CAD Files

Customer View Model

[ENG\\_CVM\\_CVM\\_9-1393644-1\\_A.2d\\_dxf.zip](#)

English

[3D PDF](#)

3D

Customer View Model

[ENG\\_CVM\\_CVM\\_9-1393644-1\\_A.3d\\_igs.zip](#)

English

Customer View Model

[ENG\\_CVM\\_CVM\\_9-1393644-1\\_A.3d\\_stp.zip](#)

English

By downloading the CAD file I accept and agree to the [Terms and Conditions](#) of use.

### Product Specifications

[Application Specification](#)

English

### Product Environmental Compliance

[Product Compliance Document](#)

English

[Product Compliance Document](#)

English