

13000X778 series

High performance pushbutton switches • threaded bushing Ø 11.9 mm • momentary



DISTINCTIVE FEATURES

- Fully sealed, black
- Double shell case for high mechanical strength and electrical insulation
- CECC approved (CECC 96401-001)
- Highly reliable contacts
- Compact size



ELECTRICAL SPECIFICATIONS

- Max. current/voltage rating with resistive load : 4 A 28 VDC
- Minimum load : 10 mA 50 mV, 10 µA 5 VDC
When used above 300 mA 28 VDC, the gold plating is removed on contact areas and is considered only as a protection against oxidation during storage.
- Initial contact resistance : 10 mΩ max.
- Insulation resistance : 1,000 MΩ min. at 500 VDC
- Dielectric strength :
1,000 Vrms 50 Hz min. between terminals
2,000 Vrms 50 Hz min. between poles
2,000 Vrms 50 Hz min. between terminals and frame
- Contact bounce : 2 ms max.
- Electrical life :
- At 4 A 28 VDC : 10,000 cycles
- At low level (50 mV 10 mA) : 150,000 cycles

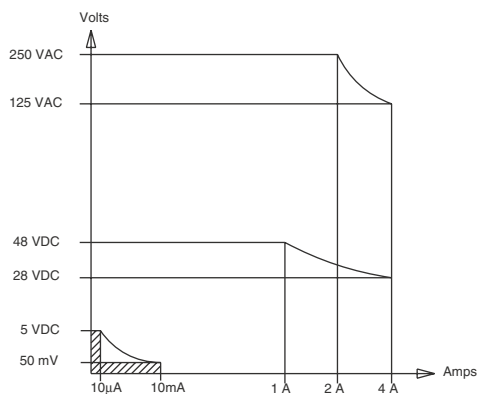

The company reserves the right to change specifications without notice.



13000X778 series

High performance pushbutton switches • threaded bushing Ø 11.9 mm • momentary



ENVIRONMENTAL SPECIFICATIONS

- Front panel sealing : IP67 according to IEC 60529
- Shock test : 50 g - 11 ms (IEC 68-2-27)
- Vibrations : 10-500 Hz - 10 g (IEC68-2-6)
- Operating temperature : -40 °C to +85 °C (-40 °F to +185 °F)
- Humidity test : 56 days, 93 % R.H., 40 °C (IEC 68-2-3)
- Salt spray test : 96 hours (IEC 68-2-11)



GENERAL SPECIFICATIONS

- Total travel : 2 mm (.078) - Pre-travel : 1 mm (.039)
- Torque : 1.50 Nm (1.10 Ft.lb) max. applied to nut
- Panel thickness : 5 mm (.196) max.



MATERIALS

- Case : diallyphthalate (DAP) with PBT external shell (epoxy sealed)
- Actuator : brass, black chrome plated
- Bushing : brass, black chrome plated
- Contacts : silver inlay - gold plated over nickel barrier

APEM products may be recycled at end-of-life for the re-claiming of valuable metal components.

AGENCY APPROVALS



CECC 96401-001

Many double pole models have full CECC approval. Consult factory for details of approved models. To order switches marked CECC, complete appropriate box of ordering format.



SEALING

- Front panel sealing by two O-rings
- Panel seal withstands 1 bar pressure and remains sealed even when the switch is operated.
- Epoxy sealed terminals
- Splash-proof case

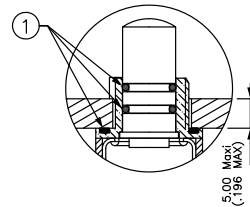

① - O-ring



TERMINALS

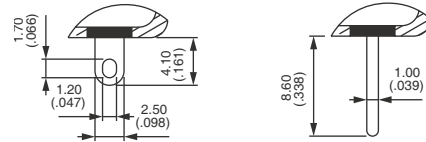

ELECTRICAL FUNCTION

→ FLAT

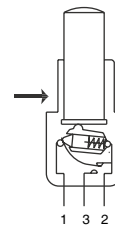

PANEL CUT-OUT

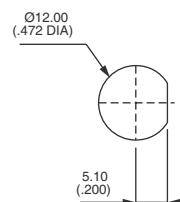



13000X778 series

High performance pushbutton switches • threaded bushing Ø 11.9 mm • momentary



POSITIONS AND CONNECTIONS

Function	BUTTON POSITION AND CONNECTIONS		TERMINAL IDENTIFICATION
	I	II	
DOUBLE POLE 13245 13445	ON	MOM	→ FLAT 
	A 1-2 B 1-2	A 1-3 B 1-3	
THREE POLE 13255 13455	A 1-2 B 1-2 C 1-2	A 1-3 B 1-3 C 1-3	

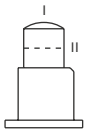

- Pre-travel : 1 mm (.039)
- Over-travel : 1 mm (.039)
- Total travel : 2 mm (.078)

13000X778 series



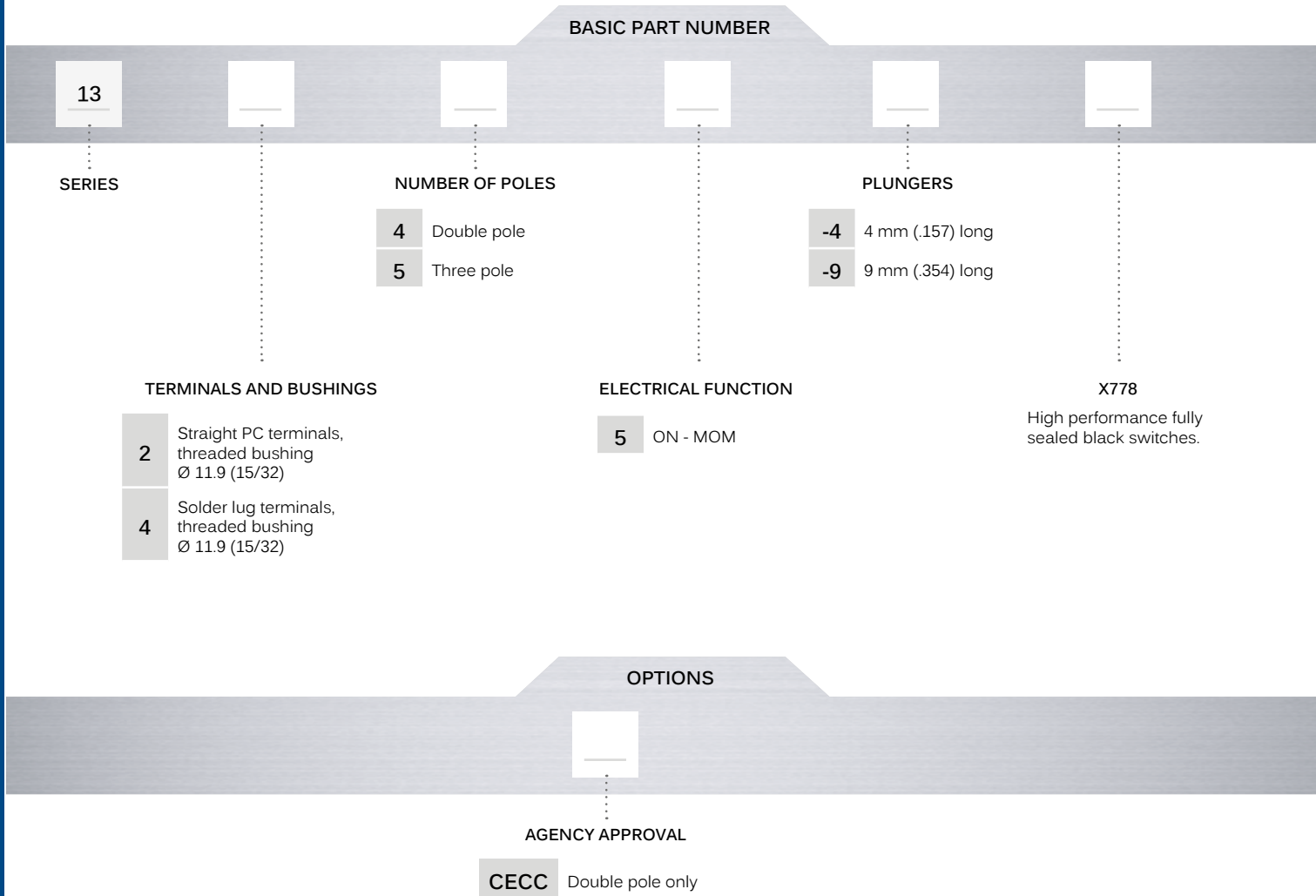

High performance pushbutton switches • threaded bushing Ø 11.9 mm • momentary

BUILD YOUR PART NUMBER



ABOUT THIS SERIES

On the following pages, you will find successively basic part numbers of switches and options in the same order as in above chart.

-  **Notice** : please note that not all combinations of above numbers are available. Refer to following pages for further information.
-  **Sealing boots** can be used to further protect the switches against dust and water. See "Sealing Boots" section of website.
-  **Mounting accessories** : standard hardware supplied with all models : 1 hex nut 14 (.551) across flats, part number U41. The nut is presented after basic models.
-  **Switch guard** available to prevent inadvertent plunger operation. See "Switch Guards" section of website.

13000X778 series

High performance pushbutton switches • threaded bushing \varnothing 11.9 mm • momentary

SOLDER LUG TERMINALS DOUBLE POLE - 4 MM (.157) PLUNGER



13445-4X778



ON



MOM

→ FLAT

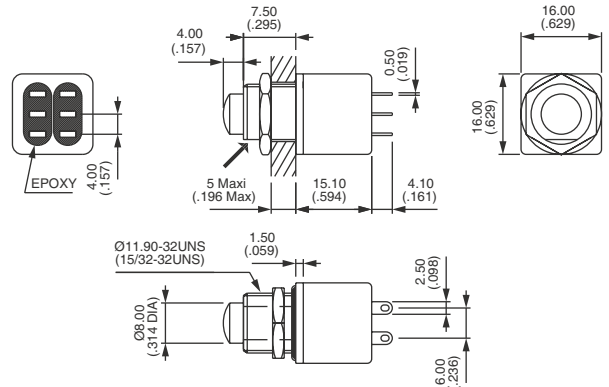

SOLDER LUG TERMINALS DOUBLE POLE - 9 MM (.354) PLUNGER



13445-9X778



ON



MOM

→ FLAT

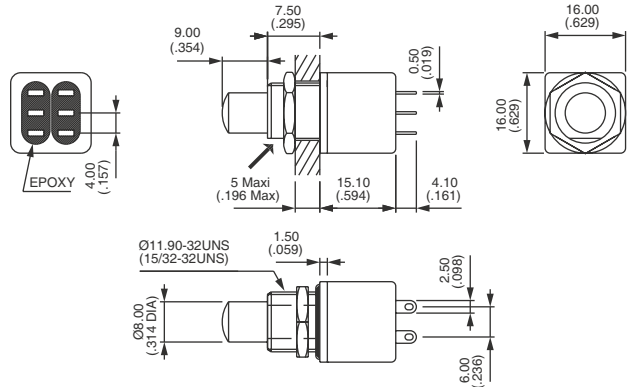

STRAIGHT PC TERMINALS DOUBLE POLE - 4 MM (.157) PLUNGER



13245-4X778



ON



MOM

→ FLAT

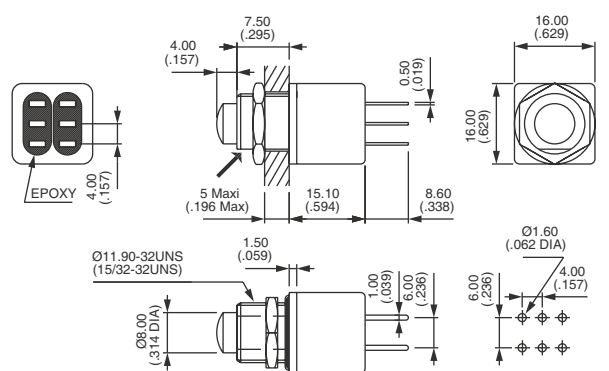

STRAIGHT PC TERMINALS DOUBLE POLE - 9 MM (.354) PLUNGER



13245-9X778



ON



MOM

→ FLAT

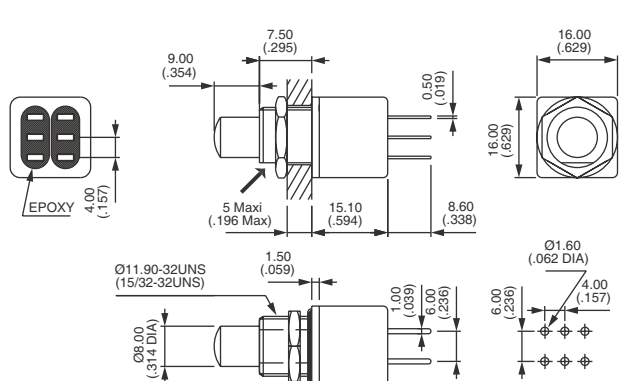

13000X778 series

High performance pushbutton switches • threaded bushing \varnothing 11.9 mm • momentary

SOLDER LUG TERMINALS THREE POLE - 4 MM (.157) PLUNGER



13455-4X778



ON



MOM

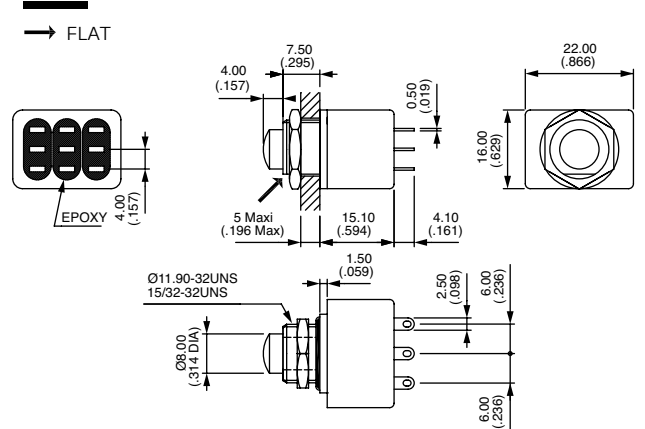

SOLDER LUG TERMINALS THREE POLE - 9 MM (.354) PLUNGER



13455-9X778



ON



MOM

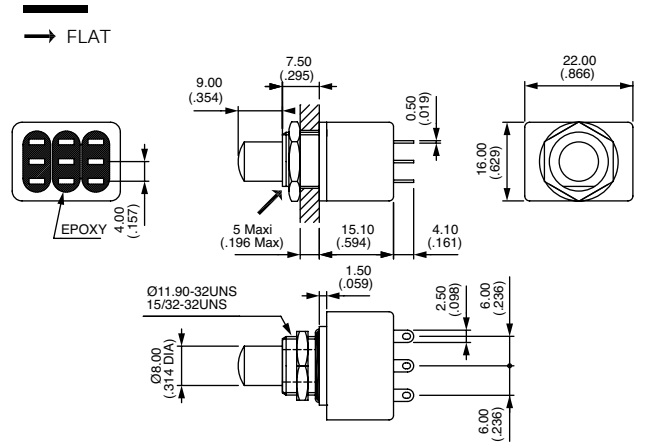

STRAIGHT PC TERMINALS THREE POLE - 4 MM (.157) PLUNGER



13255-4X778



ON



MOM

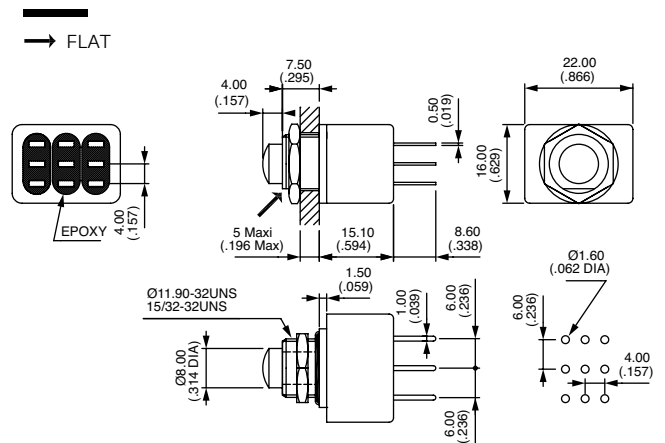

STRAIGHT PC TERMINALS THREE POLE - 9 MM (.354) PLUNGER



13255-9X778



ON



MOM

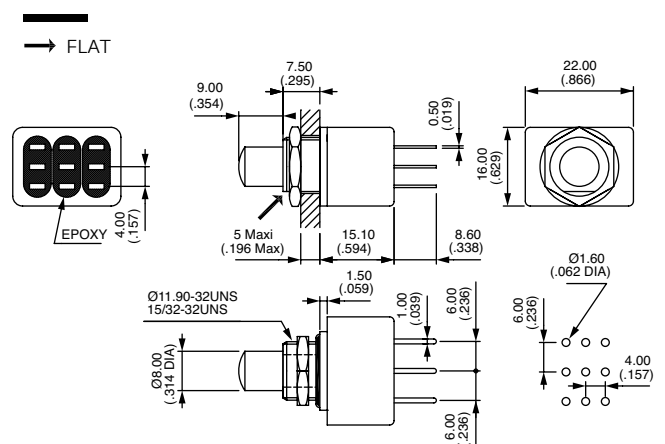

13000X778 series

High performance pushbutton switches • threaded bushing Ø 11.9 mm • momentary

STANDARD HARDWARE - HEX NUT

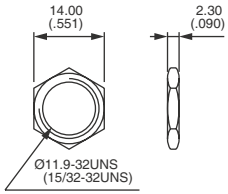

U41 (black)

AGENCY APPROVAL

BASIC P/N



CECC CECC 96401-001 (double pole only)

Blank No agency approval required.

Marking : to order switches marked CECC, please complete above box with CECC.