

WITHOUT MOUNTING EARS
6-24 CIRCUIT
46993-**11

WITH MOUNTING EARS
2-24 CIRCUIT
46993-**10

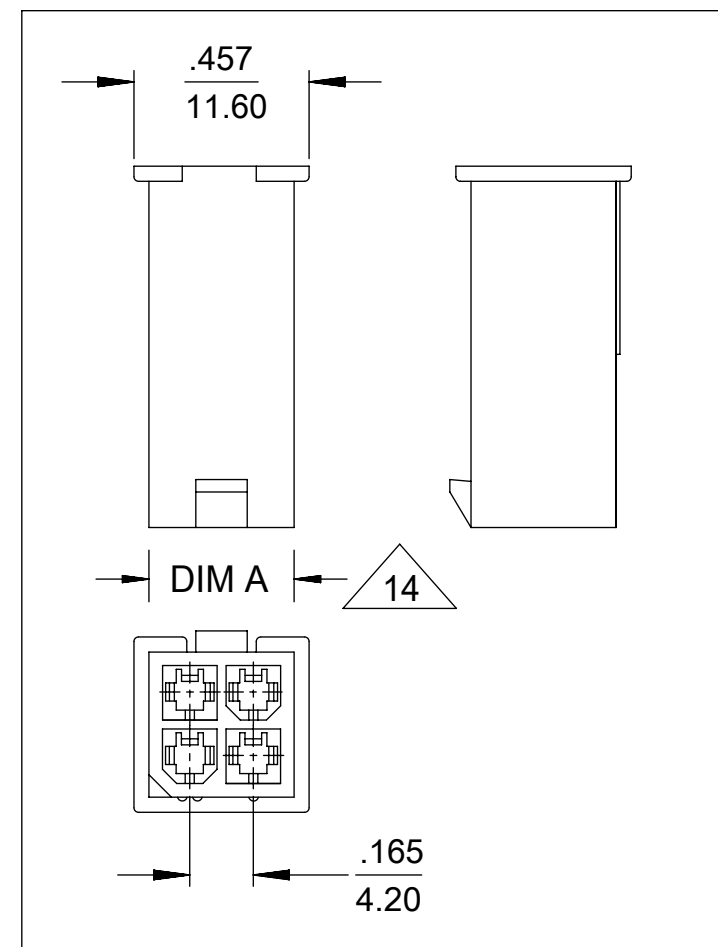

WITHOUT MOUNTING EARS
4 CIRCUIT
46993-0411
SCALE: 2X

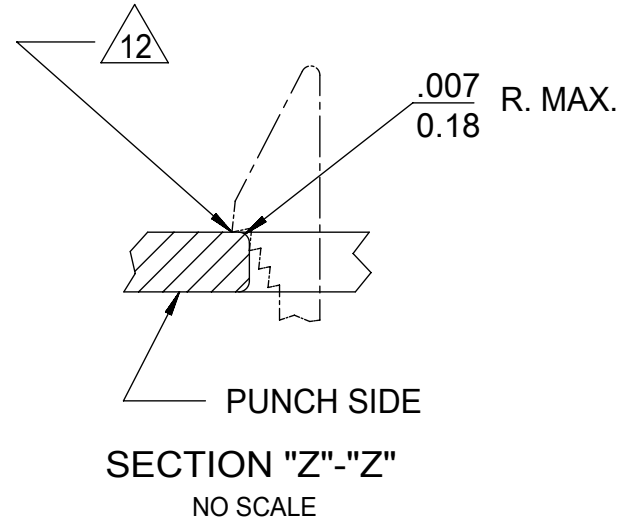
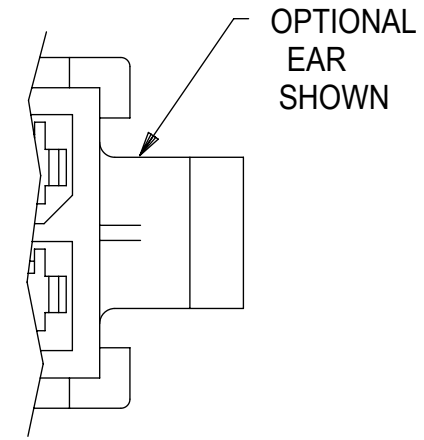
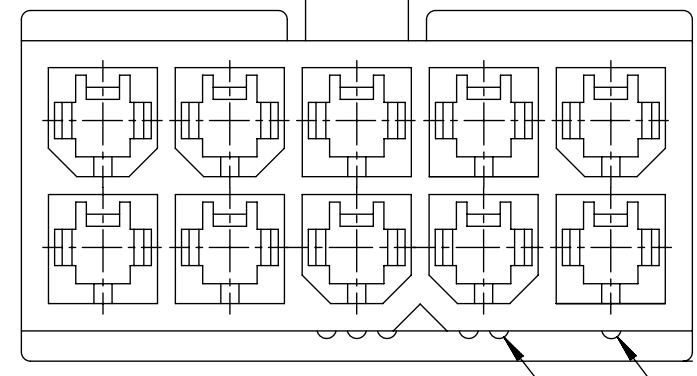
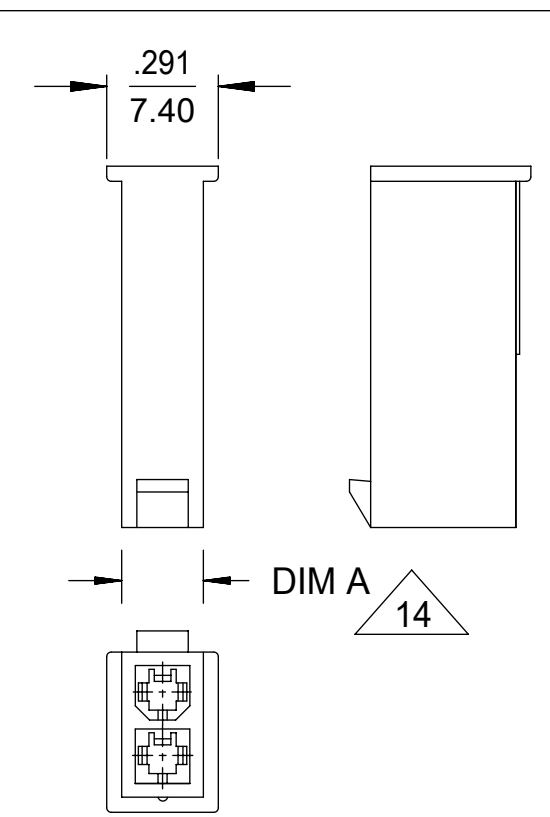

WITHOUT MOUNTING EARS
2 CIRCUIT
46993-0211
SCALE: 2X

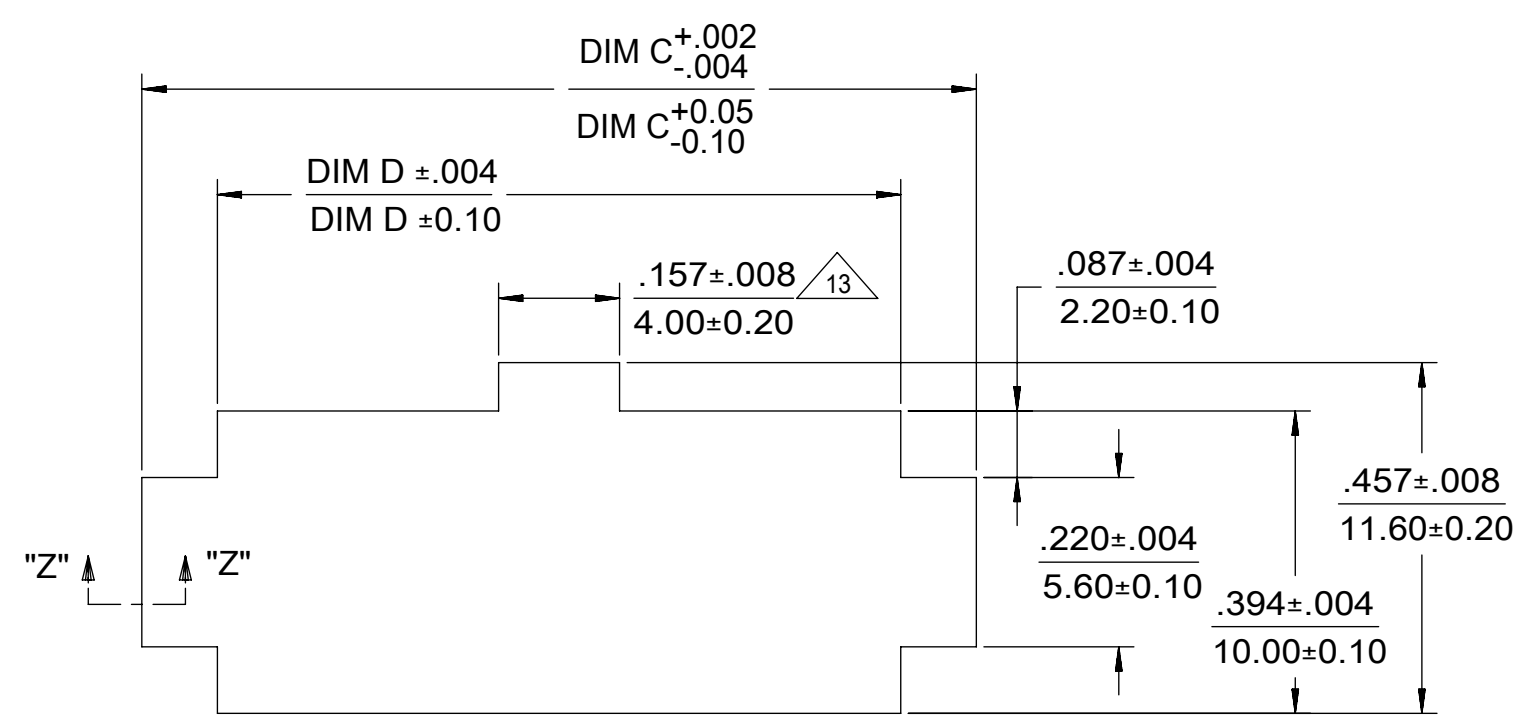

RECOMMENDED PANEL CUTOUT
THICKNESS: .032-.079 (0.80-2.00)

THIS DRAWING CONTAINS INFORMATION THAT IS PROPRIETARY TO MOLEX ELECTRONIC TECHNOLOGIES, LLC AND SHOULD NOT BE USED WITHOUT WRITTEN PERMISSION									
DIMENSION UNITS		SCALE		CURRENT REV DESC:					
mm		NTS		<p>molex</p> <p>MINI-FIT JR PLUG 2-24 CIRCUIT DUAL ROW W/ & W/O EARS GLOW WIRE</p> <p>PRODUCT CUSTOMER DRAWING</p> <p>DOCUMENT NUMBER: SD-46993-0000 DOC TYPE: PSD DOC PART: 000 REVISION: A10</p> <p>MATERIAL NUMBER: SEE TABLE CUSTOMER: GENERAL MARKET SHEET NUMBER: 1 OF 3</p>					
GENERAL TOLERANCES (UNLESS SPECIFIED)									
	MM	INCH							
4 PLACES	±	±							
3 PLACES	±	±							
2 PLACES	± 0.25	±							
1 PLACE	± 0.38	±							
0 PLACES	±	±							
ANGULAR TOL		± 0.5 °		THIRD ANGLE PROJECTION		DRAWING		SERIES	
DRAFT WHERE APPLICABLE MUST REMAIN WITHIN DIMENSIONS						C-SIZE		46993	

PART NUMBER	CKT SIZE	MOUNTING OPTION	DIM "A"	DIM "B"	DIM "C"	DIM "D"	PACKAGING SPECIFICATION	COLOR
46993-0211	02	WITHOUT EARS	.21 / 5.4	--	NOT APPLICABLE	NOT APPLICABLE	PK-5559-002	BLACK
46993-0411	04	WITHOUT EARS	.38 / 9.6	.165 / 4.20	NOT APPLICABLE	NOT APPLICABLE		
46993-0611	06	WITHOUT EARS	.54 / 13.8	.331 / 8.40	NOT APPLICABLE	NOT APPLICABLE		
46993-0811	08	WITHOUT EARS	.71 / 18.0	.496 / 12.60	NOT APPLICABLE	NOT APPLICABLE		
46993-1011	10	WITHOUT EARS	.87 / 22.2	.661 / 16.80	NOT APPLICABLE	NOT APPLICABLE		
46993-1211	12	WITHOUT EARS	1.04 / 26.4	.827 / 21.00	NOT APPLICABLE	NOT APPLICABLE		
46993-1411	14	WITHOUT EARS	1.21 / 30.6	.992 / 25.20	NOT APPLICABLE	NOT APPLICABLE		
46993-1611	16	WITHOUT EARS	1.37 / 34.8	1.158 / 29.40	NOT APPLICABLE	NOT APPLICABLE		
46993-1811	18	WITHOUT EARS	1.54 / 39.0	1.323 / 33.60	NOT APPLICABLE	NOT APPLICABLE	PK-5559-002	BLACK
46993-0210	02	WITH EARS	.21 / 5.4	--	.425 / 10.80	.228 / 5.80	PK-5559-001	BLACK
46993-0410	04	WITH EARS	.38 / 9.6	.165 / 4.20	.591 / 15.00	.394 / 10.00		
46993-0610	06	WITH EARS	.54 / 13.8	.331 / 8.40	.756 / 19.20	.559 / 14.20		
46993-0810	08	WITH EARS	.71 / 18.0	.496 / 12.60	.921 / 23.40	.724 / 18.40		
46993-1010	10	WITH EARS	.87 / 22.2	.661 / 16.80	1.087 / 27.60	.890 / 22.60		
46993-1210	12	WITH EARS	1.04 / 26.4	.827 / 21.00	1.252 / 31.80	1.055 / 26.80		
46993-1410	14	WITH EARS	1.21 / 30.6	.992 / 25.20	1.417 / 36.00	1.224 / 31.10		
46993-1610	16	WITH EARS	1.37 / 34.8	1.158 / 29.40	1.583 / 40.20	1.390 / 35.30		
46993-1810	18	WITH EARS	1.54 / 39.0	1.323 / 33.60	1.748 / 44.40	1.555 / 39.50	PK-5559-001	BLACK
46993-0201	02	WITHOUT EARS	.21 / 5.4	--	NOT APPLICABLE	NOT APPLICABLE	PK-5559-002	BEIGE
46993-0401	04	WITHOUT EARS	.38 / 9.6	.165 / 4.20	NOT APPLICABLE	NOT APPLICABLE		
46993-0601	06	WITHOUT EARS	.54 / 13.8	.331 / 8.40	NOT APPLICABLE	NOT APPLICABLE		
46993-0801	08	WITHOUT EARS	.71 / 18.0	.496 / 12.60	NOT APPLICABLE	NOT APPLICABLE		
46993-1001	10	WITHOUT EARS	.87 / 22.2	.661 / 16.80	NOT APPLICABLE	NOT APPLICABLE		
46993-1201	12	WITHOUT EARS	1.04 / 26.4	.827 / 21.00	NOT APPLICABLE	NOT APPLICABLE		
46993-1401	14	WITHOUT EARS	1.21 / 30.6	.992 / 25.20	NOT APPLICABLE	NOT APPLICABLE		
46993-1601	16	WITHOUT EARS	1.37 / 34.8	1.158 / 29.40	NOT APPLICABLE	NOT APPLICABLE		
46993-1801	18	WITHOUT EARS	1.54 / 39.0	1.323 / 33.60	NOT APPLICABLE	NOT APPLICABLE	PK-5559-002	BEIGE
46993-0200	02	WITH EARS	.21 / 5.4	--	.425 / 10.80	.228 / 5.80	PK-5559-001	BEIGE
46993-0400	04	WITH EARS	.38 / 9.6	.165 / 4.20	.591 / 15.00	.394 / 10.00		
46993-0600	06	WITH EARS	.54 / 13.8	.331 / 8.40	.756 / 19.20	.559 / 14.20		
46993-0800	08	WITH EARS	.71 / 18.0	.496 / 12.60	.921 / 23.40	.724 / 18.40		
46993-1000	10	WITH EARS	.87 / 22.2	.661 / 16.80	1.087 / 27.60	.890 / 22.60		
46993-1200	12	WITH EARS	1.04 / 26.4	.827 / 21.00	1.252 / 31.80	1.055 / 26.80		
46993-1400	14	WITH EARS	1.21 / 30.6	.992 / 25.20	1.417 / 36.00	1.224 / 31.10		
46993-1600	16	WITH EARS	1.37 / 34.8	1.158 / 29.40	1.583 / 40.20	1.390 / 35.30		
46993-1800	18	WITH EARS	1.54 / 39.0	1.323 / 33.60	1.748 / 44.40	1.555 / 39.50	PK-5559-001	BEIGE

LEGEND

46993-***0
 SERIES NUMBER
 CKT SIZE
 MATERIAL (SEE NOTE 1)
 0 = 225NS
 1 = 225S
 2 = 250RS
 3 = 250GS
 4 = 250BS
 5 = 250WS
 MOUNTING OPTION (SEE NOTE #7)

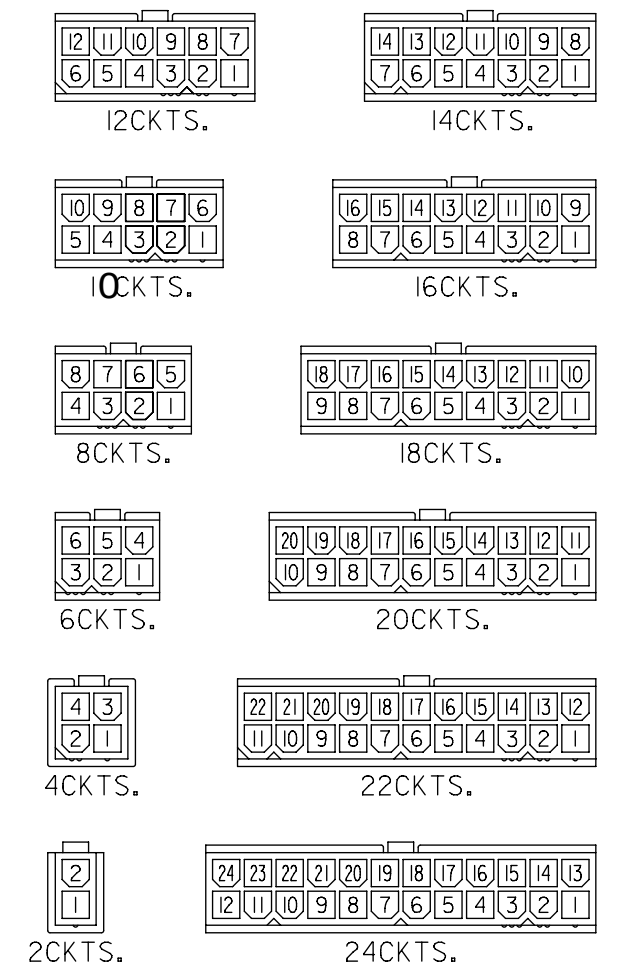

REFERENCE FOR CIRCUIT NUMBER ORIENTATION (OPTIONAL EARS NOT SHOWN)

THIS DRAWING CONTAINS INFORMATION THAT IS PROPRIETARY TO MOLEX ELECTRONIC TECHNOLOGIES, LLC AND SHOULD NOT BE USED WITHOUT WRITTEN PERMISSION									
DIMENSION UNITS		SCALE		CURRENT REV DESC:					
mm		NTS		EC NO: 745810 DRWN: JERRYW8 CHK'D: XQZHANG APPR: XQZHANG 2023/04/11 2023/04/13 2023/04/13 INITIAL REVISION: DRWN: NNGUYEN APPR: FSMITH 2013/04/11 2014/05/16					
GENERAL TOLERANCES (UNLESS SPECIFIED)									
		MM	INCH						
4 PLACES	±		±						
3 PLACES	±		±						
2 PLACES	±	0.25	±						
1 PLACE	±	0.38	±						
0 PLACES	±		±						
ANGULAR TOL		± 0.5 °		THIRD ANGLE PROJECTION		DRAWING		SERIES	
DRAFT WHERE APPLICABLE MUST REMAIN WITHIN DIMENSIONS						C-SIZE		46993	
DOCUMENT STATUS				P1		RELEASE DATE		2023/04/13 04:04:43	
DOCUMENT NUMBER				DOC TYPE		DOC PART		REVISION	
SD-46993-0000				PSD		000		A10	
MATERIAL NUMBER				CUSTOMER		SHEET NUMBER			
SEE TABLE				GENERAL MARKET		2 OF 3			

PART NUMBER	CKT SIZE	MOUNTING OPTION	DIM "A"	DIM "B"	DIM " C"	DIM"D"	PACKAGING SPECIFICATION	MATERIAL CODE & COLOR SEE NOTE 14
46993-0220	02	WITH EARS	.21 / 5.4	--	.425 / 10.80	.228 / 5.80	PK-5559-001	250RS RED (V0) 967550365
46993-0420	04	WITH EARS	.38 / 9.6	.165 / 4.20	.591 / 15.00	.394 / 10.00		
46993-0620	06	WITH EARS	.54 / 13.8	.331 / 8.40	.756 / 19.20	.559 / 14.20		
46993-0820	08	WITH EARS	.71 / 18.0	.496 / 12.60	.921 / 23.40	.724 / 18.40		
46993-1020	10	WITH EARS	.87 / 22.2	.661 / 16.80	1.087 / 27.60	.890 / 22.60		
46993-1220	12	WITH EARS	1.04 / 26.4	.827 / 21.00	1.252 / 31.80	1.055 / 26.80		
46993-0230	02	WITH EARS	.21 / 5.4	--	.425 / 10.80	.228 / 5.80	PK-5559-001	250GS GREEN (V0) 967550364
46993-0430	04	WITH EARS	.38 / 9.6	.165 / 4.20	.591 / 15.00	.394 / 10.00		
46993-0630	06	WITH EARS	.54 / 13.8	.331 / 8.40	.756 / 19.20	.559 / 14.20		
46993-0830	08	WITH EARS	.71 / 18.0	.496 / 12.60	.921 / 23.40	.724 / 18.40		
46993-1030	10	WITH EARS	.87 / 22.2	.661 / 16.80	1.087 / 27.60	.890 / 22.60		
46993-1230	12	WITH EARS	1.04 / 26.4	.827 / 21.00	1.252 / 31.80	1.055 / 26.80		
46993-0240	02	WITH EARS	.21 / 5.4	--	.425 / 10.80	.228 / 5.80	PK-5559-001	250BS BLUE (V0) 967550363
46993-0440	04	WITH EARS	.38 / 9.6	.165 / 4.20	.591 / 15.00	.394 / 10.00		
46993-0640	06	WITH EARS	.54 / 13.8	.331 / 8.40	.756 / 19.20	.559 / 14.20		
46993-0840	08	WITH EARS	.71 / 18.0	.496 / 12.60	.921 / 23.40	.724 / 18.40		
46993-1040	10	WITH EARS	.87 / 22.2	.661 / 16.80	1.087 / 27.60	.890 / 22.60		
46993-1240	12	WITH EARS	1.04 / 26.4	.827 / 21.00	1.252 / 31.80	1.055 / 26.80		
46993-0250	02	WITH EARS	.21 / 5.4	--	.425 / 10.80	.228 / 5.80	PK-5559-001	250WS NATURAL (V0)
46993-0450	04	WITH EARS	.38 / 9.6	.165 / 4.20	.591 / 15.00	.394 / 10.00		
46993-0650	06	WITH EARS	.54 / 13.8	.331 / 8.40	.756 / 19.20	.559 / 14.20		
46993-0850	08	WITH EARS	.71 / 18.0	.496 / 12.60	.921 / 23.40	.724 / 18.40		
46993-1050	10	WITH EARS	.87 / 22.2	.661 / 16.80	1.087 / 27.60	.890 / 22.60		
46993-1250	12	WITH EARS	1.04 / 26.4	.827 / 21.00	1.252 / 31.80	1.055 / 26.80		

LEGEND

46993-***0

SERIES NUMBER _____

CKT SIZE _____

MATERIAL (SEE NOTE 1)

0 = 225NS

1 = 225S

2 = 250RS

3 = 250GS

4 = 250BS

5 = 250WS

MOUNTING OPTION _____

(SEE NOTE #7)

- NOTES:
- MATERIAL:
225NS = NYLON 6, UL94V-2, GLOW WIRE, COLOR: NATURAL
225S = NYLON 6, UL94V-2, GLOW WIRE, COLOR: BLACK
250RS = NYLON 6/6, UL94V-0, GLOW WIRE, COLOR: RED
250GS = NYLON 6/6, UL94V-0, GLOW WIRE, COLOR: GREEN
250BS = NYLON 6/6, UL94V-0, GLOW WIRE, COLOR: BLUE
250WS = NYLON 6/6, UL94V-0, GLOW WIRE, COLOR: NATURAL
 - FINISH: NOT APPLICABLE
 - PRODUCT SPECIFICATION: PS-5556-001
 - PACKAGING: SEE CHART
 - PART MATES WITH MOLEX RECEPTACLE #46992.
 - PART TO BE USED WITH MOLEX MALE TERMINAL #5558.
 - MOUNTING OPTIONS:
"0" = WITH EARS, DUAL ROW
"1" = WITHOUT EARS, DUAL ROW
 - PART IS NOT DESIGNED FOR CURRENT SHARING.
 - CONNECTORS ARE NOT TO BE MATED OR UNMATED WHILE CIRCUITS ARE LIVE.
 - WIRES ARE TO BE DRESSED IN SUCH A MANNER TO ALLOW THE TERMINALS TO FLOAT FREELY IN THE POCKET.
 - PART CONFORMS TO CLASS "B" REQUIREMENTS OF COSMETIC SPECIFICATION PS-45499-002 WITH THE EXCEPTION OF DISCOLORATION, FLASH AND SINK MEET CLASS "C" REQUIREMENTS.
 - PANEL HOLE TO PUNCHED OUT IN THE SAME DIRECTION AS INSERTION INTO THE PANEL.
 - ON 2 CIRCUIT PARTS THIS DIMENSION IS ALLOWABLE UP TO DIMENSION "D".
 - TO BE MEASURED AT SURFACE **A**
 - APPLICATION SPECIFICATION :469920000-AS

THIS DRAWING CONTAINS INFORMATION THAT IS PROPRIETARY TO MOLEX ELECTRONIC TECHNOLOGIES, LLC AND SHOULD NOT BE USED WITHOUT WRITTEN PERMISSION

DIMENSION UNITS	SCALE	CURRENT REV DESC:		
mm	NTS	molex MINI-FIT JR PLUG 2-24 CIRCUIT DUAL ROW W/ & W/O EARS GLOW WIRE PRODUCT CUSTOMER DRAWING DOCUMENT NUMBER: SD-46993-0000 DOC TYPE: PSD DOC PART: 000 REVISION: A10 MATERIAL NUMBER: SEE TABLE CUSTOMER: GENERAL MARKET SHEET NUMBER: 3 OF 3		
GENERAL TOLERANCES (UNLESS SPECIFIED)				
	MM INCH			
4 PLACES	± ±			
3 PLACES	± ±			
2 PLACES	± 0.25 ±	EC NO: 745810	2023/04/11	
1 PLACE	± 0.38 ±	DRWN: JERRYW8	2023/04/13	
0 PLACES	± ±	CHK'D: XQZHANG	2023/04/13	
ANGULAR TOL	± 0.5 °	APPR: XQZHANG		
DRAFT WHERE APPLICABLE MUST REMAIN WITHIN DIMENSIONS		INITIAL REVISION:		
THIRD ANGLE PROJECTION		DRWN: NNGUYEN	2013/04/11	
DRAWING		APPR: FSMITH	2014/05/16	
SERIES		C-SIZE 46993		