

November 1996

## 1.4MHz, Low Power CMOS Operational Amplifiers

### Features

- **Wide Operating Voltage Range** . . . . .  $\pm 1\text{V}$  to  $\pm 8\text{V}$
- **High Input Impedance** . . . . .  $10^{12}\Omega$
- **Programmable Power Consumption** . . . **Low as  $20\mu\text{W}$**
- **Input Current Lower Than BIFETs** . . . . .  **$1\text{pA}$  (Typ)**
- **Output Voltage Swing** . . . . .  **$V+$  and  $V-$**
- **Input Common Mode Voltage Range Greater Than Supply Rails (ICL7612)**

### Applications

- **Portable Instruments**
- **Telephone Headsets**
- **Hearing Aid/Microphone Amplifiers**
- **Meter Amplifiers**
- **Medical Instruments**
- **High Impedance Buffers**

### Description

The ICL761X/762X/764X series is a family of monolithic CMOS operational amplifiers. These devices provide the designer with high performance operation at low supply voltages and selectable quiescent currents, and are an ideal design tool when ultra low input current and low power dissipation are desired.

The basic amplifier will operate at supply voltages ranging from  $\pm 1\text{V}$  to  $\pm 8\text{V}$ , and may be operated from a single Lithium cell.

A unique quiescent current programming pin allows setting of standby current to  $1\text{mA}$ ,  $100\mu\text{A}$ , or  $10\mu\text{A}$ , with no external components. This results in power consumption as low as  $20\mu\text{W}$ . The output swing ranges to within a few millivolts of the supply voltages.

Of particular significance is the extremely low ( $1\text{pA}$ ) input current, input noise current of  $0.01\text{pA}/\sqrt{\text{Hz}}$ , and  $10^{12}\Omega$  input impedance. These features optimize performance in very high source impedance applications.

The inputs are internally protected. Outputs are fully protected against short circuits to ground or to either supply.

AC performance is excellent, with a slew rate of  $1.6\text{V}/\mu\text{s}$ , and unity gain bandwidth of  $1\text{MHz}$  at  $I_Q = 1\text{mA}$ .

Because of the low power dissipation, junction temperature rise and drift are quite low. Applications utilizing these features may include stable instruments, extended life designs, or high density packages.

### Pinouts (See Ordering Information on Next Page)

ICL7611, ICL7612  
(PDIP, SOIC)  
TOP VIEW

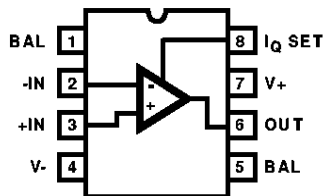

ICL7611, ICL7612  
(METAL CAN)  
TOP VIEW

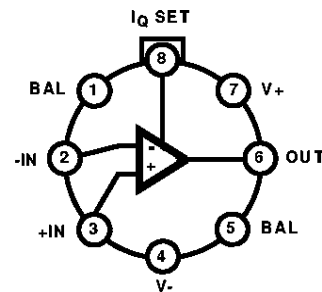

**ICL7611, ICL7612****Ordering Information**

<b>PART NUMBER</b>	<b>TEMP. RANGE (°C)</b>	<b>PACKAGE</b>	<b>PKG. NO.</b>
ICL7611ACPA	0 to 70	8 Ld PDIP - A Grade	E8.3
ICL7611BCPA	0 to 70	8 Ld PDIP - B Grade	E8.3
ICL7611DCPA	0 to 70	8 Ld PDIP - D Grade	E8.3
ICL7611ACTV	0 to 70	8 Pin Metal Can - A Grade	T8.C
ICL7611BCTV	0 to 70	8 Pin Metal Can - B Grade	T8.C
ICL7611DCTV	0 to 70	8 Pin Metal Can - D Grade	T8.C
ICL7611AMTV	-55 to 125	8 Pin Metal Can - A Grade	T8.C
ICL7611BMTV	-55 to 125	8 Pin Metal Can - B Grade	T8.C
ICL7611DMTV	-55 to 125	8 Pin Metal Can - D Grade	T8.C
ICL7611DCBA	0 to 70	8 Ld SOIC - D Grade	M8.15
ICL7611DCBA-T	0 to 70	8 Ld SOIC - D Grade - Tape and Reel	M8.15
ICL7612ACPA	0 to 70	8 Ld PDIP - A Grade	E8.3
ICL7612BCPA	0 to 70	8 Ld PDIP - B Grade	E8.3
ICL7612DCPA	0 to 70	8 Ld PDIP - D Grade	E8.3
ICL7612BCTV	0 to 70	8 Ld Metal Can - B Grade	T8.C
ICL7612DCTV	0 to 70	8 Ld Metal Can - D Grade	T8.C
ICL7612AMTV	-55 to 125	8 Ld Metal Can - A Grade	T8.C
ICL7612BMTV	-55 to 125	8 Ld Metal Can - B Grade	T8.C
ICL7612DMTV	-55 to 125	8 Ld Metal Can - D Grade	T8.C
ICL7612DCBA	0 to 70	8 Ld SOIC - D Grade	M8.15
ICL7612DCBA-T	0 to 70	8 Ld SOIC - D Grade - Tape and Reel	M8.15

# ICL7611, ICL7612

## Absolute Maximum Ratings

Supply Voltage  $V_+$  to  $V_-$  ..... 18V  
 Input Voltage .....  $V_- - 0.3$  to  $V_+ + 0.3$ V  
 Differential Input Voltage (Note 1) .....  $[(V_+ + 0.3) - (V_- - 0.3)]$ V  
 Duration of Output Short Circuit (Note 2) ..... Unlimited

## Operating Conditions

Temperature Range  
 ICL76XXM .....  $-55^\circ\text{C}$  to  $125^\circ\text{C}$   
 ICL76XXC .....  $0^\circ\text{C}$  to  $70^\circ\text{C}$

## Thermal Information

Thermal Resistance (Typical, Note 3)     $\theta_{JA}$  ( $^\circ\text{C}/\text{W}$ )     $\theta_{JC}$  ( $^\circ\text{C}/\text{W}$ )  
 PDIP Package ..... 130    N/A  
 SOIC Package ..... 170    N/A  
 Metal Can Package ..... 160    75  
 Maximum Junction Temperature (Can Package) .....  $175^\circ\text{C}$   
 Maximum Junction Temperature (Plastic Package) .....  $150^\circ\text{C}$   
 Maximum Storage Temperature .....  $-65^\circ\text{C}$  to  $150^\circ\text{C}$   
 Maximum Lead Temperature (Soldering 10s) .....  $300^\circ\text{C}$   
 (SOIC - Lead Tips Only)

**CAUTION:** Stresses above those listed in "Absolute Maximum Ratings" may cause permanent damage to the device. This is a stress only rating and operation of the device at these or any other conditions above those indicated in the operational sections of this specification is not implied.

### NOTES:

1. Long term offset voltage stability will be degraded if large input differential voltages are applied for long periods of time.
2. The outputs may be shorted to ground or to either supply, for  $V_{\text{SUPPLY}} \leq 10\text{V}$ . Care must be taken to insure that the dissipation rating is not exceeded.
3.  $\theta_{JA}$  is measured with the component mounted on an evaluation PC board in free air.

## Electrical Specifications    $V_{\text{SUPPLY}} = \pm 5\text{V}$ , Unless Otherwise Specified

PARAMETER	SYMBOL	TEST CONDITIONS	TEMP ( $^\circ\text{C}$ )	ICL7611A, ICL7612A			ICL7611B, ICL7612B			ICL7611D, ICL7612D			UNITS
				MIN	TYP	MAX	MIN	TYP	MAX	MIN	TYP	MAX	
Input Offset Voltage	$V_{OS}$	$R_S \leq 100\text{k}\Omega$	25	-	-	2	-	-	5	-	-	15	mV
			Full	-	-	3	-	-	7	-	-	20	mV
Temperature Coefficient of $V_{OS}$	$\Delta V_{OS}/\Delta T$	$R_S \leq 100\text{k}\Omega$	-	-	10	-	-	15	-	-	25	-	$\mu\text{V}/^\circ\text{C}$
Input Offset Current	$I_{OS}$		25	-	0.5	30	-	0.5	30	-	0.5	30	pA
			0 to 70	-	-	300	-	-	300	-	-	300	pA
			-55 to 125	-	-	800	-	-	800	-	-	800	pA
Input Bias Current	$I_{BIAS}$		25	-	1.0	50	-	1.0	50	-	1.0	50	pA
			0 to 70	-	-	400	-	-	400	-	-	400	pA
			-55 to 125	-	-	4000	-	-	4000	-	-	4000	pA
Common Mode Voltage Range (Except ICL7612)	$V_{CMR}$	$I_Q = 10\mu\text{A}$	25	$\pm 4.4$	-	-	$\pm 4.4$	-	-	$\pm 4.4$	-	-	V
		$I_Q = 100\mu\text{A}$	25	$\pm 4.2$	-	-	$\pm 4.2$	-	-	$\pm 4.2$	-	-	V
		$I_Q = 1\text{mA}$	25	$\pm 3.7$	-	-	$\pm 3.7$	-	-	$\pm 3.7$	-	-	V
Extended Common Mode Voltage Range (ICL7612 Only)	$V_{CMR}$	$I_Q = 10\mu\text{A}$	25	$\pm 5.3$	-	-	$\pm 5.3$	-	-	$\pm 5.3$	-	-	V
		$I_Q = 100\mu\text{A}$	25	+5.3, -5.1	-	-	+5.3, -5.1	-	-	+5.3, -5.1	-	-	V
		$I_Q = 1\text{mA}$	25	+5.3, -4.5	-	-	+5.3, -4.5	-	-	+5.3, -4.5	-	-	V
Output Voltage Swing	$V_{OUT}$	$I_Q = 10\mu\text{A}, R_L = 1\text{M}\Omega$	25	$\pm 4.9$	-	-	$\pm 4.9$	-	-	$\pm 4.9$	-	-	V
			0 to 70	$\pm 4.8$	-	-	$\pm 4.8$	-	-	$\pm 4.8$	-	-	V
			-55 to 125	$\pm 4.7$	-	-	$\pm 4.7$	-	-	$\pm 4.7$	-	-	V
		$I_Q = 100\mu\text{A}, R_L = 100\text{k}\Omega$	25	$\pm 4.9$	-	-	$\pm 4.9$	-	-	$\pm 4.9$	-	-	V
			0 to 70	$\pm 4.8$	-	-	$\pm 4.8$	-	-	$\pm 4.8$	-	-	V
			-55 to 125	$\pm 4.5$	-	-	$\pm 4.5$	-	-	$\pm 4.5$	-	-	V
		$I_Q = 1\text{mA}, R_L = 10\text{k}\Omega$	25	$\pm 4.5$	-	-	$\pm 4.5$	-	-	$\pm 4.5$	-	-	V
			0 to 70	$\pm 4.3$	-	-	$\pm 4.3$	-	-	$\pm 4.3$	-	-	V
			-55 to 125	$\pm 4.0$	-	-	$\pm 4.0$	-	-	$\pm 4.0$	-	-	V

## ICL7611, ICL7612

### Electrical Specifications $V_{SUPPLY} = \pm 5V$ , Unless Otherwise Specified (Continued)

PARAMETER	SYMBOL	TEST CONDITIONS	TEMP (°C)	ICL7611A, ICL7612A			ICL7611B, ICL7612B			ICL7611D, ICL7612D			UNITS
				MIN	TYP	MAX	MIN	TYP	MAX	MIN	TYP	MAX	
Large Signal Voltage Gain	$A_{VOL}$	$V_O = \pm 4.0V$ , $R_L = 1M\Omega$ , $I_Q = 10\mu A$	25	86	104	-	80	104	-	80	104	-	dB
			0 to 70	80	-	-	75	-	-	75	-	-	dB
			-55 to 125	74	-	-	68	-	-	68	-	-	dB
		$V_O = \pm 4.0V$ , $R_L = 100k\Omega$ , $I_Q = 100\mu A$	25	86	102	-	80	102	-	80	102	-	dB
			0 to 70	80	-	-	75	-	-	75	-	-	dB
			-55 to 125	74	-	-	68	-	-	68	-	-	dB
		$V_O = \pm 4.0V$ , $R_L = 10k\Omega$ , $I_Q = 1mA$	25	80	83	-	76	83	-	76	83	-	dB
			0 to 70	76	-	-	72	-	-	72	-	-	dB
			-55 to 125	72	-	-	68	-	-	68	-	-	dB
Unity Gain Bandwidth	GBW	$I_Q = 10\mu A$	25	-	0.044	-	-	0.044	-	-	0.044	-	MHz
		$I_Q = 100\mu A$	25	-	0.48	-	-	0.48	-	-	0.48	-	MHz
		$I_Q = 1mA$	25	-	1.4	-	-	1.4	-	-	1.4	-	MHz
Input Resistance	$R_{IN}$		25	-	$10^{12}$	-	-	$10^{12}$	-	-	$10^{12}$	-	$\Omega$
Common Mode Rejection Ratio	CMRR	$R_S \leq 100k\Omega$ , $I_Q = 10\mu A$	25	76	96	-	70	96	-	70	96	-	dB
		$R_S \leq 100k\Omega$ , $I_Q = 100\mu A$	25	76	91	-	70	91	-	70	91	-	dB
		$R_S \leq 100k\Omega$ , $I_Q = 1mA$	25	66	87	-	60	87	-	60	87	-	dB
Power Supply Rejection Ratio ( $V_{SUPPLY} = \pm 8V$ to $\pm 2V$ )	PSRR	$R_S \leq 100k\Omega$ , $I_Q = 10\mu A$	25	80	94	-	80	94	-	80	94	-	dB
		$R_S \leq 100k\Omega$ , $I_Q = 100\mu A$	25	80	86	-	80	86	-	80	86	-	dB
		$R_S \leq 100k\Omega$ , $I_Q = 1mA$	25	70	77	-	70	77	-	70	77	-	dB
Input Referred Noise Voltage	$e_N$	$R_S = 100\Omega$ , $f = 1kHz$	25	-	100	-	-	100	-	-	100	-	$nV/\sqrt{Hz}$
Input Referred Noise Current	$i_N$	$R_S = 100\Omega$ , $f = 1kHz$	25	-	0.01	-	-	0.01	-	-	0.01	-	$pA/\sqrt{Hz}$
Supply Current (No Signal, No Load)	$I_{SUPPLY}$	$I_Q SET = +5V$ , Low Bias	25	-	0.01	0.02	-	0.01	0.02	-	0.01	0.02	mA
		$I_Q SET = 0V$ , Medium Bias	25	-	0.1	0.25	-	0.1	0.25	-	0.1	0.25	mA
		$I_Q SET = -5V$ , High Bias	25	-	1.0	2.5	-	1.0	2.5	-	1.0	2.5	mA
Channel Separation	$V_{O1}/V_{O2}$	$A_V = 100$	25	-	120	-	-	120	-	-	120	-	dB
Slew Rate ( $A_V = 1$ , $C_L = 100pF$ , $V_{IN} = 8V_{P-P}$ )	SR	$I_Q = 10\mu A$ , $R_L = 1M\Omega$	25	-	0.016	-	-	0.016	-	-	0.016	-	$V/\mu s$
		$I_Q = 100\mu A$ , $R_L = 100k\Omega$	25	-	0.16	-	-	0.16	-	-	0.16	-	$V/\mu s$
		$I_Q = 1mA$ , $R_L = 10k\Omega$	25	-	1.6	-	-	1.6	-	-	1.6	-	$V/\mu s$
Rise Time ( $V_{IN} = 50mV$ , $C_L = 100pF$ )	$t_R$	$I_Q = 10\mu A$ , $R_L = 1M\Omega$	25	-	20	-	-	20	-	-	20	-	$\mu s$
		$I_Q = 100\mu A$ , $R_L = 100k\Omega$	25	-	2	-	-	2	-	-	2	-	$\mu s$
		$I_Q = 1mA$ , $R_L = 10k\Omega$	25	-	0.9	-	-	0.9	-	-	0.9	-	$\mu s$
Overshoot Factor ( $V_{IN} = 50mV$ , $C_L = 100pF$ )	OS	$I_Q = 10\mu A$ , $R_L = 1M\Omega$	25	-	5	-	-	5	-	-	5	-	%
		$I_Q = 100\mu A$ , $R_L = 100k\Omega$	25	-	10	-	-	10	-	-	10	-	%
		$I_Q = 1mA$ , $R_L = 10k\Omega$	25	-	40	-	-	40	-	-	40	-	%

## ICL7611, ICL7612

### Electrical Specifications $V_{SUPPLY} = \pm 1V$ , $I_Q = 10\mu A$ , Unless Otherwise Specified

PARAMETER	SYMBOL	TEST CONDITIONS	TEMP (°C)	ICL7611A, ICL7612A			ICL7611B, ICL7612B			UNITS
				MIN	TYP	MAX	MIN	TYP	MAX	
Input Offset Voltage	$V_{OS}$	$R_S \leq 100k\Omega$	25	-	-	2	-	-	5	mV
			Full	-	-	3	-	-	7	mV
Temperature Coefficient of $V_{OS}$	$\Delta V_{OS}/\Delta T$	$R_S \leq 100k\Omega$	-	-	10	-	-	15	-	$\mu V/^\circ C$
Input Offset Current	$I_{OS}$		25	-	0.5	30	-	0.5	30	pA
			0 to 70	-	-	300	-	-	300	pA
Input Bias Current	$I_{BIAS}$		25	-	1.0	50	-	1.0	50	pA
			0 to 70	-	-	500	-	-	500	pA
Common Mode Voltage Range (Except ICL7612)	$V_{CMR}$		25	$\pm 0.6$	-	-	$\pm 0.6$	-	-	V
Extended Common Mode Voltage Range (ICL7612 Only)	$V_{CMR}$		25	+0.6 to -1.1	-	-	+0.6 to -1.1	-	-	V
Output Voltage Swing	$V_{OUT}$	$R_L = 1M\Omega$	25	$\pm 0.98$	-	-	$\pm 0.98$	-	-	V
			0 to 70	$\pm 0.96$	-	-	$\pm 0.96$	-	-	V
Large Signal Voltage Gain	$A_{VOL}$	$V_O = \pm 0.1V$ , $R_L = 1M\Omega$	25	-	90	-	-	90	-	dB
			0 to 70	-	80	-	-	80	-	dB
Unity Gain Bandwidth	GBW		25	-	0.044	-	-	0.044	-	MHz
Input Resistance	$R_{IN}$		25	-	$10^{12}$	-	-	$10^{12}$	-	$\Omega$
Common Mode Rejection Ratio	CMRR	$R_S \leq 100k\Omega$	25	-	80	-	-	80	-	dB
Power Supply Rejection Ratio	PSRR	$R_S \leq 100k\Omega$	25	-	80	-	-	80	-	dB
Input Referred Noise Voltage	$e_N$	$R_S = 100\Omega$ , $f = 1kHz$	25	-	100	-	-	100	-	$nV/\sqrt{Hz}$
Input Referred Noise Current	$i_N$	$R_S = 100\Omega$ , $f = 1kHz$	25	-	0.01	-	-	0.01	-	$pA/\sqrt{Hz}$
Supply Current	$I_{SUPPLY}$	No Signal, No Load	25	-	6	15	-	6	15	$\mu A$
Slew Rate	SR	$A_V = 1$ , $C_L = 100pF$ , $V_{IN} = 0.2V_{P-P}$ , $R_L = 1M\Omega$	25	-	0.016	-	-	0.016	-	$V/\mu s$
Rise Time	$t_R$	$V_{IN} = 50mV$ , $C_L = 100pF$ , $R_L = 1M\Omega$	25	-	20	-	-	20	-	$\mu s$
Overshoot Factor	OS	$V_{IN} = 50mV$ , $C_L = 100pF$ , $R_L = 1M\Omega$	25	-	5	-	-	5	-	%

**Schematic Diagram**

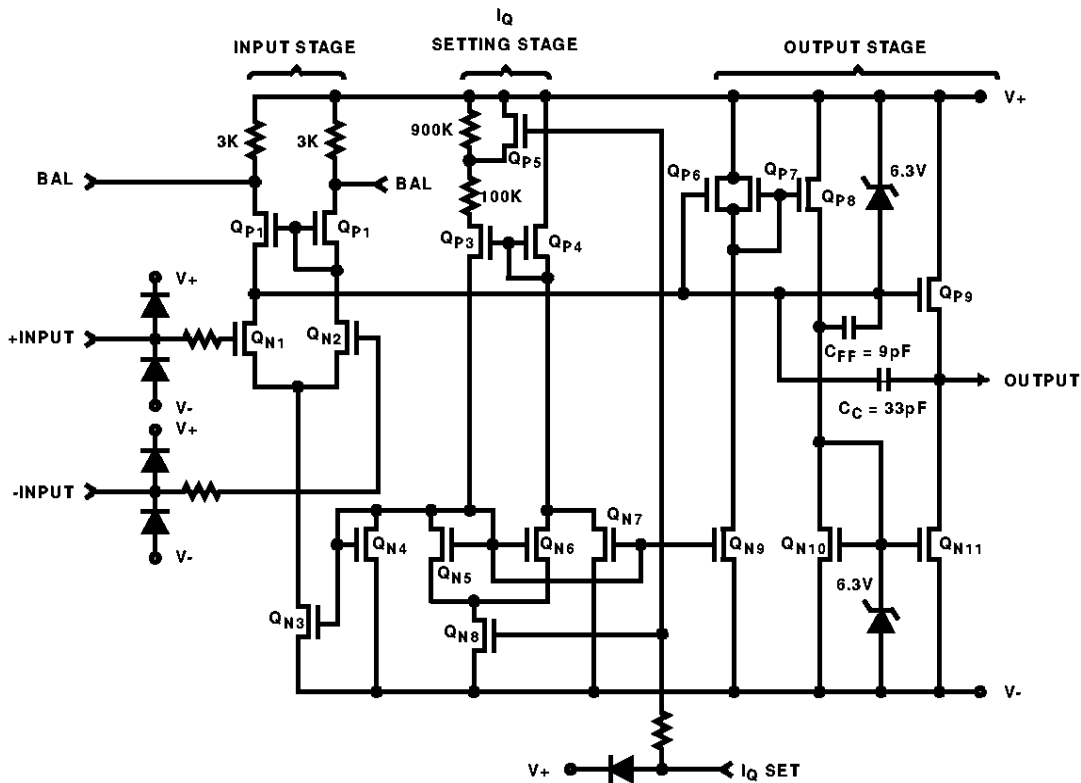

**Application Information**

**Static Protection**

All devices are static protected by the use of input diodes. However, strong static fields should be avoided, as it is possible for the strong fields to cause degraded diode junction characteristics, which may result in increased input leakage currents.

**Latchup Avoidance**

Junction-isolated CMOS circuits employ configurations which produce a parasitic 4-layer (PNPN) structure. The 4-layer structure has characteristics similar to an SCR, and under certain circumstances may be triggered into a low impedance state resulting in excessive supply current. To avoid this condition, no voltage greater than 0.3V beyond the supply rails may be applied to any pin. In general, the op amp supplies must be established simultaneously with, or before any input signals are applied. If this is not possible, the drive circuits must limit input current flow to 2mA to prevent latchup.

**Choosing the Proper I<sub>Q</sub>**

The ICL7611 and ICL7612 have a similar I<sub>Q</sub> set-up scheme, which allows the amplifier to be set to nominal quiescent currents of 10μA, 100μA or 1mA. These current settings change only very slightly over the entire supply voltage

range. The ICL7611/12 have an external I<sub>Q</sub> control terminal, permitting user selection of quiescent current. To set the I<sub>Q</sub> connect the I<sub>Q</sub> terminal as follows:

I<sub>Q</sub> = 10μA - I<sub>Q</sub> pin to V+

I<sub>Q</sub> = 100μA - I<sub>Q</sub> pin to ground. If this is not possible, any voltage from V+ - 0.8 to V- +0.8 can be used.

I<sub>Q</sub> = 1mA - I<sub>Q</sub> pin to V-

NOTE: The output current available is a function of the quiescent current setting. For maximum peak-to-peak output voltage swings into low impedance loads, I<sub>Q</sub> of 1mA should be selected.

**Output Stage and Load Driving Considerations**

Each amplifiers' quiescent current flows primarily in the output stage. This is approximately 70% of the I<sub>Q</sub> settings. This allows output swings to almost the supply rails for output loads of 1MΩ, 100kΩ, and 10kΩ, using the output stage in a highly linear class A mode. In this mode, crossover distortion is avoided and the voltage gain is maximized. However, the output stage can also be operated in Class AB for higher output currents. (See graphs under Typical Operating Characteristics). During the transition from Class A to Class B operation, the output transfer characteristic is non-linear and the voltage gain decreases.

**Input Offset Nulling**

Offset nulling may be achieved by connecting a 25K pot between the BAL terminals with the wiper connected to V+. At quiescent currents of 1mA and 100µA the nulling range provided is adequate for all V<sub>OS</sub> selections; however with I<sub>Q</sub> = 10µA, nulling may not be possible with higher values of V<sub>OS</sub>.

**Frequency Compensation**

The ICL7611 and ICL7612 are internally compensated, and are stable for closed loop gains as low as unity with capacitive loads up to 100pF.

**Extended Common Mode Input Range**

The ICL7612 incorporates additional processing which allows the input CMVR to exceed each power supply rail by 0.1V for applications where V<sub>SUPP</sub> ≥ ±1.5V. For those applications where V<sub>SUPP</sub> ≤ ±1.5V the input CMVR is limited in the positive direction, but may exceed the negative supply rail by 0.1V in the negative direction (e.g., for V<sub>SUPPLY</sub> = ±1V, the input CMVR would be +0.6V to -1.1V).

**Operation At V<sub>SUPPLY</sub> = ±1V**

Operation at V<sub>SUPPLY</sub> = ±1V is guaranteed at I<sub>Q</sub> = 10µA for A and B grades only.

Output swings to within a few millivolts of the supply rails are achievable for R<sub>L</sub> ≥ 1MΩ. Guaranteed input CMVR is ±0.6V minimum and typically +0.9V to -0.7V at V<sub>SUPPLY</sub> = ±1V. For applications where greater common mode range is desirable, refer to the description of ICL7612 above.

**Typical Applications**

The user is cautioned that, due to extremely high input impedances, care must be exercised in layout, construction, board cleanliness, and supply filtering to avoid hum and noise pickup.

Note that in no case is I<sub>Q</sub> shown. The value of I<sub>Q</sub> must be chosen by the designer with regard to frequency response and power dissipation.

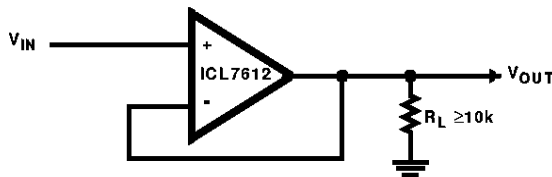
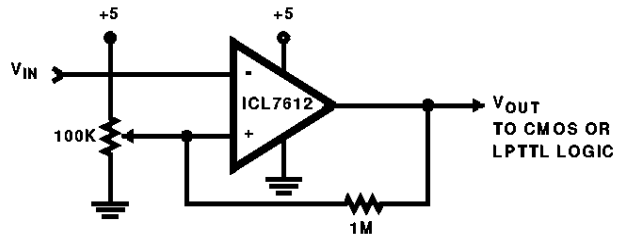

FIGURE 1. SIMPLE FOLLOWER (NOTE 4)



NOTE:

- 4. By using the ICL7612 in this application, the circuit will follow rail to rail inputs.

FIGURE 2. LEVEL DETECTOR (NOTE 4)

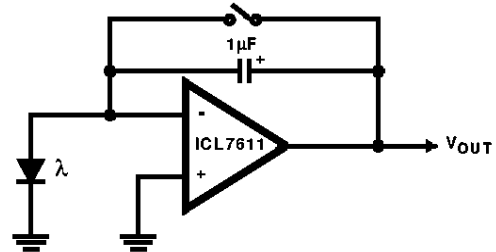

NOTE: Low leakage currents allow integration times up to several hours.

FIGURE 3. PHOTOCURRENT INTEGRATOR

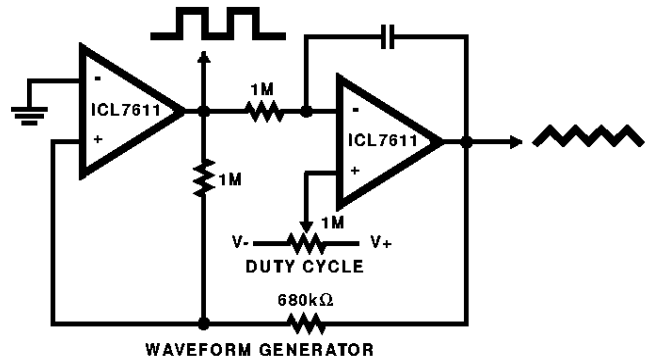

NOTE: Since the output range swings exactly from rail to rail, frequency and duty cycle are virtually independent of power supply variations.

FIGURE 4. PRECISE TRIANGLE/SQUARE WAVE GENERATOR

## ICL7611, ICL7612

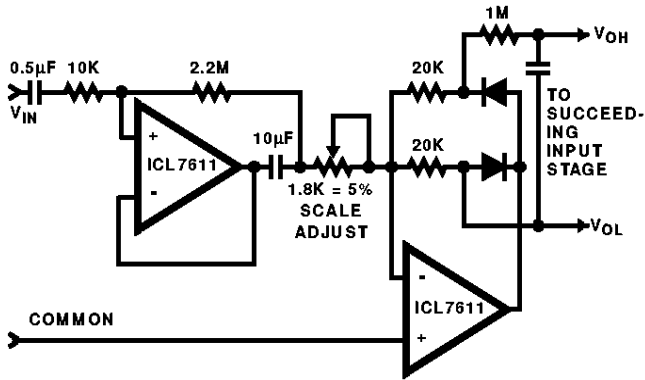

FIGURE 5. AVERAGING AC TO DC CONVERTER FOR A/D CONVERTERS SUCH AS ICL7106, ICL7107, ICL7109, ICL7116, ICL7117

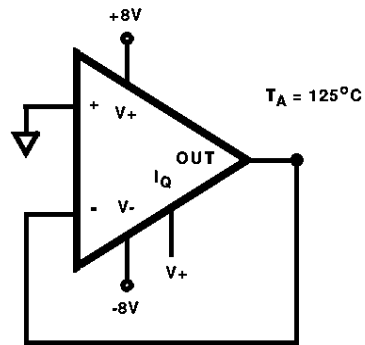

FIGURE 6. BURN-IN AND LIFE TEST CIRCUIT

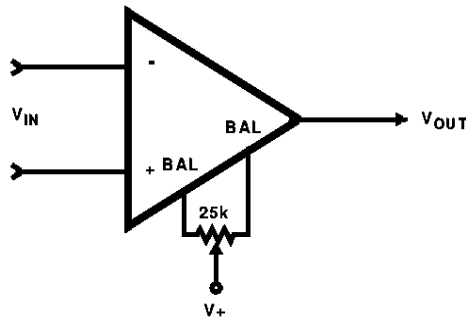
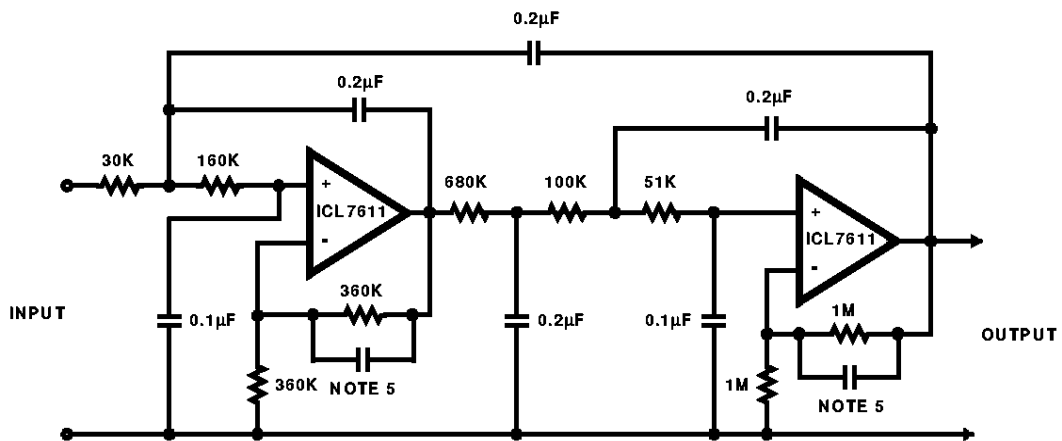

FIGURE 7.  $V_{OS}$  NULL CIRCUIT



**NOTES:**

5. Note that small capacitors (25pF to 50pF) may be needed for stability in some cases.
6. The low bias currents permit high resistance and low capacitance values to be used to achieve low frequency cutoff.  $f_C = 10\text{Hz}$ ,  $A_{VCL} = 4$ , Passband ripple = 0.1dB.

FIGURE 8. FIFTH ORDER CHEBYCHEV MULTIPLE FEEDBACK LOW PASS FILTER



Typical Performance Curves

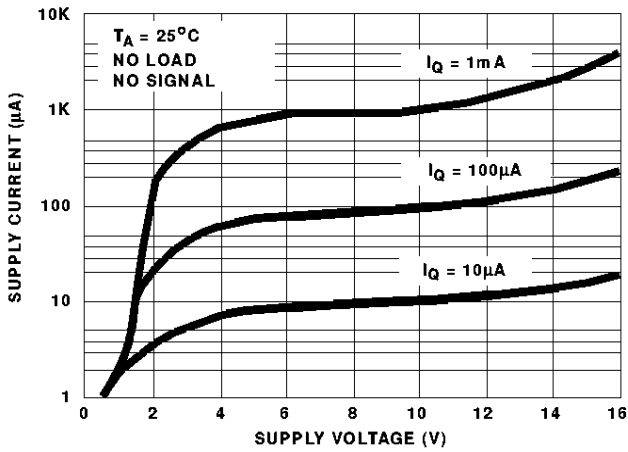

FIGURE 9. SUPPLY CURRENT PER AMPLIFIER vs SUPPLY VOLTAGE

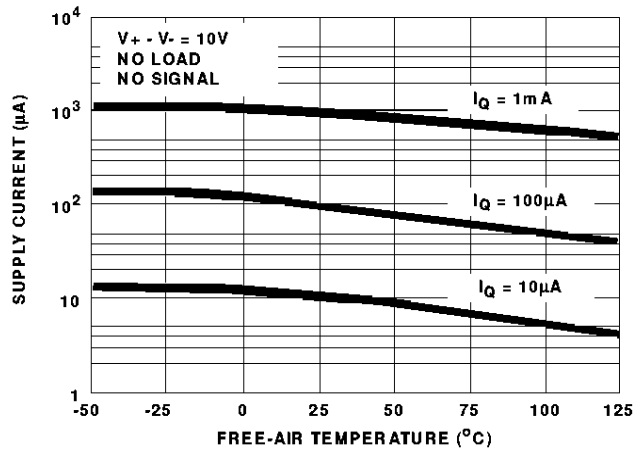

FIGURE 10. SUPPLY CURRENT PER AMPLIFIER vs FREE-AIR TEMPERATURE

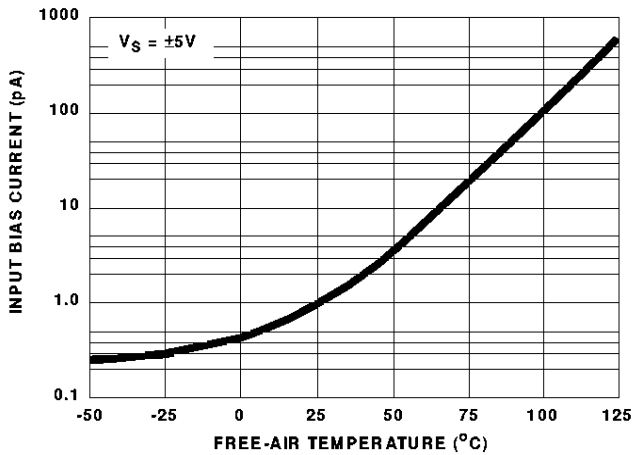

FIGURE 11. INPUT BIAS CURRENT vs TEMPERATURE

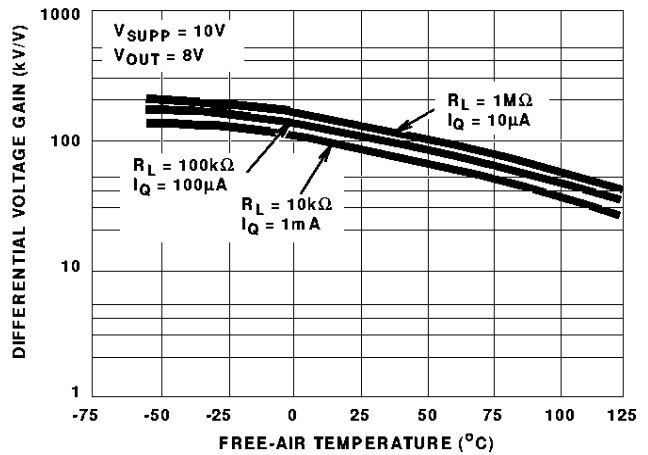

FIGURE 12. LARGE SIGNAL DIFFERENTIAL VOLTAGE GAIN vs FREE-AIR TEMPERATURE

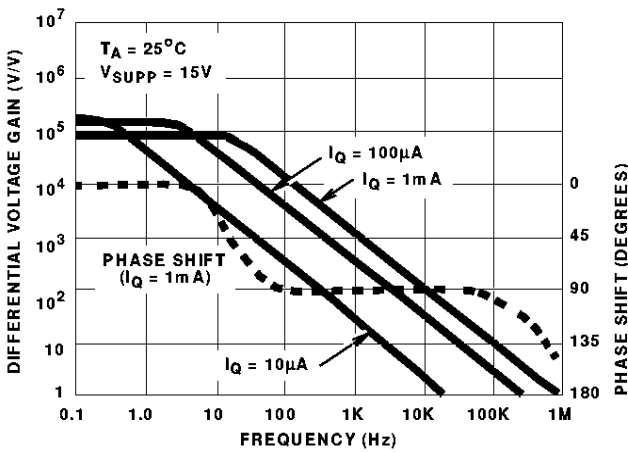

FIGURE 13. LARGE SIGNAL FREQUENCY RESPONSE

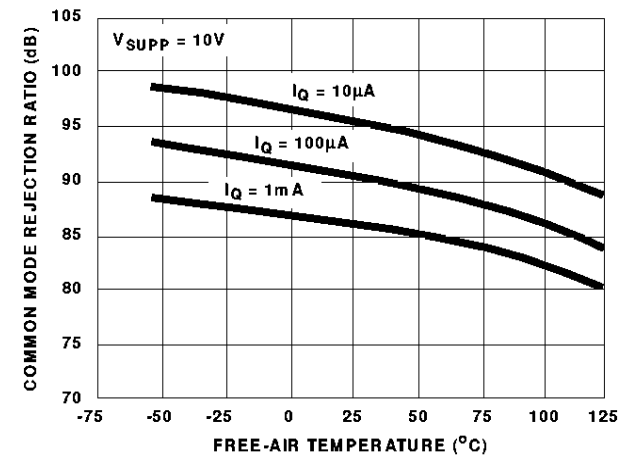

FIGURE 14. COMMON MODE REJECTION RATIO vs FREE-AIR TEMPERATURE

Typical Performance Curves (Continued)

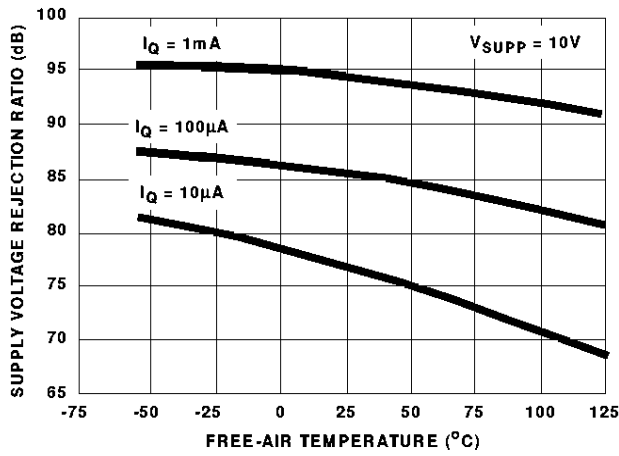

FIGURE 15. POWER SUPPLY REJECTION RATIO vs FREE-AIR TEMPERATURE

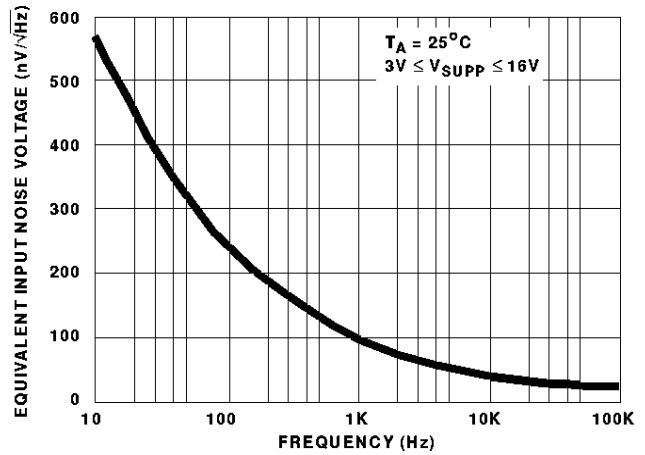

FIGURE 16. EQUIVALENT INPUT NOISE VOLTAGE vs FREQUENCY

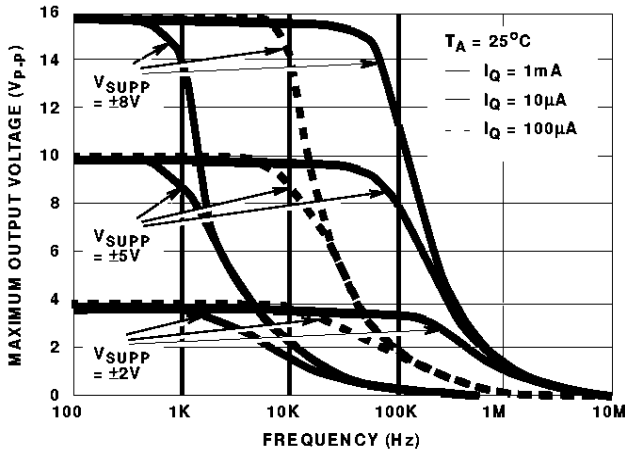

FIGURE 17. OUTPUT VOLTAGE vs FREQUENCY

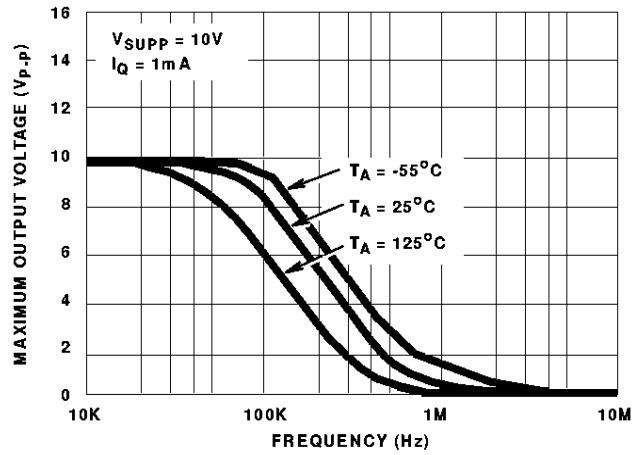

FIGURE 18. OUTPUT VOLTAGE vs FREQUENCY

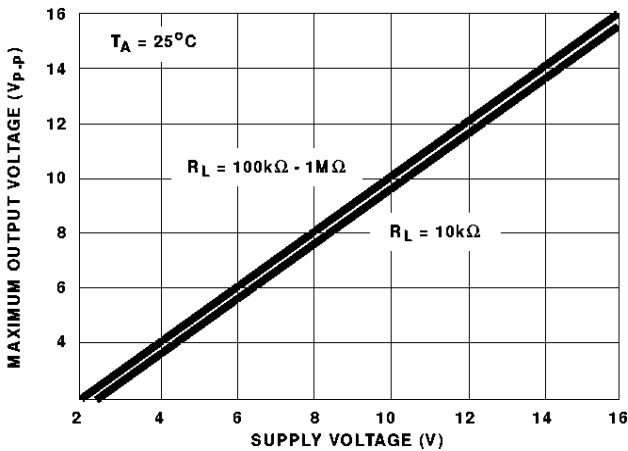

FIGURE 19. OUTPUT VOLTAGE vs SUPPLY VOLTAGE

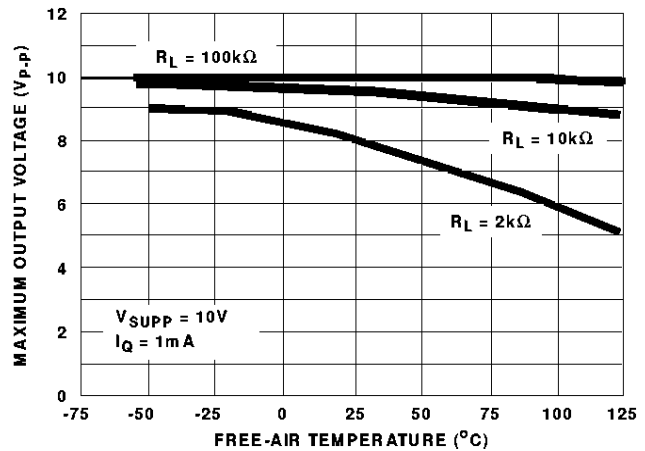

FIGURE 20. OUTPUT VOLTAGE vs FREE-AIR TEMPERATURE

Typical Performance Curves (Continued)

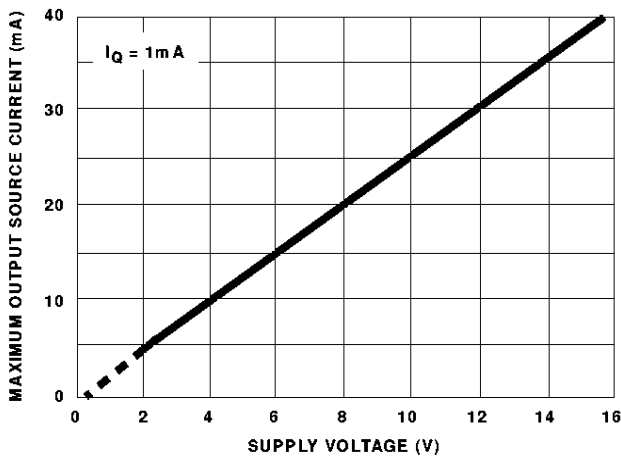

FIGURE 21. OUTPUT SOURCE CURRENT vs SUPPLY VOLTAGE

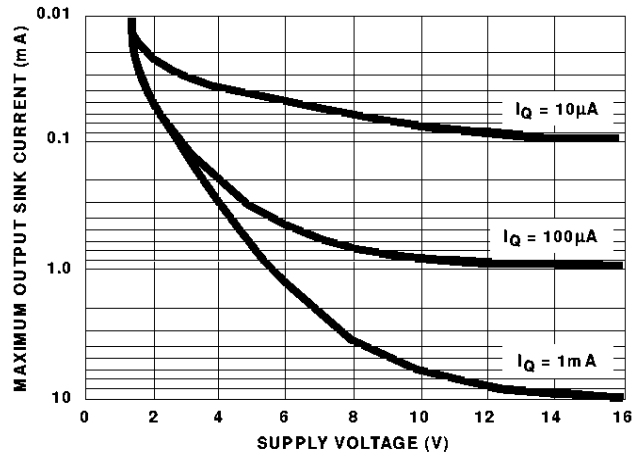

FIGURE 22. OUTPUT SINK CURRENT vs SUPPLY VOLTAGE

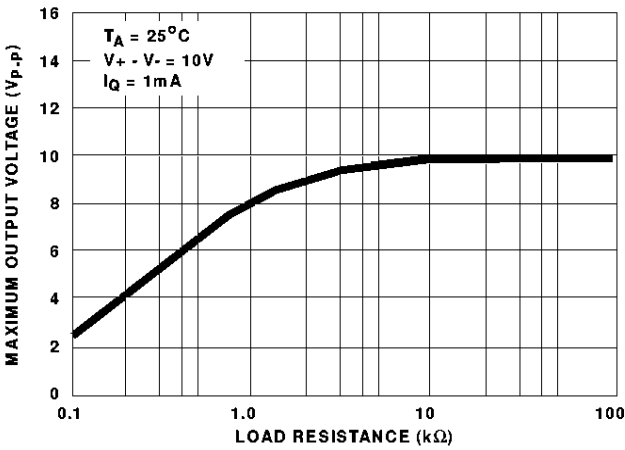

FIGURE 23. OUTPUT VOLTAGE vs LOAD RESISTANCE

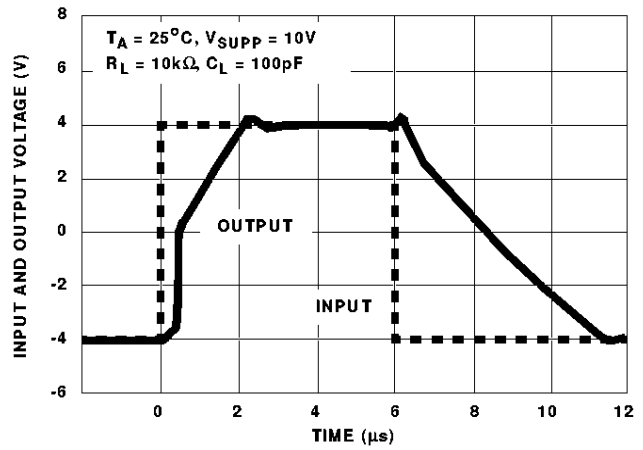

FIGURE 24. VOLTAGE FOLLOWER LARGE SIGNAL PULSE RESPONSE ( $I_Q = 1\text{mA}$ )

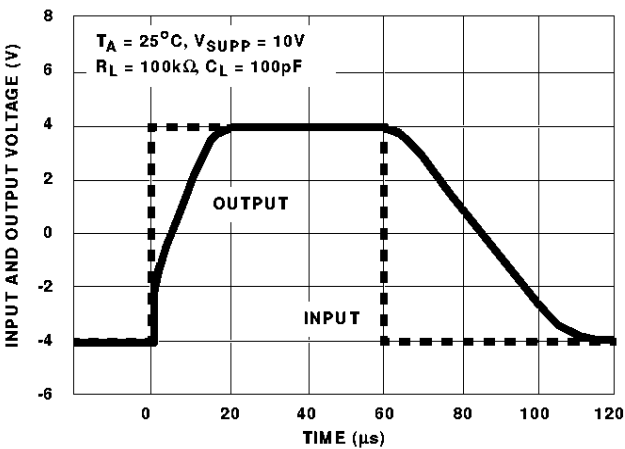

FIGURE 25. VOLTAGE FOLLOWER LARGE SIGNAL PULSE RESPONSE ( $I_Q = 100\mu\text{A}$ )

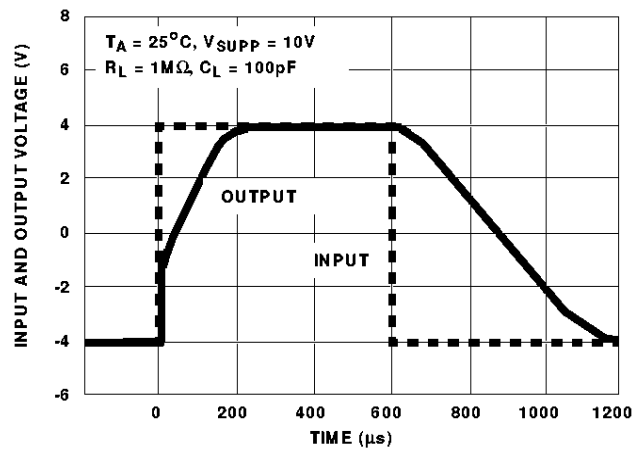

FIGURE 26. VOLTAGE FOLLOWER LARGE SIGNAL PULSE RESPONSE ( $I_Q = 10\mu\text{A}$ )