

Two-stage performance filter

FN 670

- Current ratings from 1.8 to 10A
- Very high differential and common mode attenuation
- Good high frequency attenuation
- Nennströme von 1,8 bis 10A
- Sehr hohe differentielle und Gleichtakt-Dämpfung
- Gute Hochfrequenzdämpfung
- Courants de service de 1,8 à 10A
- Très bonne atténuation en modes différentiel et commun
- Bonne atténuation à des hautes fréquences



Filter selection table

Choose the family FN xxx with the required current rating and features, and add /?? to determine input/output (line/load) connection style. Example: FN 670-3/06 is a 3A filter with fast-on connections.

Approvals



Family	Connections		Current ratings at 40°C (25°) A	Inductance L/L1 mH	Housing	Weight g	
	/06	/07				/06	/07
FN 670 -1.8 /??	/06	/07	1.6 (1.8)	7.2/7.2	K2	225	240
FN 670 -3 /??	/06	/07	2.5 (3)	12.2/1.8	K2	240	245
FN 670 -6 /??	/06	/07	5 (6)	7/7	K2	245	260
FN 670 -10 /??	/06	/07	8.0 (10)	10.4/2.7	L1	570	620

Additional specifications

Filter type	Capacitance		Res. R MΩ	Maximum leakage μA/phase	Maximum operating voltage		Operating frequency Hz	Hipot test voltage	
	Cx/Cx1 nF	Cy nF			VAC	Hz		PN→E VAC	P→N VAC
Standard types	470/150	2.2	0.47	190	250	50/60	DC to 400	2000	1700

MTBF at 40°C, 230V, per Mil-HB-217F: 300,000 hours (for VDE-approved current ratings).

FN 670 insertion loss

Per CISPR 17; A = 50Ω/50Ω sym, B = 50Ω/50Ω asym, C = 0.1Ω/100Ω sym, D = 100Ω/0.1Ω sym

1.8 amp types

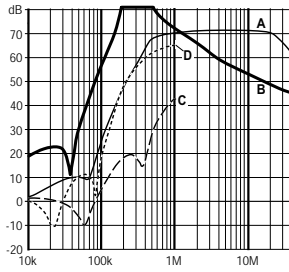

3 amp types

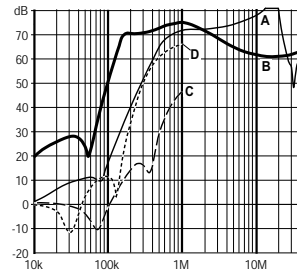

6 amp types

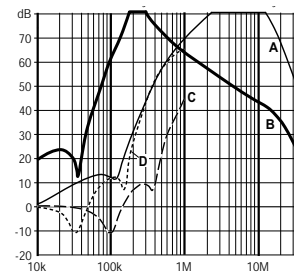

10 amp types

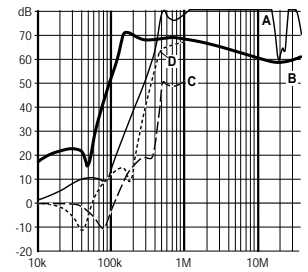

Electrical schematic

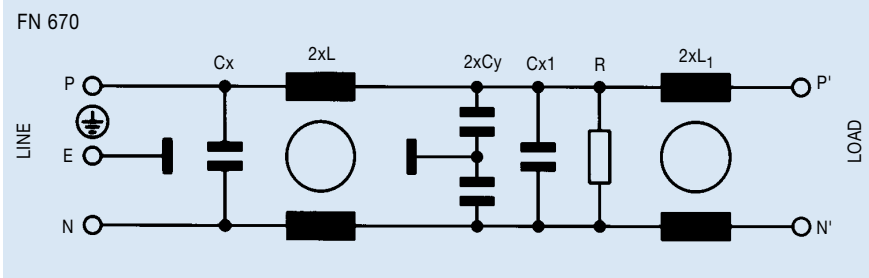

See tables for component values.

Mechanical data

	FN 670-1.8 /-3/-6	FN 670-10	Tol.* mm
A	85	105	± 0.5
B	54	99.5 ± 1	± 0.5
C	40	38	± 1
D	65	84.5	± 1
E		79	± 0.5
F	75	95	± 0.2
G		51	± 0.1
J	27	40	± 0.5
K	12	9.5	± 0.5
L	29.5	19	± 0.5
M	5.3	4.4	± 0.1
N	6.3	6	± 0.1
Y		6	± 1
Z		140	+ 5

* Measurements share this common tolerance unless otherwise stated.

Front view

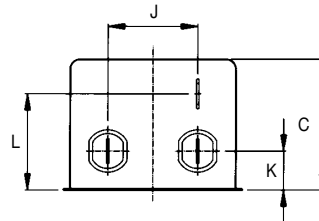

Housing K2

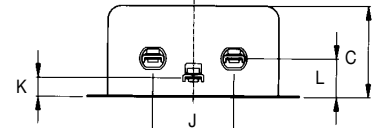

Housing L1

Top view

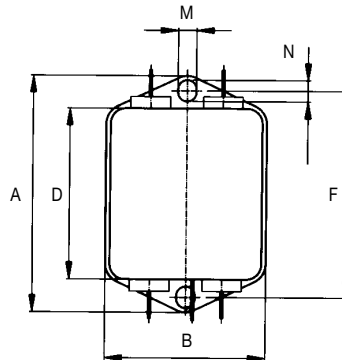

Housing K2

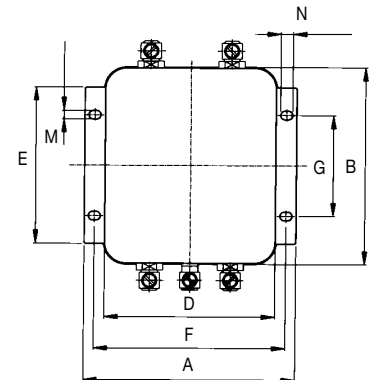

Housing L1

All dimensions in mm; 1 inch = 25.4 mm