

General Description

TMR1155 is a digital unipolar magnetic switch that integrates TMR and CMOS technology in order to provide a magnetically triggered digital switch with high sensitivity, high speed, and ultra-low power consumption. It is designed for use in applications that are both power-critical and performance-demanding. It contains a push-pull full-bridge TMR magnetic sensor and CMOS signal processing circuitry within the same package, including an on-chip TMR voltage generator for precise magnetic sensing, a TMR voltage amplifier and comparator plus a Schmitt trigger to provide switching hysteresis for noise rejection, and CMOS push-pull output. An internal band gap regulator is used to provide a temperature compensated supply voltage for internal circuits, permitting a wide range of supply voltages up to 40V. The TMR1155 draws only 0.6mA resulting in low power operation. It has fast response, accurate switching points, excellent thermal stability, and immunity to stray field interference. It is available in the SOT23-3 package (P/N TMR1155S) or the TO-92S package (P/N TMR1155T).

Features and Benefits

- Tunneling Magnetoresistance (TMR) Technology
- Low Power Consumption(<0.6mA)
- High Frequency Response(>1kHz)
- Unipolar Latching Operation
- Z-axis sensing direction compatible with Hall Effect
- Low Switching Points for High Sensitivity
- High Supply Voltage of 40V and 30V Reverse Voltage
- Open Drain Output
- Excellent Thermal Stability
- High Tolerance to External Magnetic Field Interference

Applications

- Utility Meters including Water, Gas, and Heat Meters
- Solid State Switches
- Position and Speed Sensing
- Motor and Fan Control
- Power Window



TMR1155S(Left), TMR1155T(Right)

Block Diagram

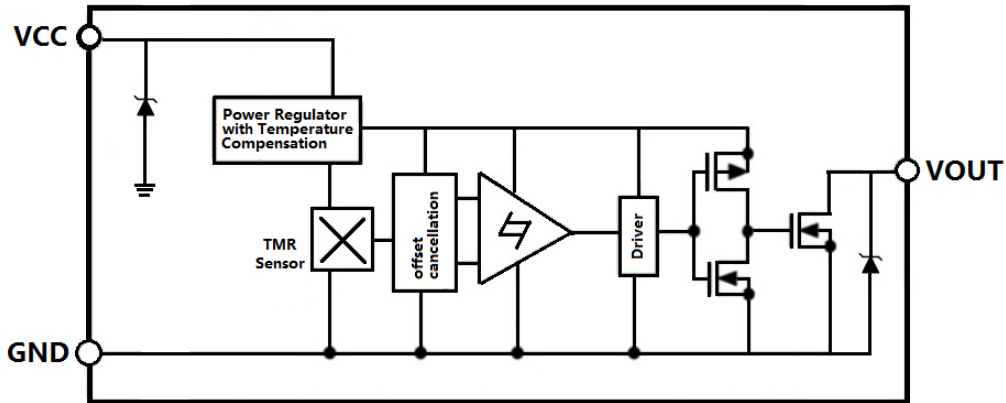

Pin Configuration

SOT23-3

TO-92S

Pin Name	Pin No.		Pin Function
	TO-92S	SOT23-3	
V _{CC}	1	1	Supply Voltage
GND	2	3	Ground
V _{OUT}	3	2	Output

Absolute Maximum Ratings

Parameter	Symbol	Limit	Unit
Supply Voltage	V _{CC}	40	V
Reverse Supply Voltage	V _{RCC}	30	V
Output Current	I _{OUTSINK}	25	mA
Magnetic Flux Density	B	4000	G
ESD level(HBM)	V _{ESD}	2	kV
Operating Ambient Temperature	T _A	-40 ~ 125	°C
Storage Temperature	T _{stg}	-50 ~ 150	°C

Electrical Characteristics (V_{CC}=24V, T_A=25°C)

Parameter	Symbol	Conditions	Min	Typ.	Max	Unit
Supply Voltage	V _{CC}	Operating	3	24	40	V
Output Stress Voltage	V _{stress}				40	V
Output leak Current	I _{leak}	OUT=H, V _{CC} =24V, V _{out} =24V		26		µA
Output Resistance of Turnoff	R _{off}	OUT=H		10		MΩ
Output Low Voltage	V _{OL}	OUT=L, V _{CC} =24V, I _{sink} =25mA			0.3	V
Output Resistance of Turn on	R _{on}	OUT=L			10	Ω
Supply Current	I _{CC}	Output Open	0.4	0.5	0.6	mA
Response Frequency	F			1	100	KHz

Note: a 1kOhm pull-up resistor is connected between V_{CC} and V_{OUT}, and a 100nF capacitor is connected between V_{CC} and GND during all tests in the above table.

Magnetic Characteristics ($V_{CC} = 24V, T_A = 25^\circ C$)

Parameters	Symbol	Min	Typ.	Max	Units
Operate Point	B_{OP}		70		G
Release Point	B_{RP}		55		G
Hysteresis	B_H		15		G

Note: a 1kOhm pull-up resistor is connected between V_{CC} and V_{OUT} , and a 100nF capacitor is connected between V_{CC} and GND during all tests in the above table.

Voltage Characteristics

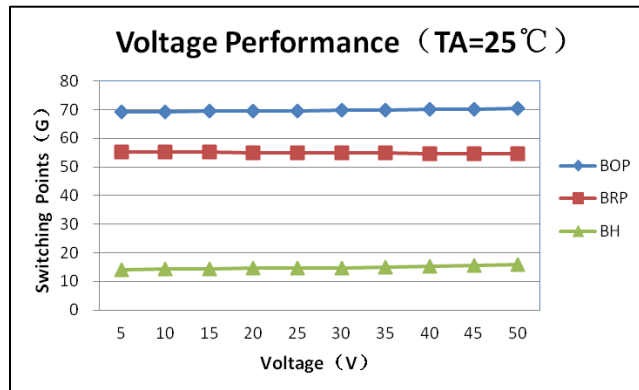

Output Behavior vs. Magnetic Pole

Parameter	Test Conditions	Output
South Pole applicable to TO92S	$B > B_{OP}$	Low (On)
South Pole applicable to TO92S	$B < B_{OP}$	High (Off)
North Pole applicable to SOT23	$B > B_{OP}$	Low (On)
North Pole applicable to SOT23	$B < B_{OP}$	High (Off)

Note: when power is turned on under zero magnetic field, the output is "High".

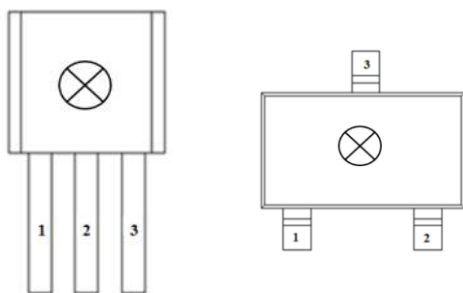

Sensing Direction of Magnetic Field(Z-Axis)

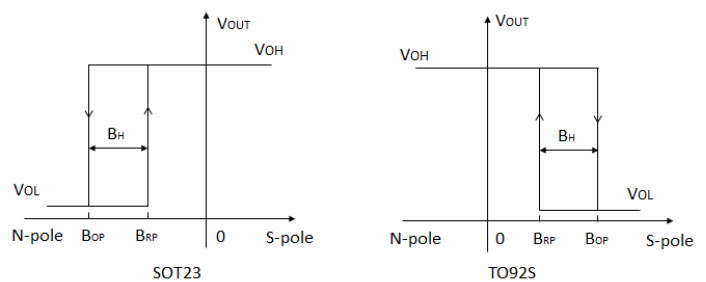

Magnetic Flux

Application Information

The output of the TMR1155 switches low (turns on) when a magnetic field to the sensing axis exceeds the operate point threshold, B_{OP} . When the magnetic field is reduced below the release point, B_{RP} , the device output switches high (turns off). The difference between the B_{OP} and B_{RP} is the hysteresis B_H of the device.

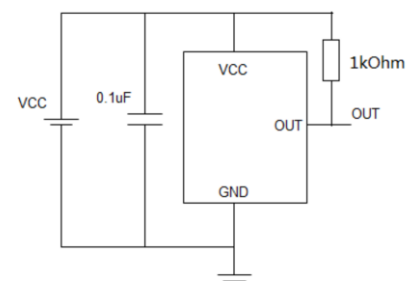

It is strongly recommended that an external bypass capacitor be connected in close proximity to the device between the supply and ground pins to reduce noise. The recommended value for the external bypass capacitor is 0.1µF.

Package Information

SOT23-3 package drawing

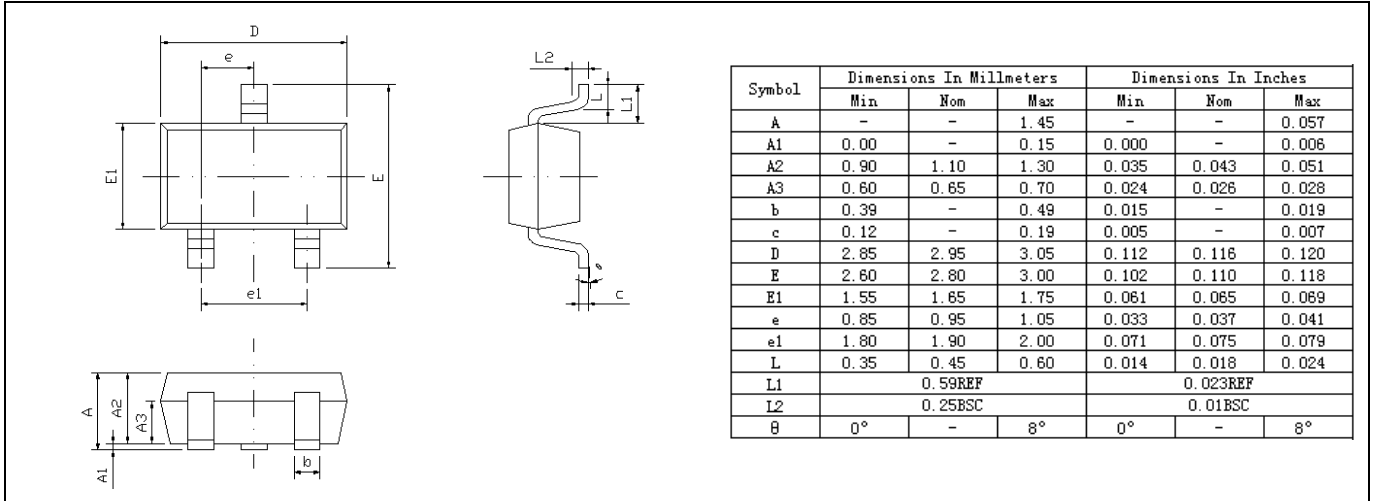

TO-92S package drawing

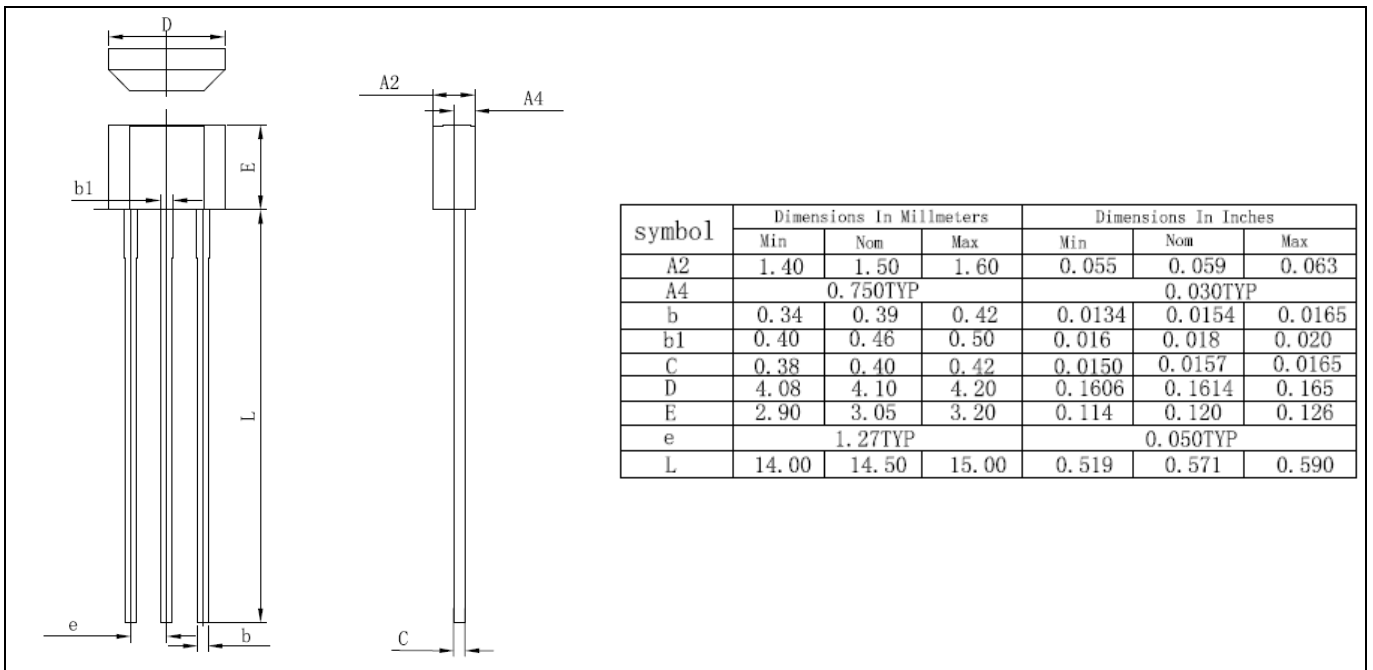

TMR Sensor Position

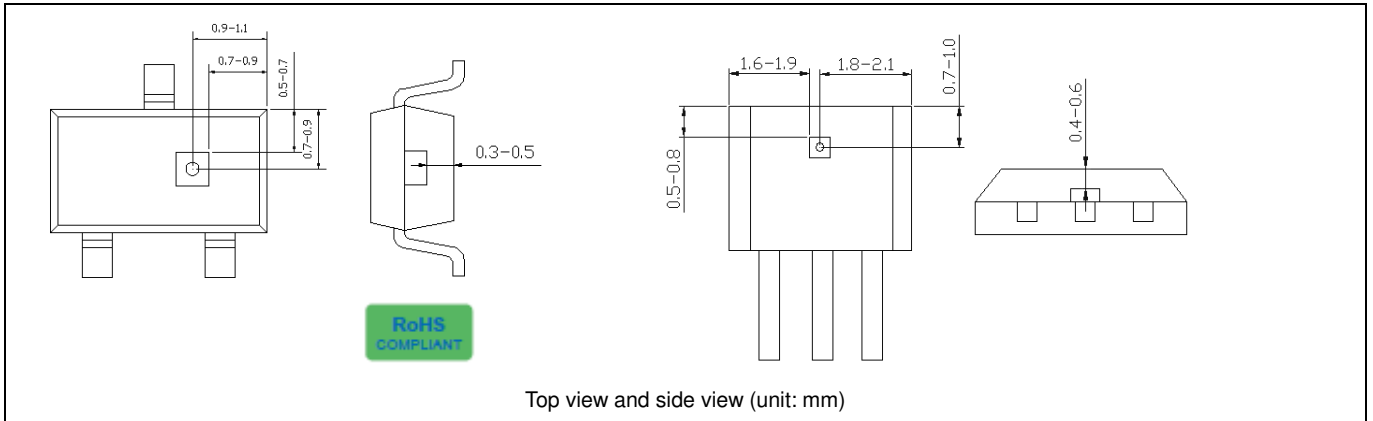

MultiDimension Technology Co., Ltd.

Address: No.7 Guangdong Road, Zhangjiagang Free Trade Zone, Jiangsu, 215634, China

Web: www.dowaytech.com/en

Email: info@dowaytech.com

The information provided herein by MultiDimension Technology Co., Ltd. (hereinafter MultiDimension) is believed to be accurate and reliable. Publication neither conveys nor implies any license under patent or other industrial or intellectual property rights. MultiDimension reserves the right to make changes to product specifications for the purpose of improving product quality, reliability, and functionality. MultiDimension does not assume any liability arising out of the application and use of its products. MultiDimension's customers using or selling this product for use in appliances, devices, or systems where malfunction can reasonably be expected to result in personal injury do so at their own risk and agree to fully indemnify MultiDimension for any damages resulting from such applications.