

PNMini-2A High-performance Easy-to-use Mini Power Modules for DIY Electronic Projects

With Adjustable Positive/Negative Output by Speedy Lab

Related Products:

- PNMini-500mA – 28V input, 500mA positive/negative DC/DC step down converter
- PMMini-2A – 28V input, 2A positive/negative DC/DC step down converter

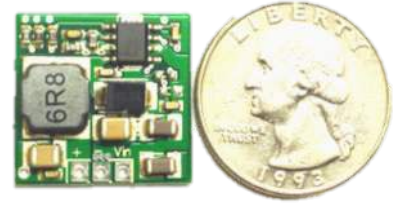

PNMini2A: +3.3V/-3.3V, +5V/-5V, +12V/-12V Output with Eco-mode and High Light Load Efficiency

The PNMini2A power module is a high efficiency converter (up to 92%) capable of driving up to 2A load without using heat sink. The PNMini2A is available in an innovative small PCB that enhances thermal performance and allows for hand soldering or plugin use. It requires no external components. It is a reliable, robust and allows startup into a pre-biased output. Other significant features like better output accuracy ($\pm 1\%$) and lower standby current of 0.3mA makes this module an ideal solution for many applications.

Key Features

- One Module Supports Positive/Negative Output
- High Efficiency at Light Loads 85%@Vin=7V
- 3.5V to 28V for Positive Input Voltage Range
- 2.7V to 27V for Negative Input Voltage Range
- Supports up to 2A Continuous Output Current (no heat sink required)
- Typical 5 μ A Shutdown Quiescent Current
- Slow Start Limits Inrush Currents
- UVLO Protection
- Overvoltage Transient Protection
- Thermal Shutdown Protection
- Cycle-by-cycle Current Limit enables Short Circuit Protection
- Simple Configuration

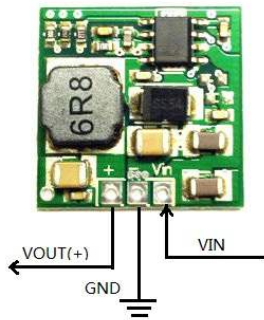

Positive Output Configuration

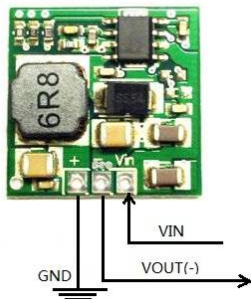

Negative Output Configuration

Applications

- Consumer Applications such as Set-Top Boxes, CPE Equipment, LCD Displays, Peripherals, and Battery Chargers
- Portable Electronics with Sleep Mode
- Industrial and Car Audio Power Supplies
- DIY Electronic Projects

Output Voltage Programming

The output voltage can be programmed by three resistors: Rfb1, Rfb2, and R3. The output voltage is calculated by the following equation:

$$V_{out} = 0.8V \times \left(\frac{Rfb1 || Rfb2}{R3} + 1 \right) = 0.8V \times \left(\frac{Rfb1 \times Rfb2}{R3 \times (Rfb1 + Rfb2)} + 1 \right)$$

Only one resistor is needed for (Rfb1 | | Rfb2). Two footprints are provided here to add flexibility in resistor value selection.

The three resistors are connected at the output terminal. They are located at the upper right corner on the assembly drawing.

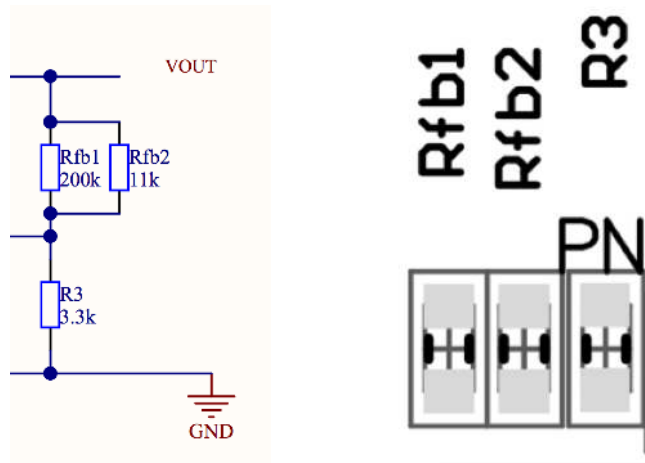

Below are some possible resistor values for different output voltages:

| Output Voltage (V) | R3 (ohm) | Rfb1 Rfb2 (ohm) |
|--------------------|----------|---------------------|
| 0.9 | 80.6k | 10k |
| 1.8 | 8.06k | 10k |
| 2.5 | 4.7k | 10k |
| 3.3 | 3.24k | 10k |
| 5 | 1.91k | 10k |
| 9 | 975 | 10k |
| 12 | 714 | 10k |

Typical Electrical Characteristics (Room Temperature)

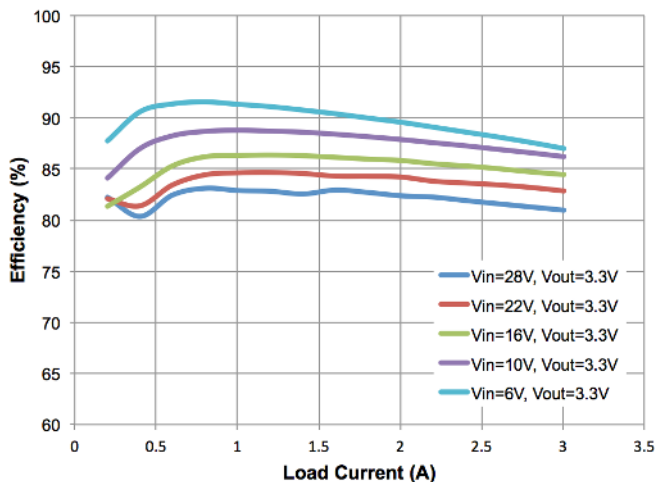

Figure 1. Efficiency at 3.3V output

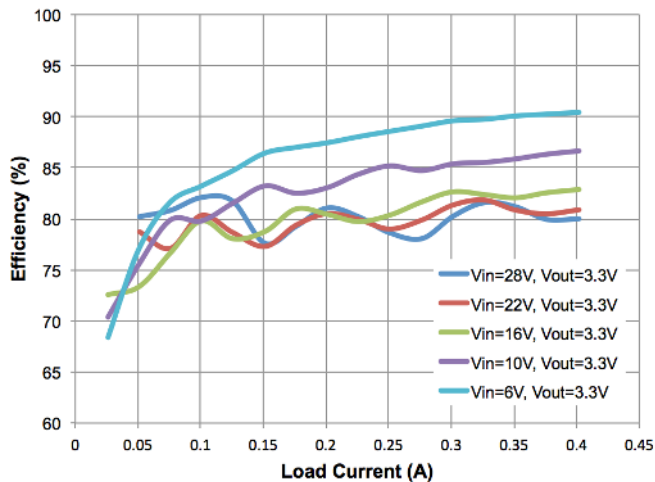

Figure 2. Light load efficiency at 3.3V output

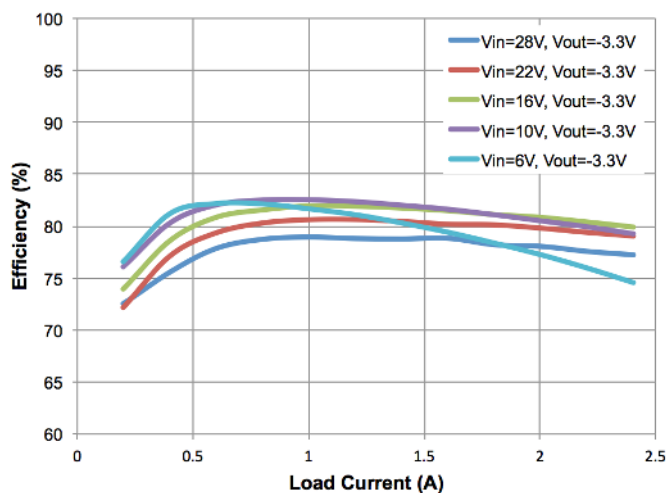

Figure 3. Efficiency at -3.3V output

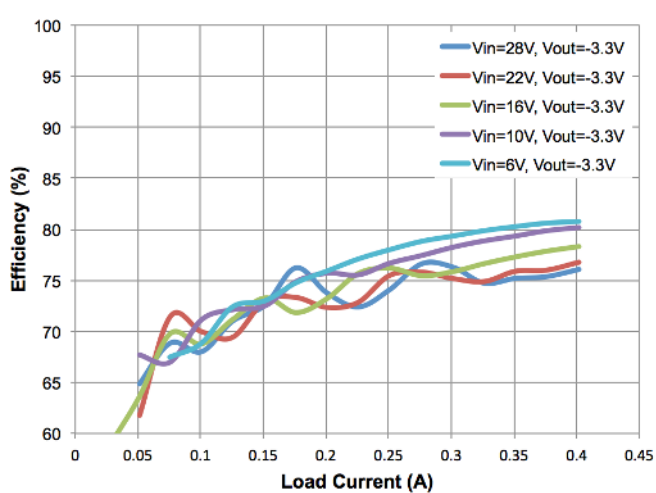

Figure 4. Light load efficiency at -3.3V output

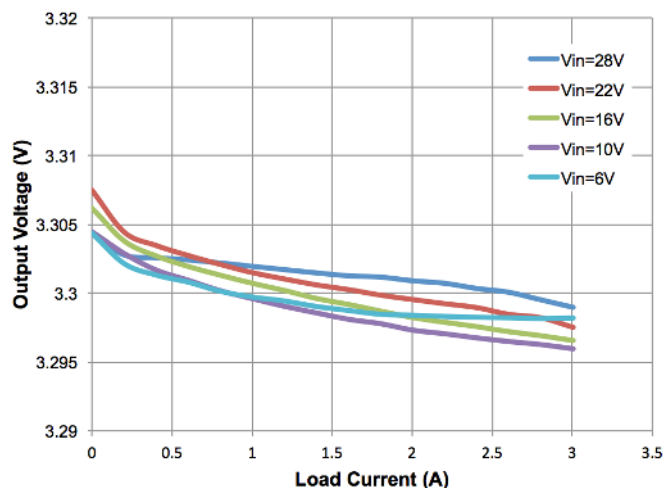

Figure 5. Load regulation at 3.3V output

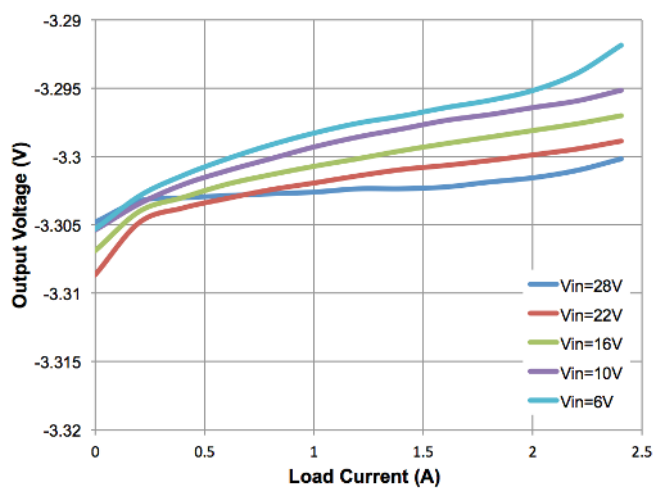

Figure 6. Load regulation at -3.3V output

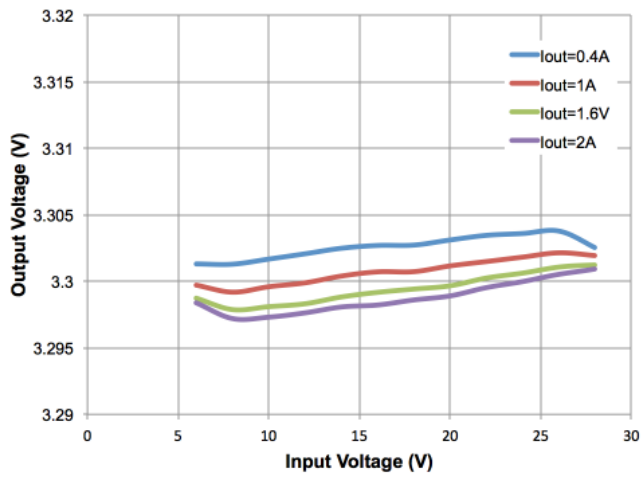

Figure 7. Line regulation at 3.3V output

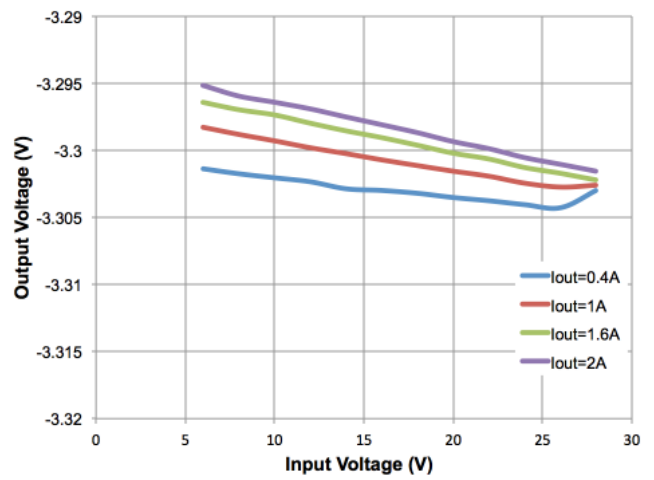

Figure 8. Line regulation at -3.3V output

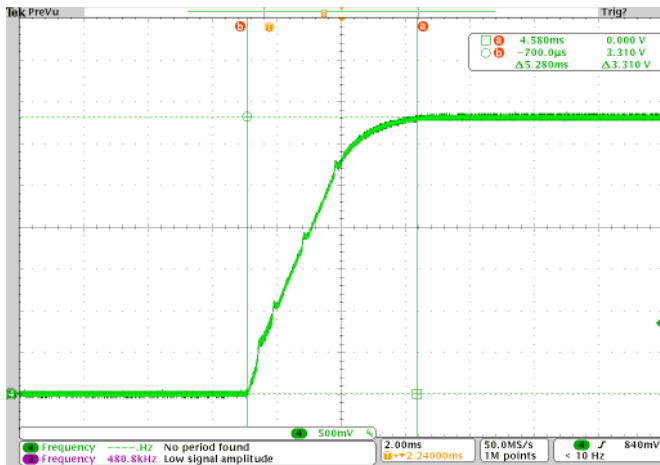

Figure 9. Soft start at Vin=7V, Iout=2A

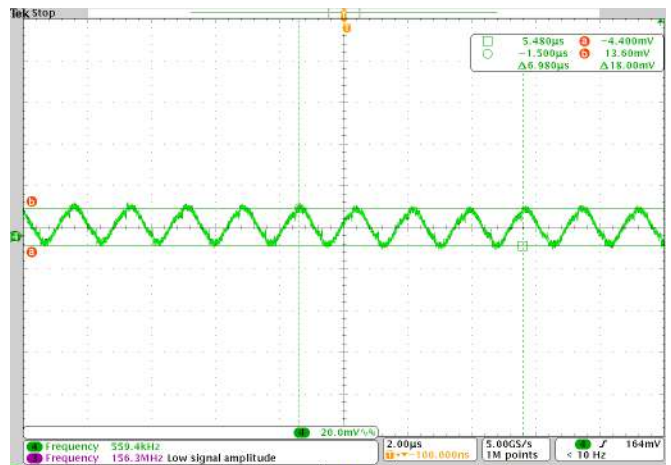

Figure 10. Vout ripple at Vin=7V, Vout=2A

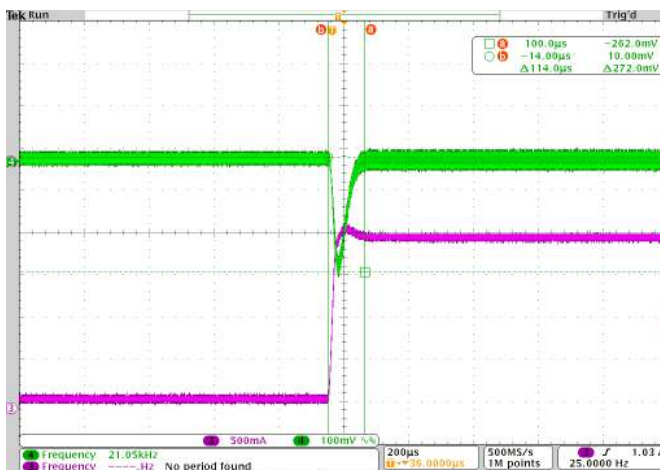

Figure 11. Load transient at Vin=25V, Iout=0~2A

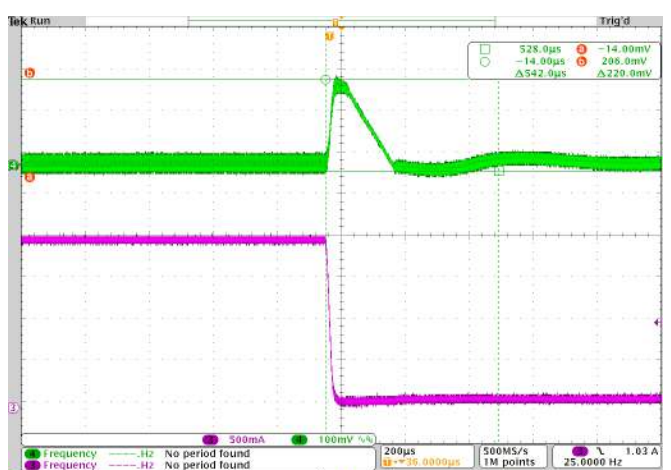
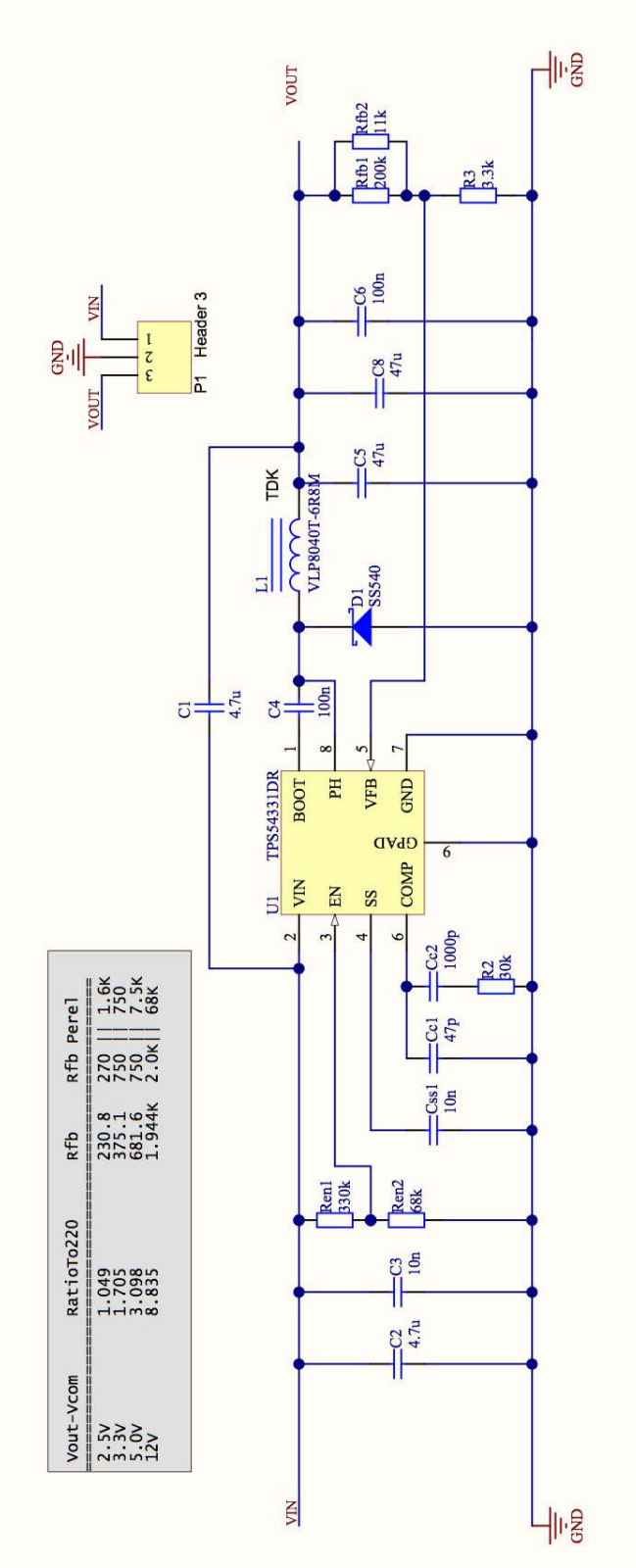

Figure 12. Load transient at Vin=25V, Iout=2~0A

Schematic



BOM

| NO. | Description | Designator | Manufacturer |
|-----|--|----------------------|--------------|
| 1 | GRM31CR71H475KA12L 4.7u 1206 Capacitor 50V X7R | C1,C2 | MURATA |
| 2 | CL10B103KB8NNNC 10n 0603 Capacitor 50V X7R | C3,Css1 | SAMSUNG |
| 3 | CL10B104KB8NNNC 100n 0603 Capacitor 50V X7R | C4,C6 | SAMSUNG |
| 4 | CL10C470JB8NNNC 47p 0603 Capacitor 50V X7R | Cc1 | SAMSUNG |
| 5 | CL10B102KB8NNNC 1000p 0603 Capacitor 50V X7R | Cc2 | SAMSUNG |
| 6 | 2.54mm, Header, 3-Pin | P1 Do not populate | |
| 7 | 2.54mm, Header, 3-Pin | P1 Do not populate | |
| 8 | 30k 0603 Resistor,1% | R2 | Super ohms |
| 9 | 3.3k 0603 Resistor,1% | R3 | Super ohms |
| 10 | 330k 0603 Resistor,1% | Ren1 Do not populate | Super ohms |
| 11 | 68k 0603 Resistor,1% | Ren2 Do not populate | Super ohms |
| 12 | 200k 0603 Resistor,1% | Rfb1 | Super ohms |
| 13 | 11k 0603 Resistor,1% | Rfb2 | Super ohms |
| 14 | 3.5A 6.8uH 7.4mm*7.4mm*3.5mm HPC8040B-6R8Y | L1 | TaiTech |
| 16 | SMB SS54 SMB 3.5mm*4.8mm | D1 | MDD |
| 18 | GRM32ER61C476KE15L x5r 16V 1210 47uF | C5,C8 | MURATA |
| 19 | TPS54331D | U1 | TI |

Assembly Drawing

