



## 0.5 DB LSB GAAS MMIC 5-BIT DIGITAL ATTENUATOR, 0.7 - 3.8 GHz

### Typical Applications

The HMC306AMS10 / 306AMS10E is ideal for:

- Cellular; UMTS/3G Infrastructure
- ISM, MMDS, WLAN, WiMAX
- Microwave Radio & VSAT
- Test Equipment and Sensors

### Features

- RoHS-Compliant Product
- 0.5 dB LSB Steps to 15.5 dB
- Single Positive Control Per Bit
- ± 0.2 dB Typical Bit Error
- Miniature 15 mm<sup>2</sup> Package: MSOP10

### Functional Diagram

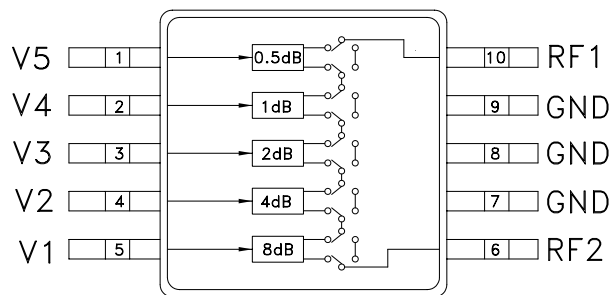

### General Description

The HMC306AMS10 & HMC306AMS10E are general purpose broadband 5-bit positive control GaAs IC digital attenuators in 10 lead MSOP surface mount plastic packages. Covering 0.7 to 3.8 GHz, the insertion loss is typically less than 1.5 to 2.3 dB. These attenuators' bit values are 0.5 (LSB), 1, 2, 4 and 8 dB for a total attenuation of 15.5 dB. Attenuation accuracy is excellent at ± 0.2 dB typical with an IIP3 of up to +52 dBm. Five bit control voltage inputs, toggled between 0 and +3 to +5V, are used to select each attenuation state. A single Vdd bias of +3 to +5V applied through an external 5K Ohm resistor is required.

### Electrical Specifications,

$T_A = +25^\circ C$ ,  $V_{dd} = +3V$  to  $+5V$  &  $V_{CTL} = 0/V_{dd}$  (Unless Otherwise Stated)

Parameter	Frequency (GHz)	Min.	Typical	Max.	Units
Insertion Loss	0.7 - 1.4		1.3	1.6	dB
	1.4 - 2.3		1.5	2.0	dB
	2.3 - 2.7		1.8	2.5	dB
	2.7 - 3.8		2.3	2.7	dB
Attenuation Range			15.5		dB
Return Loss (RF1 & RF2, All Atten. States)	0.7 - 1.4	15	21		dB
	1.4 - 2.3	14	18		dB
	2.3 - 2.7	13	16		dB
	2.7 - 3.8	10	13		dB
Attenuation Accuracy: (Referenced to Insertion Loss)	0.7 - 1.4	± (0.30 + 5% of Atten. Setting) Max.			dB
	1.4 - 2.3	± (0.25 + 3% of Atten. Setting) Max.			dB
	1.4 - 2.3	± (0.15 + 3% of Atten. Setting) Max.			dB
	2.3 - 3.8	± (0.30 + 3% of Atten. Setting) Max.			dB
Input Power for 0.1 dB Compression	0.7 - 3.8	Vdd = 5V	28		dBm
		Vdd = 3V	27		dBm
Input Third Order Intercept Point (Two-tone Input Power = 10 dBm Each Tone)	0.7 - 3.8	Vdd = 5V	52		dBm
		Vdd = 3V	48		dBm
Switching Characteristics	0.7 - 3.8	tRISE, tFALL (10/90% RF)	560		ns
		tON, tOFF (50% CTL to 10/90% RF)	600		ns



# HMC306AMS10 / 306AMS10E

## 0.5 DB LSB GAAS MMIC 5-BIT DIGITAL ATTENUATOR, 0.7 - 3.8 GHz

### Insertion Loss

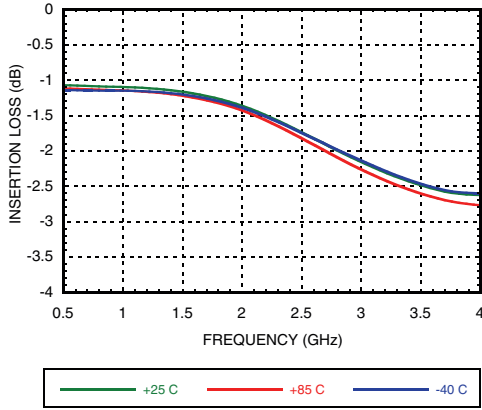

### Return Loss RF1, RF2 (Only Major States are Shown)

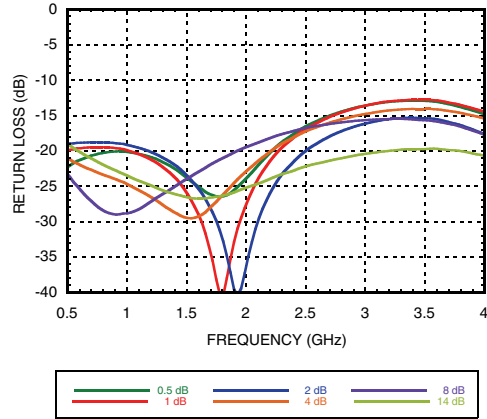

### Normalized Attenuation (Only Major States are Shown)

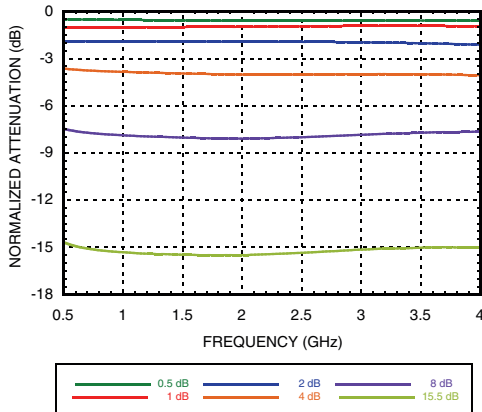

### Absolute Bit Error vs. Attenuation State

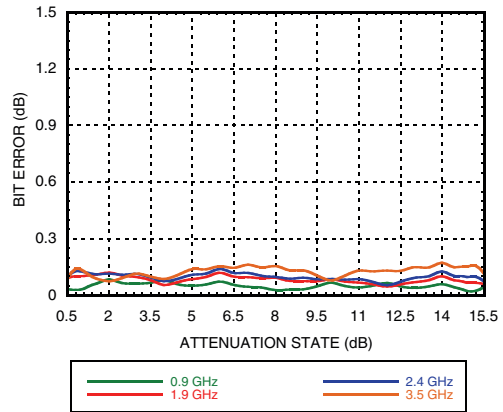

### Absolute Bit Error vs. Frequency (Only Major States are Shown)

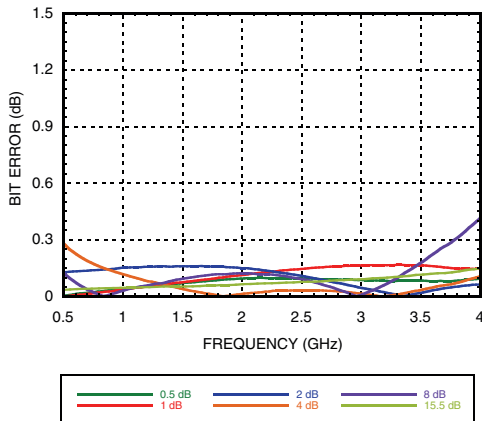

### Relative Phase vs. Frequency (Only Major States are Shown)

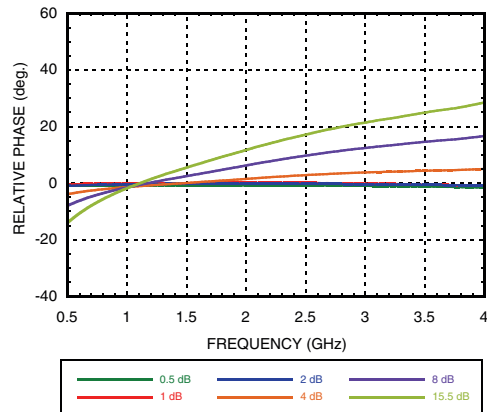

Information furnished by Analog Devices is believed to be accurate and reliable. However, no responsibility is assumed by Analog Devices for its use, nor for any infringements of patents or other rights of third parties that may result from its use. Specifications subject to change without notice. No license is granted by implication or otherwise under any patent or patent rights of Analog Devices. Trademarks and registered trademarks are the property of their respective owners.

For price, delivery, and to place orders: Analog Devices, Inc., One Technology Way, P.O. Box 9106, Norwood, MA 02062-9106 Phone: 781-329-4700 • Order online at [www.analog.com](http://www.analog.com) Application Support: Phone: 1-800-ANALOG-D



## 0.5 DB LSB GAAS MMIC 5-BIT DIGITAL ATTENUATOR, 0.7 - 3.8 GHz

### Truth Table

Control Voltage Input					Attenuation State RF1 - RF2
V1 8 dB	V2 4 dB	V3 2 dB	V4 1 dB	V5 0.5 dB	
High	High	High	High	High	Reference I.L.
High	High	High	High	Low	0.5 dB
High	High	High	Low	High	1 dB
High	High	Low	High	High	2 dB
High	Low	High	High	High	4 dB
Low	High	High	High	High	8 dB
Low	Low	Low	Low	Low	15.5 dB Max. Atten.

Any combination of the above states will provide an attenuation approximately equal to the sum of the bits selected.



**ELECTROSTATIC SENSITIVE DEVICE  
OBSERVE HANDLING PRECAUTIONS**

### Outline Drawing

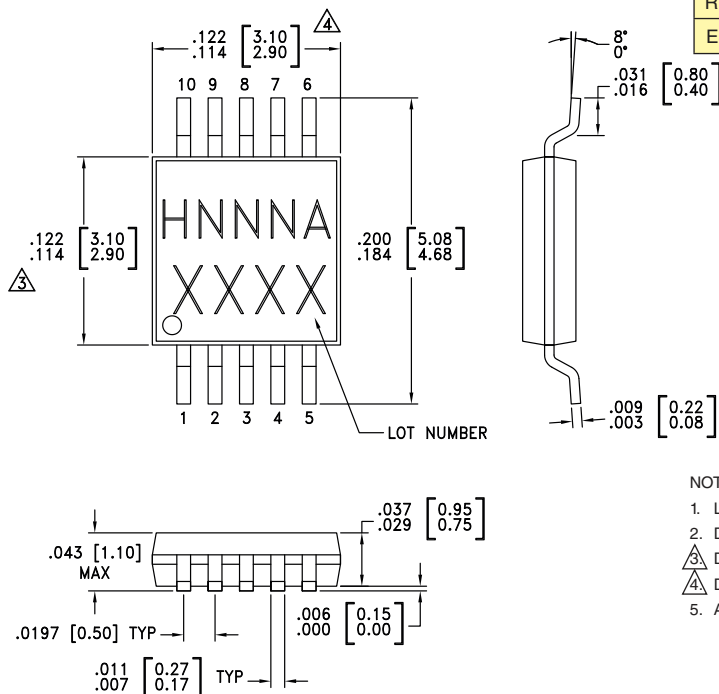

### Control & Bias Voltages

State	Bias Condition
Low	0 to +0.2V @ 20 $\mu$ A Max.
High	Vdd $\pm$ 0.2V @ 20 $\mu$ A Max.

Note: Vdd = +3V to 5V  $\pm$  0.2V

### Absolute Maximum Ratings

Control Voltage (V1 - V5)	Vdd + 0.2 Vdc
Bias Voltage (Vdd)	+8 Vdc
Channel Temperature	150 °C
Continuous Pdiss (T = 85 °C) (derate 7.8 mW/ °C above 85 °C)	0.506 W
Thermal Resistance (Channel to package bottom)	128.5 °C/w
Storage Temperature	-65 to +150 °C
Operating Temperature	-40 to +85 °C
RF Input Power (0.7 - 3.8 GHz)	+27 dBm
ESD Sensitivity (HBM)	Class 1A

#### NOTES:

- LEADFRAME MATERIAL: COPPER ALLOY
- DIMENSIONS ARE IN INCHES [MILLIMETERS].
- $\triangle$  DIMENSION DOES NOT INCLUDE MOLDFLASH OF 0.15mm PER SIDE.
- $\triangle$  DIMENSION DOES NOT INCLUDE MOLDFLASH OF 0.25mm PER SIDE.
- ALL GROUND LEADS MUST BE SOLDERED TO PCB RF GROUND.

### Package Information

Part Number	Package Body Material	Lead Finish	MSL Rating	Package Marking <sup>[3]</sup>
HMC306AMS10	Low Stress Injection Molded Plastic	Sn/Pb Solder	MSL1 <sup>[1]</sup>	H306A XXXX
HMC306AMS10E	RoHS-compliant Low Stress Injection Molded Plastic	100% matte Sn	MSL1 <sup>[2]</sup>	H306A XXXX

[1] Max peak reflow temperature of 235 °C

[2] Max peak reflow temperature of 260 °C

[3] 4-Digit lot number XXXX



**0.5 DB LSB GAAS MMIC 5-BIT DIGITAL ATTENUATOR, 0.7 - 3.8 GHz**

**Application Circuit**

Note:  
DC Blocking Capacitors C1 & C2 are required on RF1 & RF2. Choose C1 = C2 = 100 ~ 300 pF to allow lowest customer specific frequency to pass with minimal loss. R1= 5K Ohm is required to supply voltage to the circuit through either Pin 6 or Pin 10.

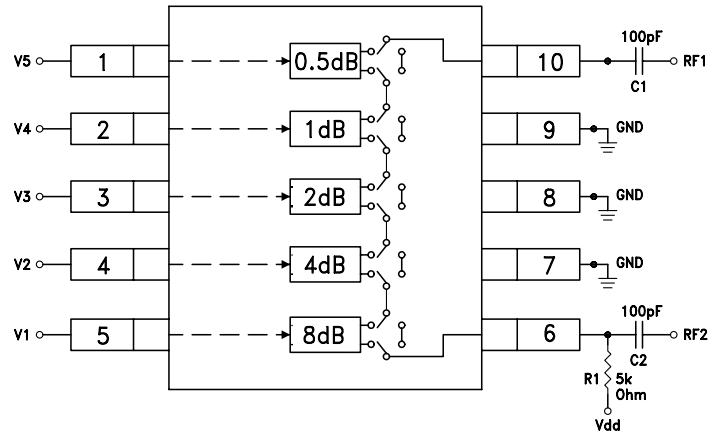

**Evaluation Circuit Board**

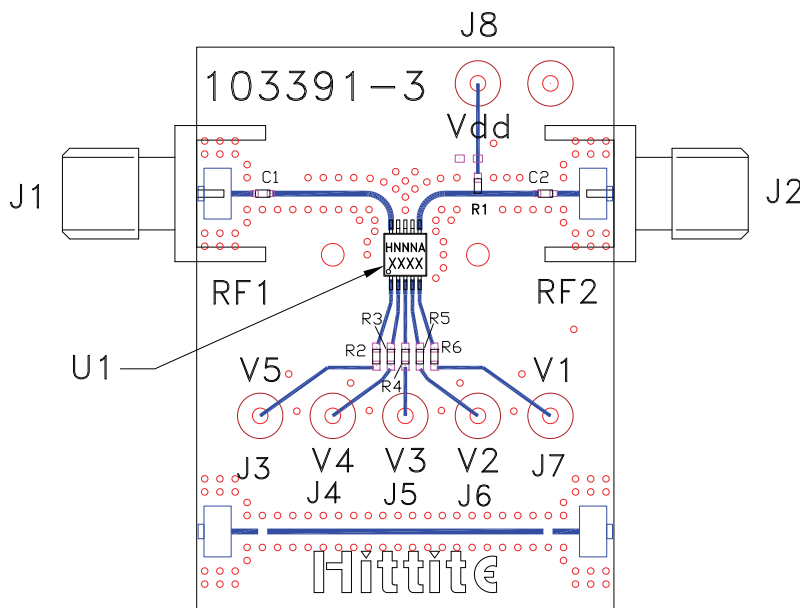

\* R2 - R6= 100 Ohm.  
These resistors are optional and may be used to enhance decoupling of the RF path from the control inputs.

**List of Materials for Evaluation PCB EVAL01 - HMC306AMS10 [1]**

Item	Description
J1 - J2	PCB Mount SMA Connector
J3 - J8	DC Pin
R1	5 kOhm Resistor, 0402 Pkg.
R2 - R6	100 Ohm Resistor, 0402 Pkg.
C1 - C2	0402 Chip Capacitor, Select Value for Lowest Frequency
U1	HMC306AMS10 / 306AMS10E Digital Attenuators
PCB [2]	103391 Evaluation PCB 1.5" x 1.5"

[1] Reference this number when ordering complete evaluation PCB

[2] Circuit Board Material: Rogers 4350

The circuit board used in the application should use RF circuit design techniques. Signal lines should have 50 Ohm impedance while the package ground leads should be connected directly to the ground plane similar to that shown. A sufficient number of via holes should be used to connect the top and bottom ground planes. The evaluation circuit board shown is available from Hittite upon request.