

極数 POS.	品番 No.	A	B	C
2	13103S-02*-NP	11.4	6	2
4	13103S-04*-NP	15.4	10	6
8	13103S-08*-NP	23.4	18	14
10	13103S-10*-NP	27.4	22	18
12	13103S-12*-NP	31.4	26	22
16	13103S-16*-NP	39.4	34	30
20	13103S-20*-NP	47.4	42	38

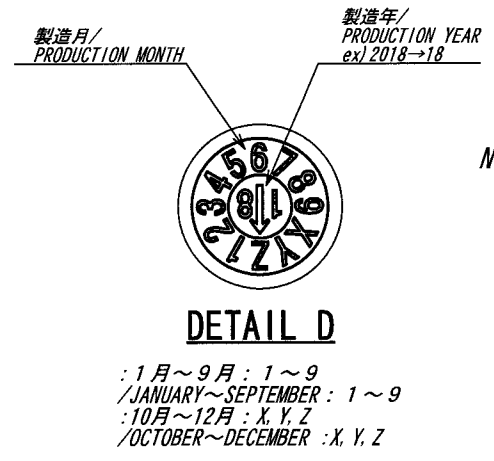
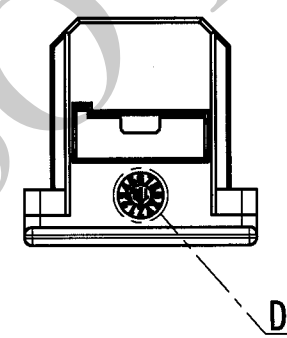
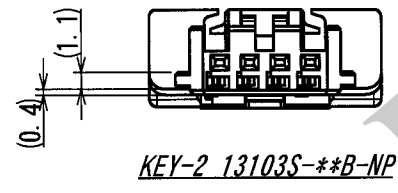
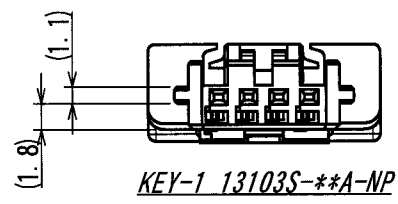
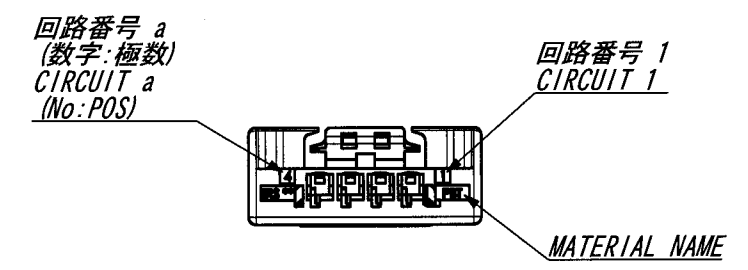
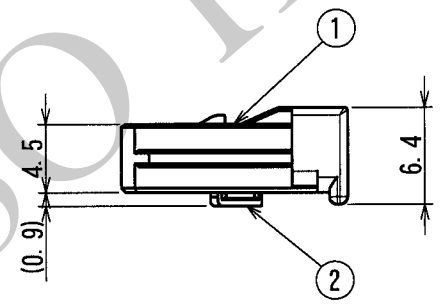
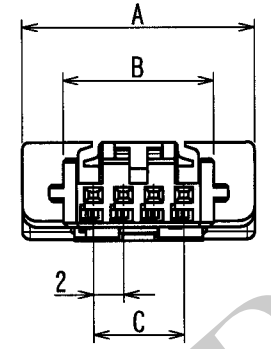
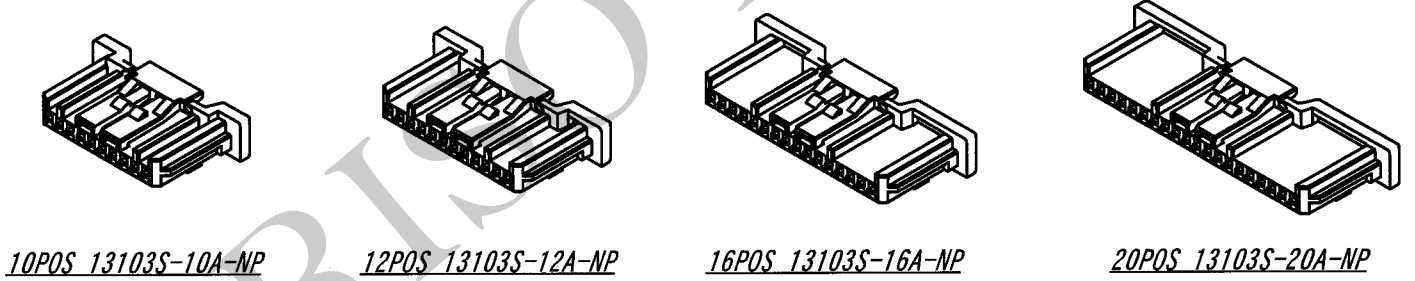
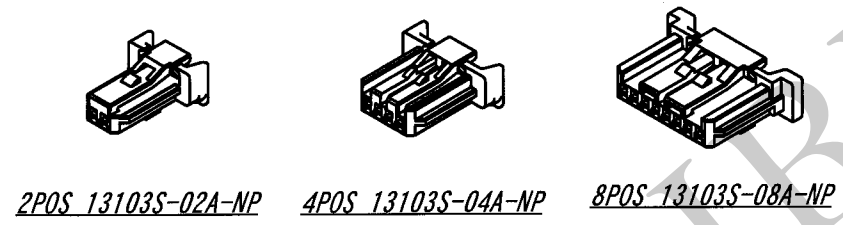
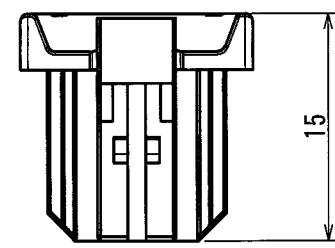

NOTE:

1. 仮係止時リテーナ突起がハウジングの外側に出ていること。  
(リテーナが仮係止状態)  
納品時、本係止状態になっている場合は、仮係止状態にして下さい。

1. THE RETENTION LATCH OF THE RETAINER MUST BE OUT SIDE OF SOCKET HOUSING WHEN PRE-ASSEMBLY. (RETAINER IS IN PRE-ASSEMBLED CONDITION) WHEN THE RETAINER IS IN FINAL LOCK CONDITION AT THE SHIPPED TO CUSTOMER, IT MUST BE UNLOCKED TO PRE-ASSEMBLED CONDITION.

MATERIAL 材質		GENERAL TOLERANCES 一般公差		SCALE 尺度		UNIT 単位		TITLE 名称	
①SOCKET HOUSING : PBT樹脂,UL94 V0、黒色/ PBT ,UL94 V0,COLOR:BLACK		DIM 寸法 ± 0.3		2:1		mm		13103シリーズ ソケット SERIES 13103 SOCKET	
②RETAINER : PBT樹脂,UL94 V0、ナチュラル/ PBT,UL94 V0,COLOR:NATURAL		ANGLE 角度 ± 3°		DR 2019.12.24 D.Kitazawa		DSN 2018.10.16 D.Kitazawa			
FINISH 仕上げ		3RD.ANG.PROJ. 三角法		CHK 2019.12.25 T.Sakamoto		APP 12/19 H.Kobayashi		PARTS No. 部番 IMSA-13103S-***-NP	
192658		RELEASED		D.K		T.S		19 12/25	
0		SCHETCHED		D.K		T.S		'18 10/29	
LTR 記号		REVISION RECORD 記 事		DR		CHK		DATE 年月日	
								SHEET No. 1 OF 1	
								REV. 1	
						IRISO ELECTRONICS CO.,LTD イリス電子工業株式会社		DWG No. 図番 110-413103-415	