

REV	DESCRIPTION	DATE	APP
00	NEW DRAWING	10/10/12	D.D.

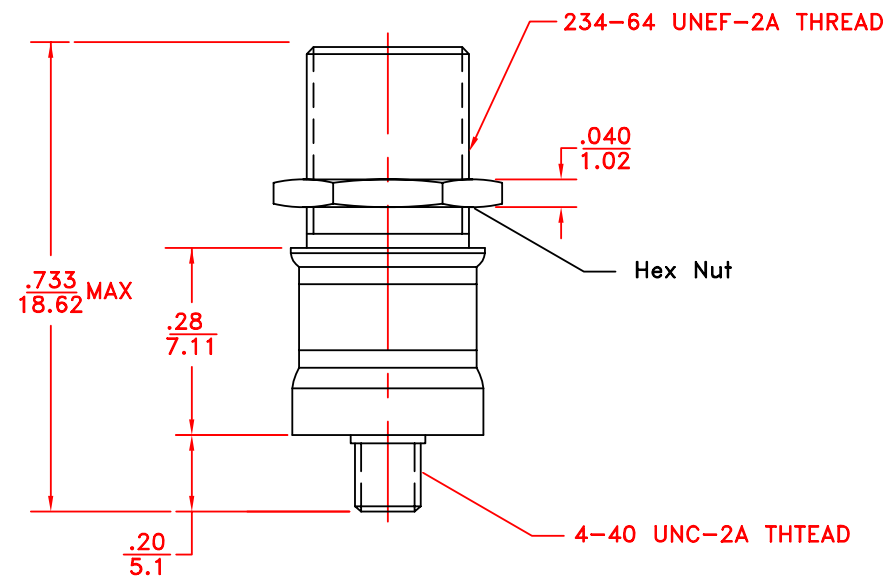
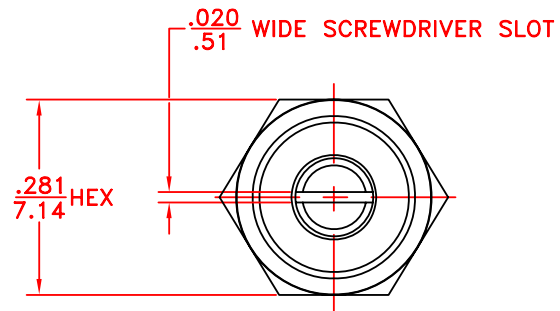

NOTES:

1. Capacitance Range: ≤ 1.0 to ≥ 10.0 pF.
2. Working Voltage 1000 VDC
3. Withstanding Voltage test at 2000 VDC
4. $Q @ C_{max}$ and 100 MHz > 2000
5. Operating Temperature $-55^{\circ}C$ to $+125^{\circ}C$
6. TC 0 ± 50 ppm
7. Adjustment Torque .5 to 5.0 oz-in
8. Dimensions: (in/mm)
9. Construction: nonmagnetic

TOLERANCES: (EXCEPT AS NOTED)				SPRAGUE GOODMAN ELECTRONICS INC. 1700 SHAMES DRIVE WESTBURY, NY 11590			
DECIMAL: .XX \pm .010 IN .XXX \pm .005mm		MATERIAL:		SCALE: 4:1		DRAWN BY: R. LEVIN	
FRACTIONAL: 1/64		TITLE: OUTLINE DWG SGNMA3T10003				APPROVED: D. DITLYA	
ANGULAR: 1 $^{\circ}$		DATE: 10/10/12		DRAWING NUMBER SGNMA3T10003		USED FOR: REV. 00	