

# RF Power Field Effect Transistors

## N-Channel Enhancement-Mode Lateral MOSFETs

Designed for base station applications with wide instantaneous bandwidth requirements covering frequencies from 2300 to 2400 MHz.

- Typical Doherty Single-Carrier W-CDMA Performance:  $V_{DD} = 28$  Volts,  $I_{DQA} = 600$  mA,  $V_{GSB} = 1.2$  Vdc,  $P_{out} = 30$  Watts Avg., IQ Magnitude Clipping, Channel Bandwidth = 3.84 MHz, Input Signal PAR = 9.9 dB @ 0.01% Probability on CCDF.

Frequency	$G_{ps}$ (dB)	$\eta_D$ (%)	Output PAR (dB)	ACPR (dBc)
2300 MHz	13.9	37.1	7.9	-31.0
2350 MHz	14.1	38.3	7.7	-32.2
2400 MHz	13.8	38.3	7.4	-33.1

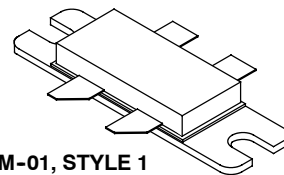
- Capable of Handling 10:1 VSWR, @ 30 Vdc, 2350 MHz, 144 Watts CW (1) Output Power (3 dB Input Overdrive from Rated  $P_{out}$ )
- Typical  $P_{out}$  @ 3 dB Compression Point  $\approx$  190 Watts (2)

### Features

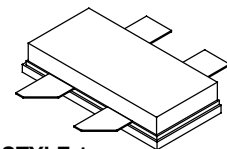
- Designed for Wide Instantaneous Bandwidth Applications
- Designed for Wideband Applications that Require 100 MHz Signal Bandwidth
- Production Tested in a Symmetrical Doherty Configuration
- 100% PAR Tested for Guaranteed Output Power Capability
- Characterized with Large-Signal Load-Pull Parameters and Common Source S-Parameters
- Internally Matched for Ease of Use
- Integrated ESD Protection
- Greater Negative Gate-Source Voltage Range for Improved Class C Operation
- Designed for Digital Predistortion Error Correction Systems
- NI-780-4 in Tape and Reel. R3 Suffix = 250 Units, 56 mm Tape Width, 13 inch Reel. For R5 Tape and Reel option, see p. 14.
- NI-780S-4 in Tape and Reel. R3 Suffix = 250 Units, 32 mm Tape Width, 13 inch Reel. For R5 Tape and Reel option, see p. 14.

**MRF8P23160WHR3**  
**MRF8P23160WHSR3**

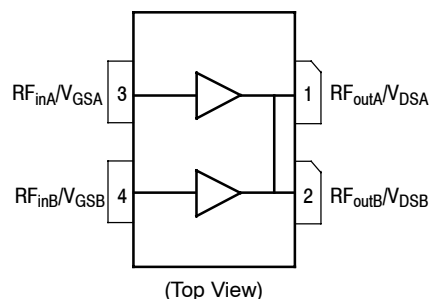
**2300-2400 MHz, 30 W AVG., 28 V**  
**SINGLE W-CDMA**  
**LATERAL N-CHANNEL**  
**RF POWER MOSFETs**



**CASE 465M-01, STYLE 1**  
**NI-780-4**  
**MRF8P23160WHR3**



**CASE 465H-02, STYLE 1**  
**NI-780S-4**  
**MRF8P23160WHSR3**



**Figure 1. Pin Connections**

**Table 1. Maximum Ratings**

Rating	Symbol	Value	Unit
Drain-Source Voltage	$V_{DSS}$	-0.5, +65	Vdc
Gate-Source Voltage	$V_{GS}$	-6.0, +10	Vdc
Operating Voltage	$V_{DD}$	32, +0	Vdc
Storage Temperature Range	$T_{stg}$	-65 to +150	$^{\circ}C$
Case Operating Temperature	$T_C$	125	$^{\circ}C$
Operating Junction Temperature (3,4)	$T_J$	225	$^{\circ}C$
CW Operation @ $T_C = 25^{\circ}C$ Derate above $25^{\circ}C$	CW	129 0.48	W W/ $^{\circ}C$

1. Exceeds recommended operating conditions. See CW operation data in Maximum Ratings table.
2.  $P_{3dB} = P_{avg} + 7.0$  dB where  $P_{avg}$  is the average output power measured using an unclipped W-CDMA single-carrier input signal where output PAR is compressed to 7.0 dB @ 0.01% probability on CCDF.
3. Continuous use at maximum temperature will affect MTTF.
4. MTTF calculator available at <http://www.freescale.com/rtf>. Select Software & Tools/Development Tools/Calculators to access MTTF calculators by product.

**Table 2. Thermal Characteristics**

Characteristic	Symbol	Value (1,2)	Unit
Thermal Resistance, Junction to Case Case Temperature 80°C, 30 W CW, 28 Vdc, I <sub>DQA</sub> = 600 mA, V <sub>GGB</sub> = 2.4 Vdc, 2350 MHz Case Temperature 101°C, 130 W CW(3), 28 Vdc, I <sub>DQA</sub> = 600 mA, V <sub>GGB</sub> = 2.4 Vdc, 2350 MHz	R <sub>θJC</sub>	0.69 0.43	°C/W

**Table 3. ESD Protection Characteristics**

Test Methodology	Class
Human Body Model (per JESD22-A114)	2
Machine Model (per EIA/JESD22-A115)	B
Charge Device Model (per JESD22-C101)	IV

**Table 4. Electrical Characteristics** (T<sub>A</sub> = 25°C unless otherwise noted)

Characteristic	Symbol	Min	Typ	Max	Unit
----------------	--------	-----	-----	-----	------

**Off Characteristics**

Zero Gate Voltage Drain Leakage Current (V <sub>DS</sub> = 65 Vdc, V <sub>GS</sub> = 0 Vdc)	I <sub>DSS</sub>	—	—	10	μAdc
Zero Gate Voltage Drain Leakage Current (V <sub>DS</sub> = 28 Vdc, V <sub>GS</sub> = 0 Vdc)	I <sub>DSS</sub>	—	—	5	μAdc
Gate-Source Leakage Current (V <sub>GS</sub> = 5 Vdc, V <sub>DS</sub> = 0 Vdc)	I <sub>GSS</sub>	—	—	1	μAdc

**On Characteristics**

Gate Threshold Voltage (V <sub>DS</sub> = 10 Vdc, I <sub>D</sub> = 252 μAdc)	V <sub>GS(th)</sub>	1.2	1.9	2.7	Vdc
Gate Quiescent Voltage (V <sub>DS</sub> = 28 Vdc, I <sub>DA</sub> = 600 mAdc)	V <sub>GSA(Q)</sub>	—	2.8	—	Vdc
Fixture Gate Quiescent Voltage (4,5) (V <sub>DD</sub> = 28 Vdc, I <sub>DA</sub> = 600 mAdc, Measured in Functional Test)	V <sub>GGA(Q)</sub>	4.1	5.5	7.1	Vdc
Drain-Source On-Voltage (V <sub>GS</sub> = 10 Vdc, I <sub>D</sub> = 3.0 Adc)	V <sub>DS(on)</sub>	0.1	0.24	0.3	Vdc

**Functional Tests** (6,7,8) (In Freescale Doherty Test Fixture, 50 ohm system) V<sub>DD</sub> = 28 Vdc, I<sub>DQA</sub> = 600 mA, V<sub>GGB</sub> = 1.2 Vdc, P<sub>out</sub> = 30 W Avg., f = 2320 MHz, Single-Carrier W-CDMA, IQ Magnitude Clipping, Input Signal PAR = 9.9 dB @ 0.01% Probability on CCDF. ACPR measured on 3.84 MHz Channel Bandwidth @ ±5 MHz Offset.

Power Gain	G <sub>ps</sub>	12.0	14.1	15.0	dB
Drain Efficiency	η <sub>D</sub>	32.0	36.5	—	%
Output Peak-to-Average Ratio @ 0.01% Probability on CCDF	PAR	7.2	7.8	—	dB
Adjacent Channel Power Ratio	ACPR	—	-32.2	-28.0	dBc

**Typical Broadband Performance** (6,8) (In Freescale Doherty Test Fixture, 50 ohm system) V<sub>DD</sub> = 28 Vdc, I<sub>DQA</sub> = 600 mA, V<sub>GGB</sub> = 1.2 Vdc, P<sub>out</sub> = 30 W Avg., Single-Carrier W-CDMA, IQ Magnitude Clipping, Input Signal PAR = 9.9 dB @ 0.01% Probability on CCDF. ACPR measured in 3.84 MHz Channel Bandwidth @ ±5 MHz Offset.

Frequency	G <sub>ps</sub> (dB)	η <sub>D</sub> (%)	Output PAR (dB)	ACPR (dBc)
2300 MHz	13.9	37.1	7.9	-31.0
2350 MHz	14.1	38.3	7.7	-32.2
2400 MHz	13.8	38.3	7.4	-33.1

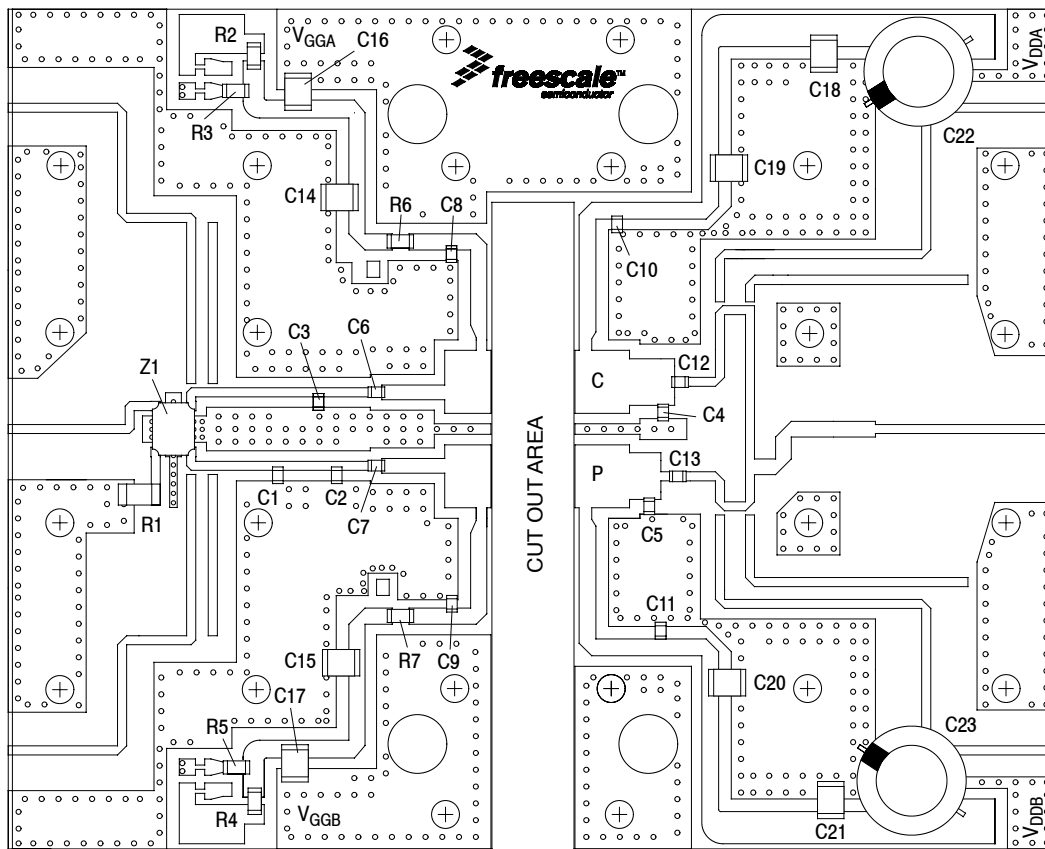
1. MTTF calculator available at <http://www.freescale.com/rf>. Select Software & Tools/Development Tools/Calculators to access MTTF calculators by product.
2. Refer to AN1955, *Thermal Measurement Methodology of RF Power Amplifiers*. Go to <http://www.freescale.com/rf>. Select Documentation/Application Notes - AN1955.
3. Exceeds recommended operating conditions. See CW operation data in Maximum Ratings table.
4. Each side of device measured separately.
5. V<sub>GG</sub> = 2.0 × V<sub>GSA(Q)</sub>. Parameter measured on Freescale Test Fixture, due to resistor divider network on the board. Refer to Test Fixture Layout.
6. V<sub>DDA</sub> and V<sub>ddb</sub> must be tied together and powered by a single DC power supply.
7. Part internally matched both on input and output.
8. Measurement made with device in a Symmetrical Doherty configuration

(continued)

**Table 4. Electrical Characteristics** ( $T_A = 25^\circ\text{C}$  unless otherwise noted) (continued)

Characteristic	Symbol	Min	Typ	Max	Unit
<b>Typical Performances</b> <sup>(1)</sup> (In Freescale Doherty Test Fixture, 50 ohm system) $V_{DD} = 28\text{ Vdc}$ , $I_{DQA} = 600\text{ mA}$ , $V_{GSB} = 1.2\text{ Vdc}$ , 2300–2400 MHz Bandwidth					
$P_{out}$ @ 1 dB Compression Point, CW	P1dB	—	150 <sup>(2)</sup>	—	W
$P_{out}$ @ 3 dB Compression Point <sup>(3)</sup>	P3dB	—	190	—	W
IMD Symmetry @ 28 W PEP, $P_{out}$ where IMD Third Order Intermodulation $\cong 30\text{ dBc}$ (Delta IMD Third Order Intermodulation between Upper and Lower Sidebands $> 2\text{ dB}$ )	IMD <sub>sym</sub>	—	102	—	MHz
VBW Resonance Point (IMD Third Order Intermodulation Inflection Point)	VBW <sub>res</sub>	—	150	—	MHz
Gain Flatness in 100 MHz Bandwidth @ $P_{out} = 30\text{ W Avg.}$	$G_F$	—	0.6	—	dB
Gain Variation over Temperature ( $-30^\circ\text{C}$ to $+85^\circ\text{C}$ )	$\Delta G$	—	0.015	—	dB/ $^\circ\text{C}$
Output Power Variation over Temperature ( $-30^\circ\text{C}$ to $+85^\circ\text{C}$ ) <sup>(2)</sup>	$\Delta P_{1dB}$	—	0.017	—	dB/ $^\circ\text{C}$

1. Measurement made with device in a Symmetrical Doherty configuration.
2. Exceeds recommended operating conditions. See CW operation data in Maximum Ratings table.
3.  $P_{3dB} = P_{avg} + 7.0\text{ dB}$  where  $P_{avg}$  is the average output power measured using an unclipped W-CDMA single-carrier input signal where output PAR is compressed to 7.0 dB @ 0.01% probability on CCDF.



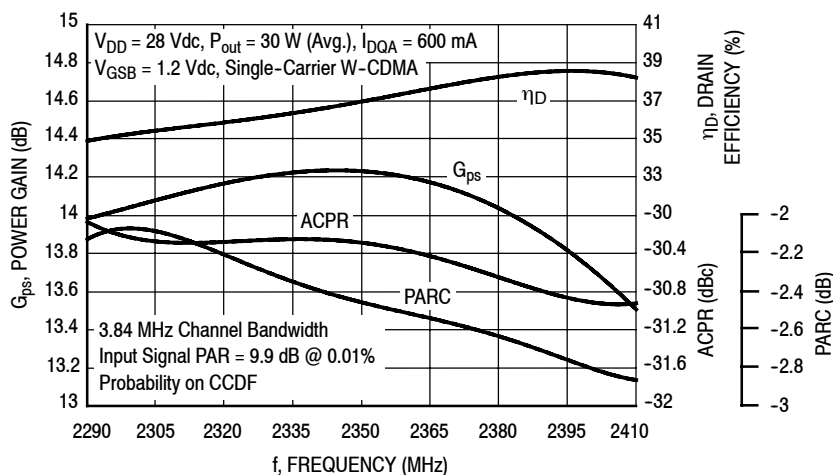
Note:  $V_{DDA}$  and  $V_{ddb}$  must be tied together and powered by a single DC power supply.

**Figure 2. MRF8P23160WHR3(WHSR3) Test Circuit Component Layout**

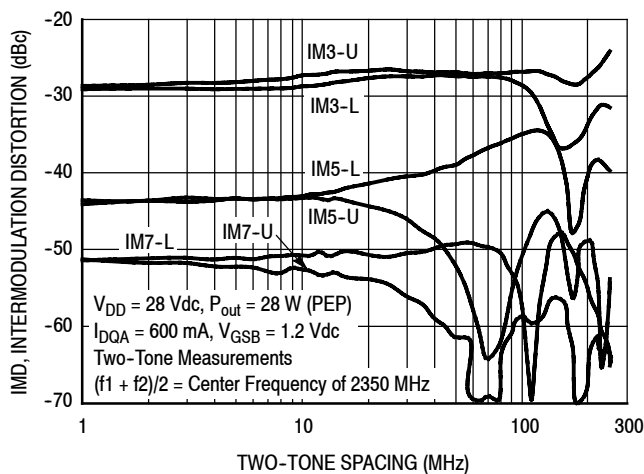
**Table 5. MRF8P23160WHR3(WHSR3) Test Circuit Component Designations and Values**

Part	Description	Part Number	Manufacturer
C1, C4, C5	0.2 pF Chip Capacitors	ATC600F0R2BT250XT	ATC
C2, C3	0.3 pF Chip Capacitors	ATC600F0R3BT250XT	ATC
C6	3.3 pF Chip Capacitor	ATC600F3R3BT250XT	ATC
C7	5.6 pF Chip Capacitor	ATC600F5R6BT250XT	ATC
C8, C9, C12, C13	6.8 pF Chip Capacitors	ATC600F6R8BT250XT	ATC
C10, C11	8.2 pF Chip Capacitors	ATC600F8R2BT250XT	ATC
C14, C15	330 nF, 50 V Chip Capacitors	C3225X7R2A334KT	TDK
C16, C17, C18, C19, C20, C21	10 $\mu$ F, 100 V Chip Capacitors	C3225X7R2A106KT	TDK
C22, C23	220 $\mu$ F, 100 V Electrolytic Capacitor	EEV-FK2A221M	Panasonic-ECG
R1	50 $\Omega$ , 10 W Chip Resistor	CW12010T0050GBK	ATC
R2, R3, R4, R5	390 $\Omega$ , 1/4 W Chip Resistors	CRCW1206390FKEA	Vishay
R6, R7	4.75 $\Omega$ , 1/4 W Chip Resistors	CRCW12064R75FKEA	Vishay
Z1	2300–2700 MHz 90°, 3 dB Chip Hybrid Coupler	1P603S	Anaren
PCB	0.020", $\epsilon_r = 3.5$	RF35A2	Taconic

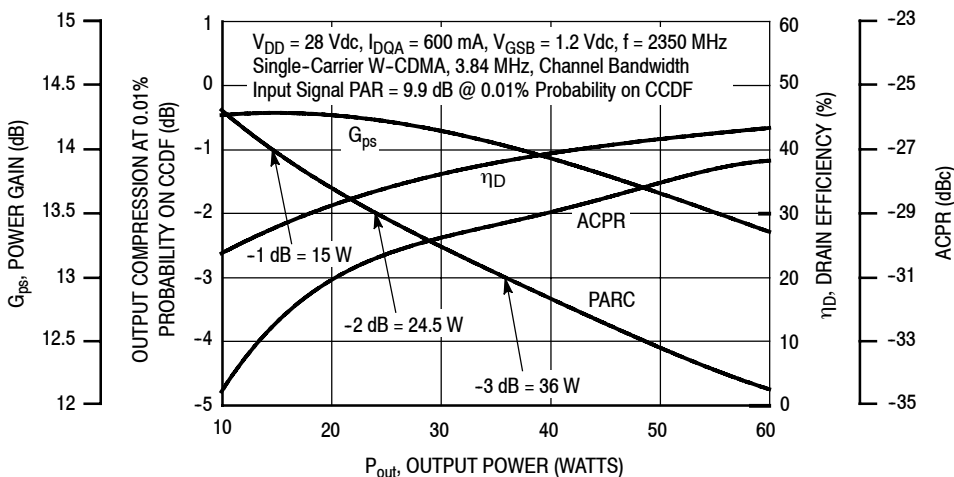
### TYPICAL CHARACTERISTICS



**Figure 3. Single-Carrier Output Peak-to-Average Ratio Compression (PARC) Broadband Performance @  $P_{out} = 30$  Watts Avg.**

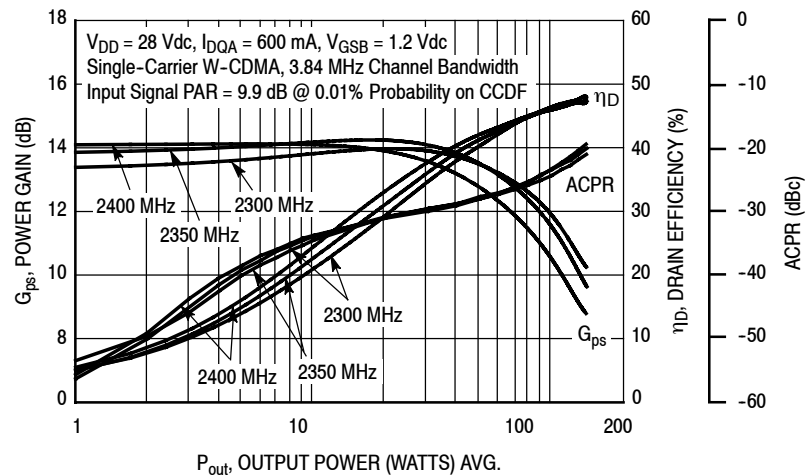


**Figure 4. Intermodulation Distortion Products versus Two-Tone Spacing**

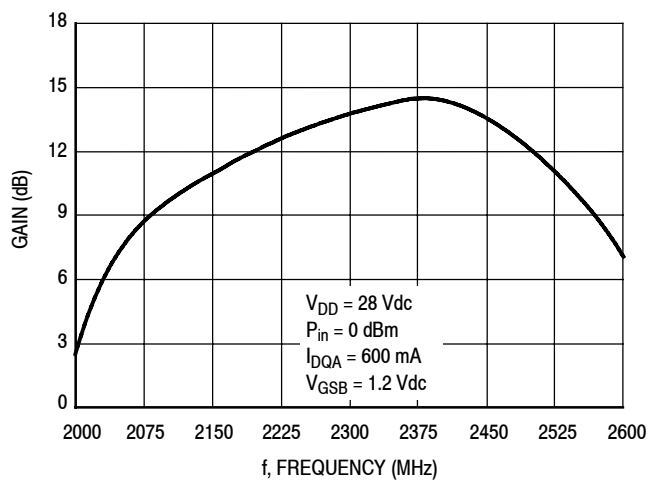


**Figure 5. Output Peak-to-Average Ratio Compression (PARC) versus Output Power**

### TYPICAL CHARACTERISTICS

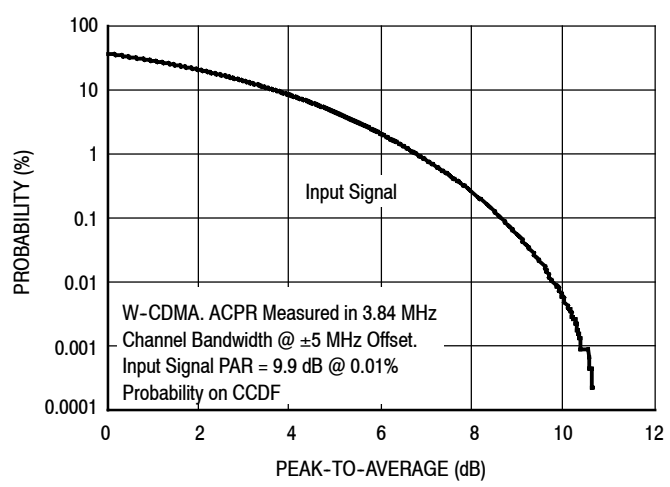


**Figure 6. Single-Carrier W-CDMA Power Gain, Drain Efficiency and ACPR versus Output Power**

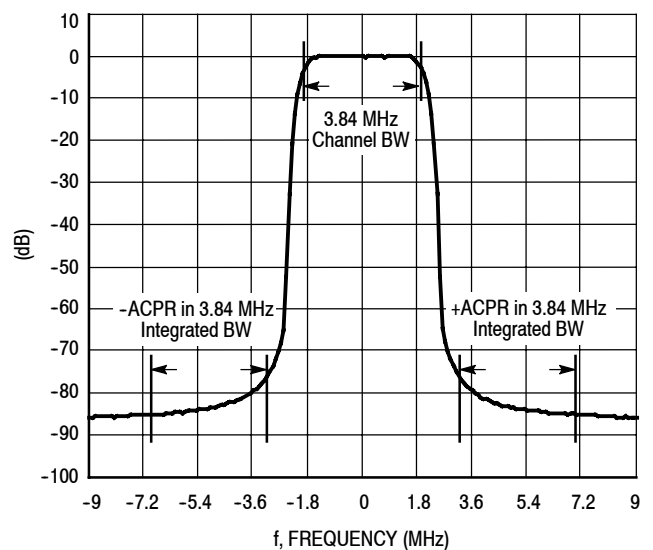


**Figure 7. Broadband Frequency Response**

### W-CDMA TEST SIGNAL



**Figure 8. CCDF W-CDMA IQ Magnitude Clipping, Single-Carrier Test Signal**



**Figure 9. Single-Carrier W-CDMA Spectrum**

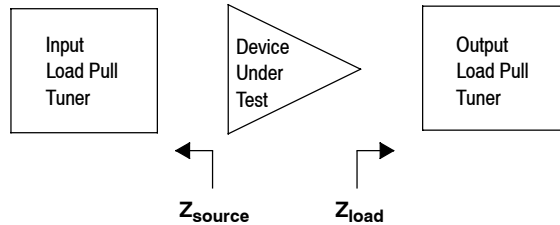
$V_{DD} = 28 \text{ Vdc}$ ,  $I_{DQA} = 600 \text{ mA}$ , Pulsed CW, 10  $\mu\text{sec}(\text{on})$ , 10% Duty Cycle

f (MHz)	$Z_{\text{source}}$ ( $\Omega$ )	$Z_{\text{load}}^{(1)}$ ( $\Omega$ )	Max Output Power					
			P1dB			P3dB		
			(dBm)	(W)	$\eta_D$ (%)	(dBm)	(W)	$\eta_D$ (%)
2300	15.8 - j13.8	5.58 - j10.3	49.8	95	47.6	50.8	121	57.1
2350	19.8 - j7.63	5.70 - j10.4	49.7	93	48.2	50.7	119	56.1
2400	16.0 + j0.38	5.96 - j10.5	49.7	92	49.0	50.7	118	55.8

(1) Load impedance for optimum P1dB power.

$Z_{\text{source}}$  = Impedance as measured from gate contact to ground.

$Z_{\text{load}}$  = Impedance as measured from drain contact to ground.



**Figure 10. Carrier Side Load Pull Performance — Maximum P1dB Tuning**

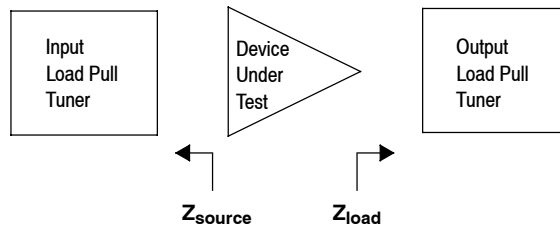
$V_{DD} = 28 \text{ Vdc}$ ,  $I_{DQA} = 600 \text{ mA}$ , Pulsed CW, 10  $\mu\text{sec}(\text{on})$ , 10% Duty Cycle

f (MHz)	$Z_{\text{source}}$ ( $\Omega$ )	$Z_{\text{load}}^{(1)}$ ( $\Omega$ )	Max Drain Efficiency					
			P1dB			P3dB		
			(dBm)	(W)	$\eta_D$ (%)	(dBm)	(W)	$\eta_D$ (%)
2300	15.8 - j13.8	6.54 - 4.70	48.3	67	57.1	49.6	91	59.4
2350	19.8 - j7.63	5.70 - 5.65	48.3	68	56.1	49.4	86	58.5
2400	16.0 + j0.38	5.50 - 6.23	48.3	68	55.8	49.7	92	58.0

(1) Load impedance for optimum P1dB efficiency.

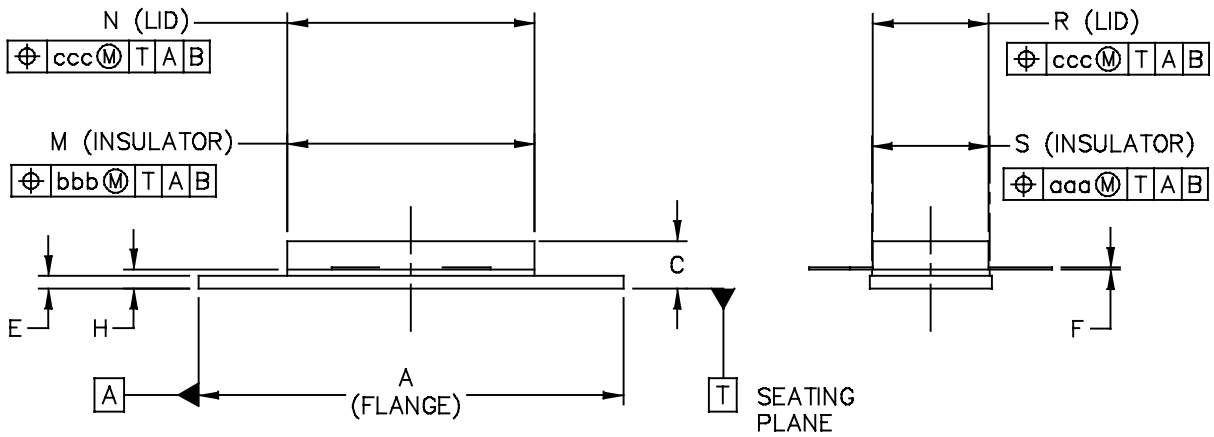
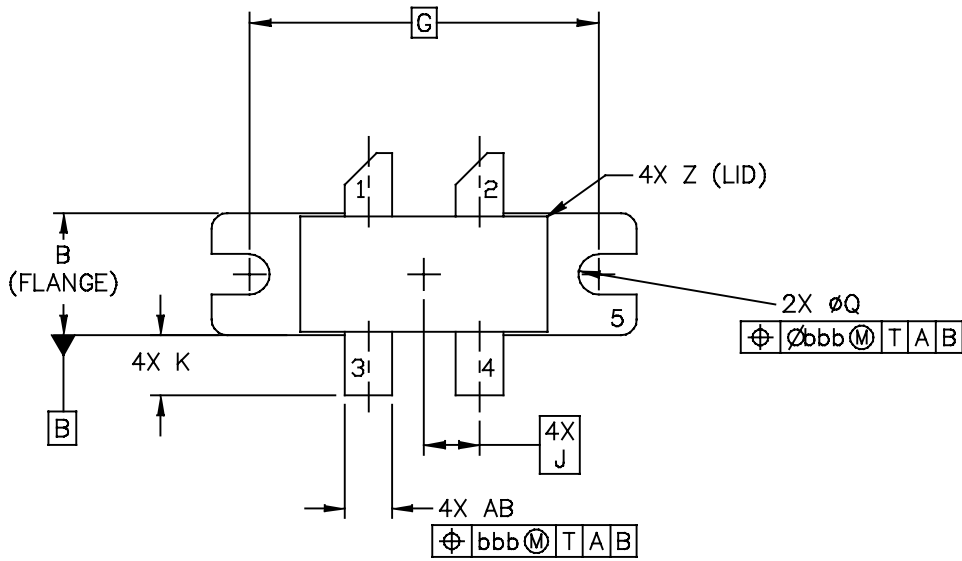
$Z_{\text{source}}$  = Impedance as measured from gate contact to ground.

$Z_{\text{load}}$  = Impedance as measured from drain contact to ground.



**Figure 11. Carrier Side Load Pull Performance — Maximum Drain Efficiency Tuning**

### PACKAGE DIMENSIONS



© FREESCALE SEMICONDUCTOR, INC. ALL RIGHTS RESERVED.	MECHANICAL OUTLINE	PRINT VERSION NOT TO SCALE	
TITLE:  NI 780-4	DOCUMENT NO: 98ASA10793D		REV: 0
	CASE NUMBER: 465M-01		27 MAR 2007
	STANDARD: NON-JEDEC		



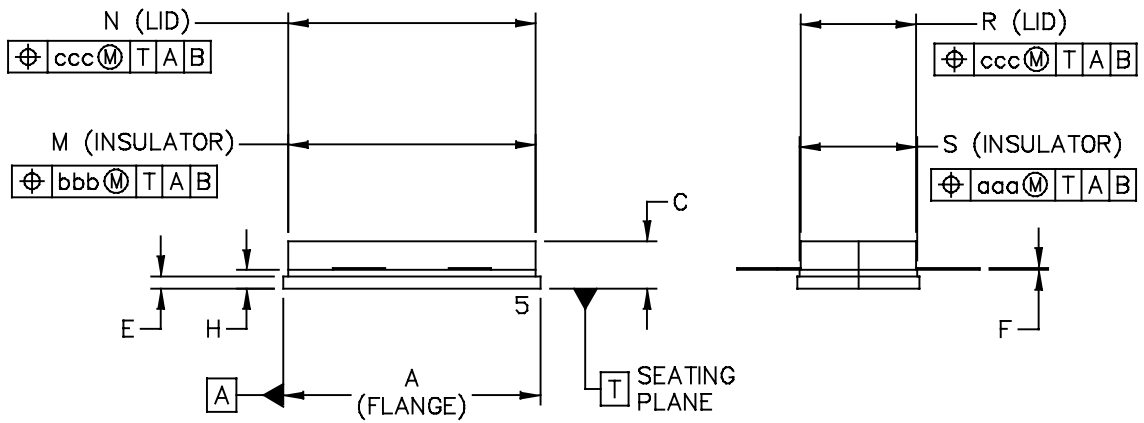
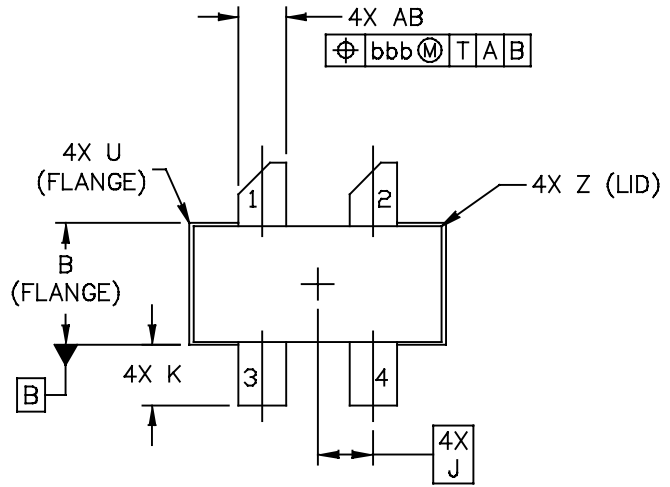
NOTES:

1. DIMENSIONING AND TOLERANCING PER ANSI Y14.5M-1994.
2. CONTROLLING DIMENSION: INCH.
3. DIMENSION H IS MEASURED .030 (0.762) AWAY FROM PACKAGE BODY.

STYLE 1:

- PIN 1. DRAIN  
 2. DRAIN  
 3. GATE  
 4. GATE  
 5. SOURCE

DIM	INCH		MILLIMETER		DIM	INCH		MILLIMETER	
	MIN	MAX	MIN	MAX		MIN	MAX	MIN	MAX
A	1.335	1.345	33.91	34.16	R	.365	.375	9.27	9.53
B	.380	.390	9.65	9.91	S	.365	.375	9.27	9.52
C	.125	.170	3.18	4.32	U		.040		1.02
E	.035	.045	0.89	1.14	Z		.030		0.76
F	.003	.006	0.08	0.15	AB	.145	.155	3.68	3.94
G	1.100 BSC		27.94 BSC						
H	.057	.067	1.45	1.7	aaa		.005		0.127
J	.175 BSC		4.44 BSC		bbb		.010		0.254
K	.170	.210	4.32	5.33	ccc		.015		0.381
M	.774	.786	19.61	20.02					
N	.772	.788	19.61	20.02					
Q	Ø.118	Ø.138	Ø3	Ø3.51					
© FREESCALE SEMICONDUCTOR, INC. ALL RIGHTS RESERVED.			MECHANICAL OUTLINE			PRINT VERSION NOT TO SCALE			
TITLE:  NI 780-4					DOCUMENT NO: 98ASA10793D			REV: 0	
					CASE NUMBER: 465M-01			27 MAR 2007	
					STANDARD: NON-JEDEC				



© FREESCALE SEMICONDUCTOR, INC. ALL RIGHTS RESERVED.	MECHANICAL OUTLINE	PRINT VERSION NOT TO SCALE	
TITLE:  NI 780S-4	DOCUMENT NO: 98ASA10718D	REV: A	
	CASE NUMBER: 465H-02	27 MAR 2007	
	STANDARD: NON-JEDEC		



NOTES:

1. DIMENSIONING AND TOLERANCING PER ANSI Y14.5M-1994.
2. CONTROLLING DIMENSION: INCH.
3. DELETED
4. DIMENSION H IS MEASURED .030 (0.762) AWAY FROM PACKAGE BODY.

STYLE 1:

- PIN 1. DRAIN
2. DRAIN
3. GATE
4. GATE
5. SOURCE

DIM	INCH		MILLIMETER		DIM	INCH		MILLIMETER	
	MIN	MAX	MIN	MAX		MIN	MAX	MIN	MAX
A	.805	.815	20.45	20.7	U		.040		1.02
B	.380	.390	9.65	9.91	Z		.030		0.76
C	.125	.170	3.18	4.32	AB	.145	.155	3.68	– 3.94
E	.035	.045	0.89	1.14					
F	.003	.006	0.08	0.15	aaa		.005		0.127
H	.057	.067	1.45	1.7	bbb		.010		0.254
J	.175 BSC		4.44 BSC		ccc		.015		0.381
K	.170	.210	4.32	5.33					
M	.774	.786	19.61	20.02					
N	.772	.788	19.61	20.02					
R	.365	.375	9.27	9.53					
S	.365	.375	9.27	9.52					
© FREESCALE SEMICONDUCTOR, INC. ALL RIGHTS RESERVED.			MECHANICAL OUTLINE			PRINT VERSION NOT TO SCALE			
TITLE:  NI 780S-4					DOCUMENT NO: 98ASA10718D			REV: A	
					CASE NUMBER: 465H-02			27 MAR 2007	
					STANDARD: NON-JEDEC				

## PRODUCT DOCUMENTATION, SOFTWARE AND TOOLS

Refer to the following documents, software and tools to aid your design process.

### Application Notes

- AN1955: Thermal Measurement Methodology of RF Power Amplifiers

### Engineering Bulletins

- EB212: Using Data Sheet Impedances for RF LDMOS Devices

### Software

- Electromigration MTTF Calculator
- RF High Power Model
- .s2p File

For Software and Tools, do a Part Number search at <http://www.freescale.com>, and select the “Part Number” link. Go to the Software & Tools tab on the part’s Product Summary page to download the respective tool.

## R5 TAPE AND REEL OPTION

R5 Suffix = 50 Units, 56 mm Tape Width, 13 inch Reel.

The R5 tape and reel option for MRF8P23160WH and MRF8P23160WHS parts will be available for 2 years after release of MRF8P23160WH and MRF8P23160WHS. Freescale Semiconductor, Inc. reserves the right to limit the quantities that will be delivered in the R5 tape and reel option. At the end of the 2 year period customers who have purchased these devices in the R5 tape and reel option will be offered MRF8P23160WH and MRF8P23160WHS in the R3 tape and reel option.

## REVISION HISTORY

The following table summarizes revisions to this document.

Revision	Date	Description
0	Dec. 2011	• Initial Release of Data Sheet

## **How to Reach Us:**

### **Home Page:**

[www.freescale.com](http://www.freescale.com)

### **Web Support:**

<http://www.freescale.com/support>

### **USA/Europe or Locations Not Listed:**

Freescale Semiconductor, Inc.  
Technical Information Center, EL516  
2100 East Elliot Road  
Tempe, Arizona 85284  
1-800-521-6274 or +1-480-768-2130  
[www.freescale.com/support](http://www.freescale.com/support)

### **Europe, Middle East, and Africa:**

Freescale Halbleiter Deutschland GmbH  
Technical Information Center  
Schatzbogen 7  
81829 Muenchen, Germany  
+44 1296 380 456 (English)  
+46 8 52200080 (English)  
+49 89 92103 559 (German)  
+33 1 69 35 48 48 (French)  
[www.freescale.com/support](http://www.freescale.com/support)

### **Japan:**

Freescale Semiconductor Japan Ltd.  
Headquarters  
ARCO Tower 15F  
1-8-1, Shimo-Meguro, Meguro-ku,  
Tokyo 153-0064  
Japan  
0120 191014 or +81 3 5437 9125  
[support.japan@freescale.com](mailto:support.japan@freescale.com)

### **Asia/Pacific:**

Freescale Semiconductor China Ltd.  
Exchange Building 23F  
No. 118 Jianguo Road  
Chaoyang District  
Beijing 100022  
China  
+86 10 5879 8000  
[support.asia@freescale.com](mailto:support.asia@freescale.com)

### **For Literature Requests Only:**

Freescale Semiconductor Literature Distribution Center  
1-800-441-2447 or +1-303-675-2140  
Fax: +1-303-675-2150  
[LDCForFreescaleSemiconductor@hibbertgroup.com](mailto:LDCForFreescaleSemiconductor@hibbertgroup.com)

Information in this document is provided solely to enable system and software implementers to use Freescale Semiconductor products. There are no express or implied copyright licenses granted hereunder to design or fabricate any integrated circuits or integrated circuits based on the information in this document.

Freescale Semiconductor reserves the right to make changes without further notice to any products herein. Freescale Semiconductor makes no warranty, representation or guarantee regarding the suitability of its products for any particular purpose, nor does Freescale Semiconductor assume any liability arising out of the application or use of any product or circuit, and specifically disclaims any and all liability, including without limitation consequential or incidental damages. "Typical" parameters that may be provided in Freescale Semiconductor data sheets and/or specifications can and do vary in different applications and actual performance may vary over time. All operating parameters, including "Typicals", must be validated for each customer application by customer's technical experts. Freescale Semiconductor does not convey any license under its patent rights nor the rights of others. Freescale Semiconductor products are not designed, intended, or authorized for use as components in systems intended for surgical implant into the body, or other applications intended to support or sustain life, or for any other application in which the failure of the Freescale Semiconductor product could create a situation where personal injury or death may occur. Should Buyer purchase or use Freescale Semiconductor products for any such unintended or unauthorized application, Buyer shall indemnify and hold Freescale Semiconductor and its officers, employees, subsidiaries, affiliates, and distributors harmless against all claims, costs, damages, and expenses, and reasonable attorney fees arising out of, directly or indirectly, any claim of personal injury or death associated with such unintended or unauthorized use, even if such claim alleges that Freescale Semiconductor was negligent regarding the design or manufacture of the part.

Freescale™ and the Freescale logo are trademarks of Freescale Semiconductor, Inc. All other product or service names are the property of their respective owners.

© Freescale Semiconductor, Inc. 2011. All rights reserved.