

Powerex, Inc., 200 Hillis Street, Youngwood, Pennsylvania 15697-1800 (412) 925-7272
 Powerex, Europe, S.A. 428 Avenue G. Durand, BP107, 72003 Le Mans, France (43) 41.14.14

Phase Control SCR
 590 Amperes Average
 1200 Volts

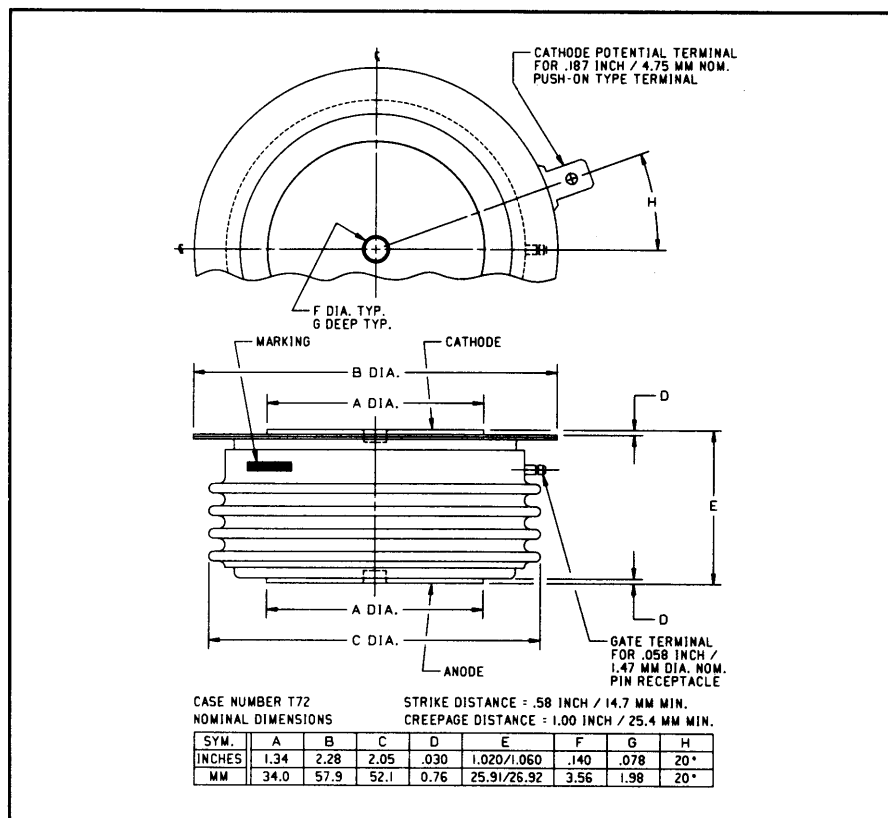

C390__X555 (Outline Drawing)

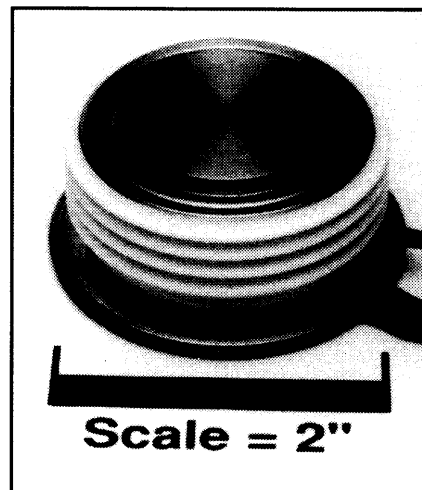

C390__X555 Phase Control SCR
 590 Amperes Average, 1200 Volts

Description:

Powerex Silicon Controlled Rectifiers (SCR) are designed for phase control applications. These are all-diffused, Press-Pak (Pow-R-Disc) devices employing the field-proven amplifying (di/namic) gate.

Features:

- Low On-State Voltage
- High di/dt
- High dv/dt
- Hermetic Packaging
- Excellent Surge and I^2t Ratings
- High Temperature Operation

Applications:

- Power Supplies
- Battery Chargers
- Motor Control

Ordering Information:

Select the complete nine or ten digit part number you desire from the table, i.e. C390PBX555 is a 1200 Volt, 590 Ampere Phase Control SCR.

Type	Voltage		Current
	V_{DRM} V_{RRM}	Code	$I_T(av)$
C390__X555	600	M	590
	800	N	
	1000	P	
	1200	PB	



Powerex, Inc., 200 Hillis Street, Youngwood, Pennsylvania 15697-1800 (412) 925-7272
 Powerex, Europe, S.A. 428 Avenue G. Durand, BP107, 72003 Le Mans, France (43) 41.14.14

C390_X555
 Phase Control SCR
 590 Amperes Average, 1200 Volts

Absolute Maximum Ratings

	Symbol	C390_X555	Units
RMS On-State Current @ $T_C = 80^\circ\text{C}$	$I_{T(RMS)}$	925	Amperes
Average On-State Current @ $T_C = 80^\circ\text{C}$	$I_{T(av)}$	590	Amperes
Peak One-Cycle Surge (Non-Repetitive) On-State Current (60Hz)	I_{TSM}	8000	Amperes
Peak One-Cycle Surge (Non-Repetitive) On-State Current (50Hz)	I_{TSM}	7600	Amperes
Critical Rate-of-Rise of On-State Current (Non-Repetitive)	di/dt	800	Amperes/ μs
Critical Rate-of-Rise of On-State Current (Repetitive)	di/dt	500	Amperes/ μs
I^2t (for Fusing), One Cycle at 60Hz	I^2t	266,500	A^2sec
Peak Gate Power Dissipation	P_{GM}	200	Watts
Average Gate Power Dissipation	$P_{G(av)}$	5	Watts
Storage Temperature	T_{STG}	-40 to 150	$^\circ\text{C}$
Operating Temperature	T_J	-40 to 150	$^\circ\text{C}$
Mounting Force		1800 to 2200	lb.
Mounting Force		8 to 9.8	kN

Electrical and Thermal Characteristics

Characteristics	Symbol	Test Conditions	C390_X555	Units
Voltage—Blocking State Maximums				
Forward Leakage, Peak	I_{DRM}	$T_J = 150^\circ\text{C}$, rated V_{DRM}	65	mA
Reverse Leakage, Peak	I_{RRM}	$T_J = 150^\circ\text{C}$, rated V_{RRM}	65	mA
Current—Conducting State Maximums				
Peak On-State Voltage	V_{TM}	$I_{TM} = 3000\text{A}$, $T_J = 25^\circ\text{C}$	2.6	Volts
Switching				
Typical Turn-Off Time	t_q	$T_J = 150^\circ\text{C}$; $I_{TM} = 50$ Amps; $V_R = 50$ Volts Min.; V_{DRM} (Reapplied); Rate-of-Rise of Reapplied Off-State Voltage = $20\text{V}/\mu\text{sec}$ (linear); Commutation $di/dt = 25$ Amps/ μsec ; Repetition Rate = 1 pps; Gate Bias During Turn-Off Interval = 0 Volts, 100Ω	200	μsec
Min. Critical dv/dt exponential to V_{DRM}	dv/dt	$T_J = 150^\circ\text{C}$, Gate Open	200	$\text{V}/\mu\text{sec}$
Thermal				
Maximum Thermal Resistance, double sided cooling				
Junction to Case	$R_{\theta JC}$		0.06	$^\circ\text{C}/\text{Watt}$
Case to Sink, Lubricated	$R_{\theta CS}$		0.02	$^\circ\text{C}/\text{Watt}$
Gate—Maximum Parameters				
Gate Current to Trigger	I_{GT}	$T_J = 25^\circ\text{C}$, $V_D = 6\text{Vdc}$, $R_L = 3\Omega$	150	mA
Gate Voltage to Trigger	V_{GT}	$T_J = -40^\circ\text{C}$ to 150°C , $V_D = 6\text{Vdc}$, $R_L = 3\Omega$	5	Volts
Non-Triggering Gate Voltage	V_{GDM}	$T_J = 150^\circ\text{C}$, $V_D = \text{Rated } V_{DRM}$, $R_L = 1000\Omega$	0.15	Volts
Peak Forward Gate Current	I_{GTM}		10	Amperes
Peak Reverse Gate Voltage	V_{GRM}		5	Volts

Powerex, Inc., 200 Hillis Street, Youngwood, Pennsylvania 15697-1800 (412) 925-7272
 Powerex, Europe, S.A. 428 Avenue G. Durand, BP107, 72003 Le Mans, France (43) 41.14.14

C390_X555
 Phase Control SCR
 590 Amperes Average, 1200 Volts

MAXIMUM ON-STATE CHARACTERISTICS

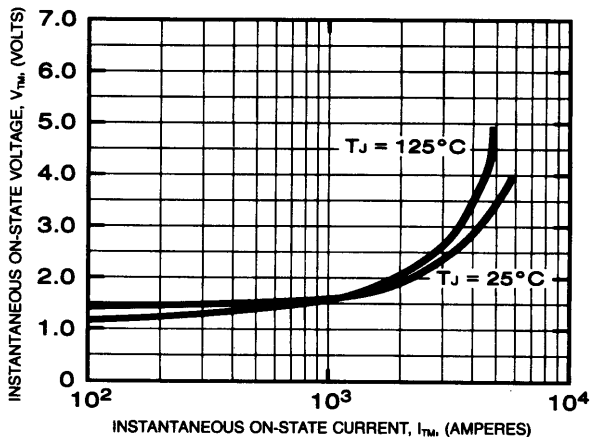

TRANSIENT THERMAL IMPEDANCE CHARACTERISTICS (JUNCTION TO CASE)

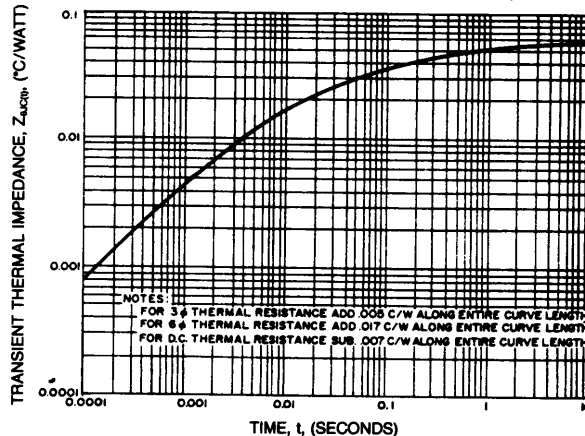

MAXIMUM ALLOWABLE CASE TEMPERATURE (SINUSOIDAL WAVEFORM)

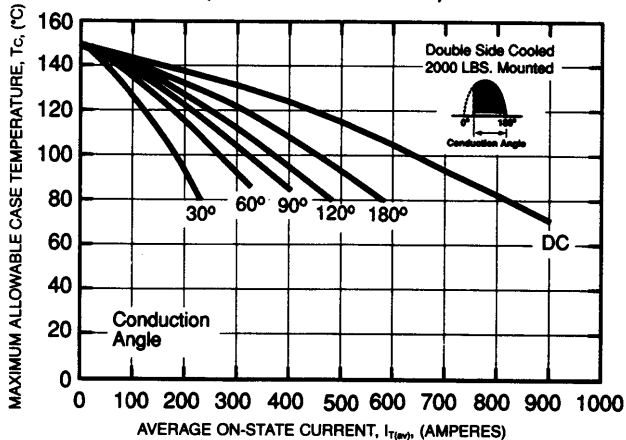

MAXIMUM ON-STATE POWER DISSIPATION (SINUSOIDAL WAVEFORM)

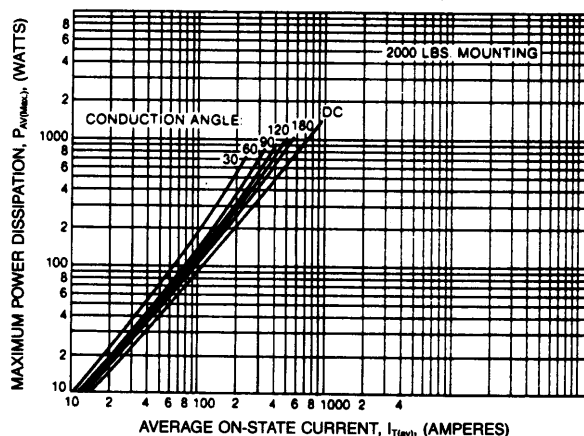

MAXIMUM ALLOWABLE CASE TEMPERATURE (RECTANGULAR WAVEFORM)

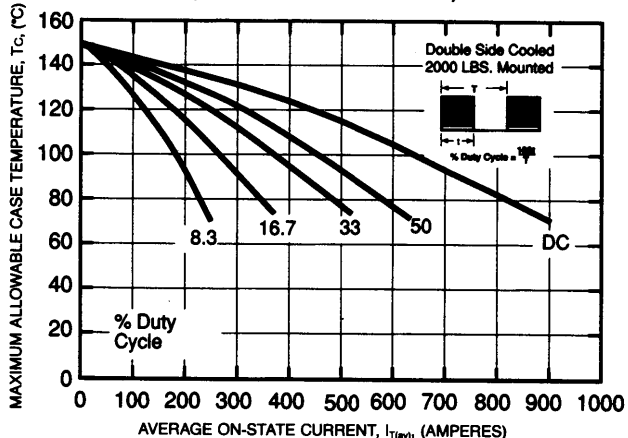

MAXIMUM ON-STATE POWER DISSIPATION (RECTANGULAR WAVEFORM)

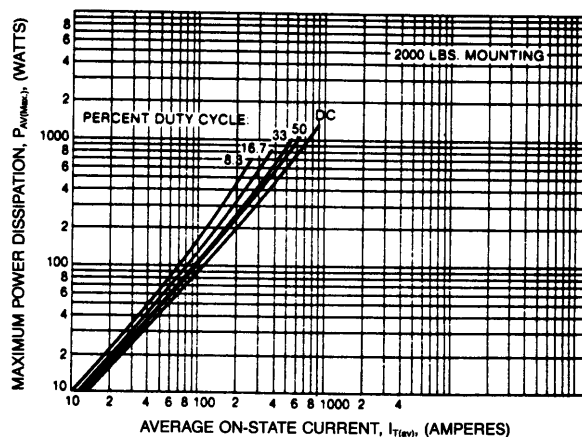

Powerex, Inc., 200 Hillis Street, Youngwood, Pennsylvania 15697-1800 (412) 925-7272
 Powerex, Europe, S.A. 428 Avenue G. Durand, BP107, 72003 Le Mans, France (43) 41.14.14

C390_X555

Phase Control SCR

590 Amperes Average, 1200 Volts

MAXIMUM ALLOWABLE CASE TEMPERATURE
(SINUSOIDAL WAVEFORM)

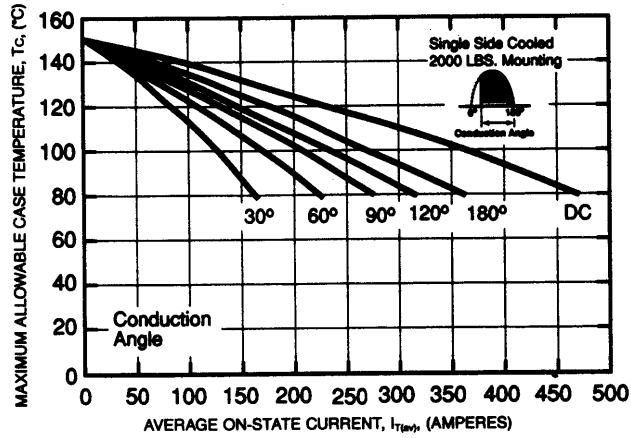

MAXIMUM ALLOWABLE CASE TEMPERATURE
(RECTANGULAR WAVEFORM)

