

PART NO.
DWG. NO.

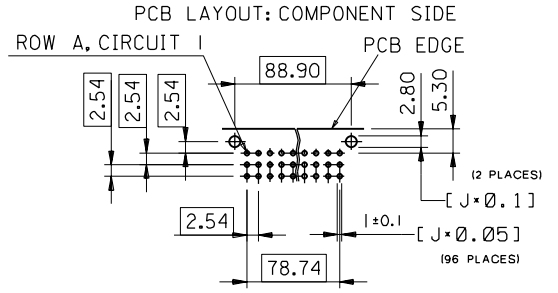

1) tails to fit in PC-board layout

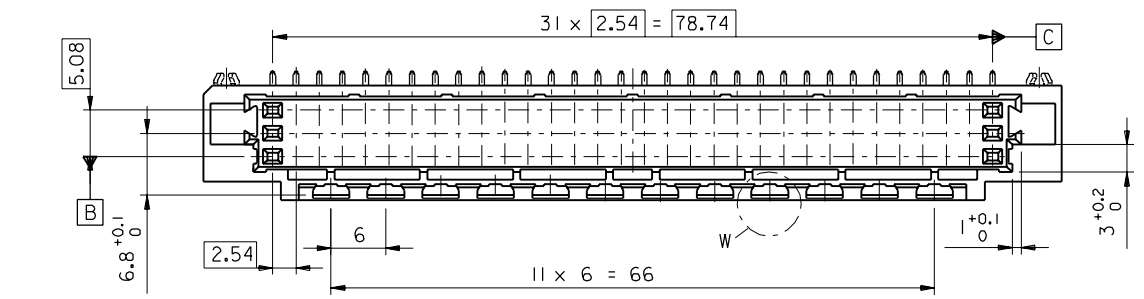
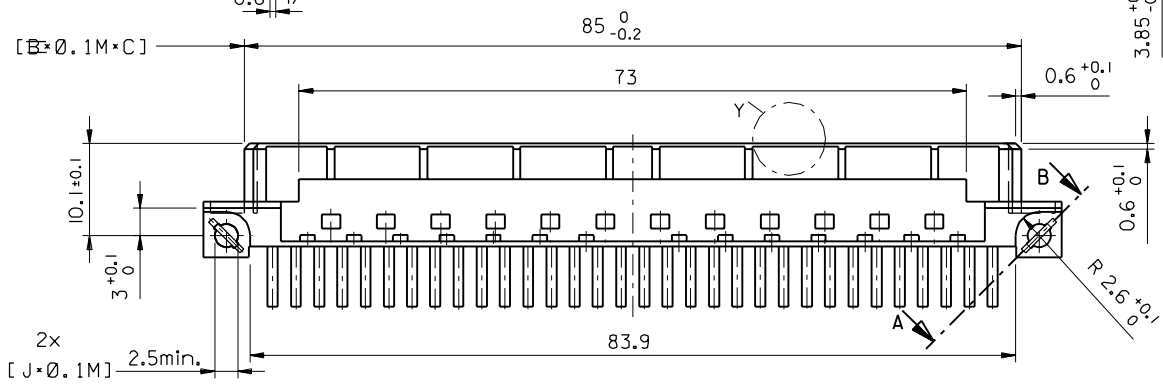
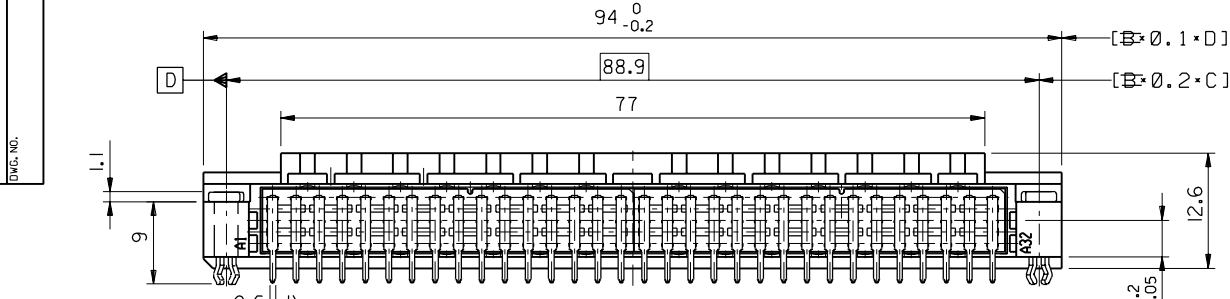
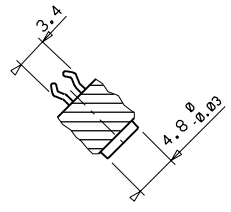
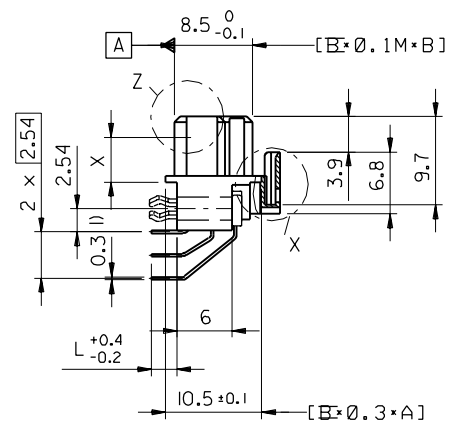

Section A - B

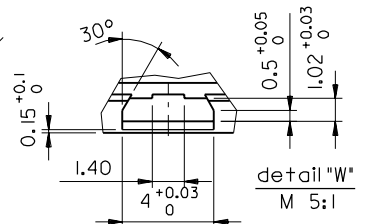

detail "W"
M 5:1

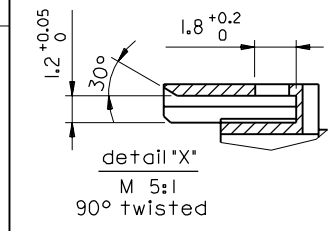

detail "X"
M 5:1
90° twisted

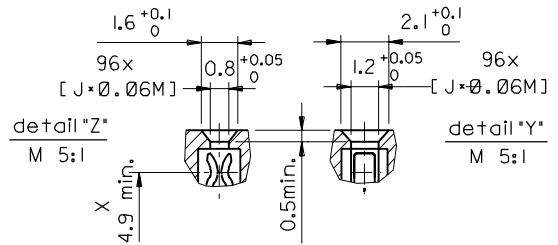

detail "Z"
M 5:1

detail "Y"
M 5:1

FIRST ANGLE PROJECTION

REVISIONS	3 PLACE ±	±
	2 PLACE ±	±
	1 PLACE ±	±
	DRAFT WHERE APPLICABLE MUST REMAIN WITHIN DIMENSIONS	
DESIGN DIMENSION	<input checked="" type="checkbox"/> MM	<input type="checkbox"/> IN.
EQUIVALENT DIMENSION	<input type="checkbox"/> MM	<input type="checkbox"/> IN.
IF TWO DIMENSIONS ARE SHOWN THE UPPER IS THE DESIGN DIMENSION, LOWER IS SECONDARY		

DRWG BY	KN	SIGN
CHK'D BY	Ca	SIGN
APP'D BY	JB	SIGN
SCALE	2:1	

REVISE ONLY ON CAD SYSTEM

SH.	REV.
CAD/CAM PROJECT NAME 85052000 s12	
THIS DRAWING CONTAINS INFORMATION THAT IS PROPRIETARY TO MOLEX INC. & SHOULD NOT BE USED WITHOUT WRITTEN PERMISSION	
TITLE 96 pos. female connector DIN 41612 style Q,+ clip with coding, dimensions	
MOLEX MOLEX EUROPE	
SHEET NO. DATE 2 OF 2 96/04/30	
PART NO.	DWG NO.
SDA-85052-0001	SIZE B

