

order number	lens name
0703-116-000-21	inspec.x L float 5.6/120

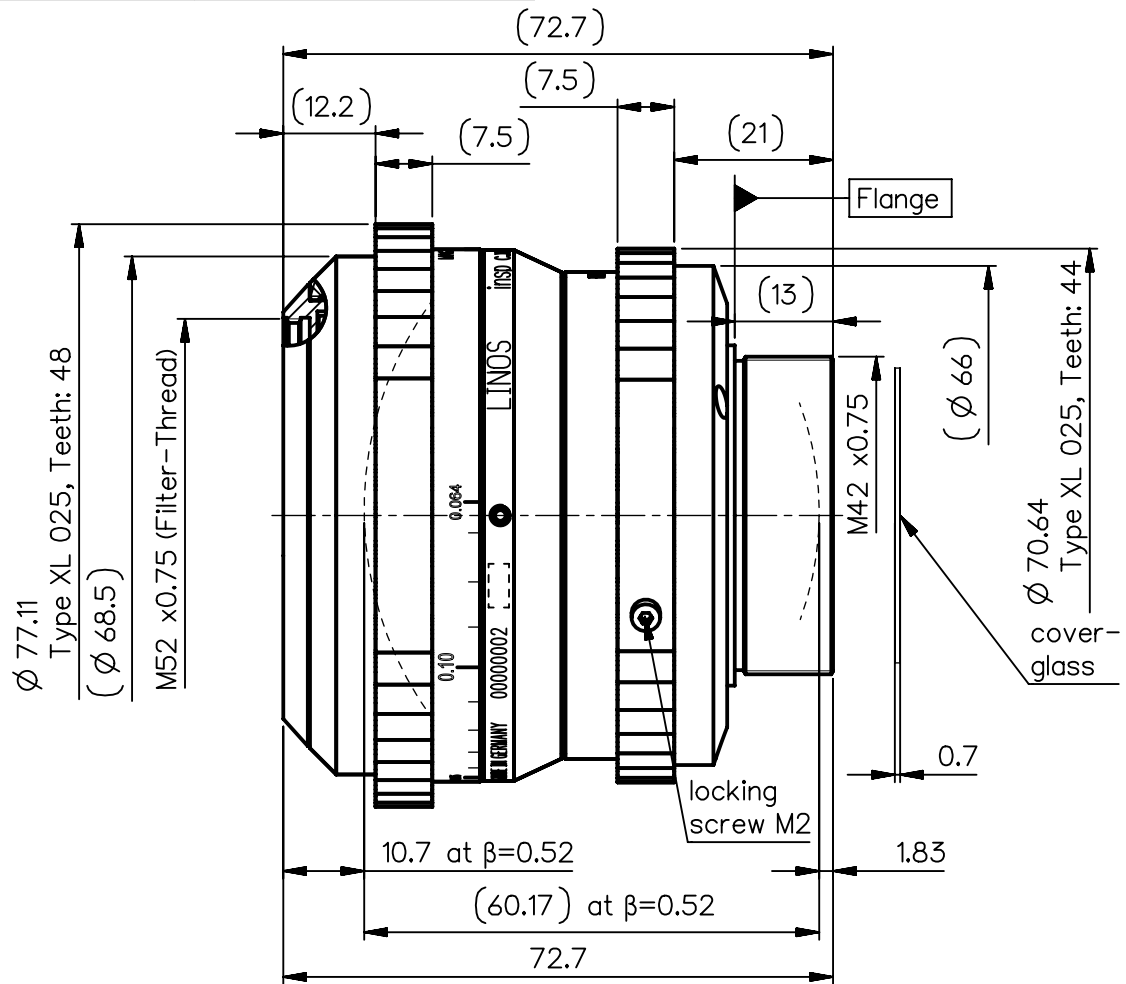

Specification		ON	7608-9121		
image circle max. (mm)	82	working distance (mm)	302.1 - 2037.3		
focal length f' (mm)	121.7	interface	M42x0.75		
magnification β' [range]	-0.14 [-0.06 ... -0.52]	filter thread	M52x0.75		
spectral range λ (nm)	400 - 750	weight (g)	570g		
schematic diagram		design includes CCD cover glass: yes 0.7mm N-ZK7			
		SF (mm)	-69.2	f-stop	5.6
		S'F' (mm) *	-6.5	Ø EnP	20.8
		HH' (mm) *	-13.53	Ø Exp	21.2
		SH (mm)	52.5		
		S'H' (mm) *	-128.2		
		S'EnP (mm)	50.0		
		S'Exp (mm) *	-130.7		

Schutzvermerk "DIN ISO 16016" beachten	EU-D	AL-T1A	US-D	US-ML	not export controlled
	Rev. a	Aenderung Neuausg	Datum 21.02.19	Freigabe Kuehne	PDM-Status Freigabe
	zul. Abweichung für Mass, Form & Lage ISO 2768-mH				Maßstab 1:1
	Tolerierung ISO 8015				Werkstoff
DIN A 4	Ersterstellung 21.02.19 Kuehne				Benennung inspec.x L float 5.6/120
	Prüfung 21.02.19 Ulmer				
	Zeichnungsnummer 0703-116-100-21-0001a				
Alle Maße in mm, inklusive Oberflächenbehandlung				Blatt 1 von 2	
				Ersatz für	

β'	recommended f-stop	angle	f'	HH' (in air)	working distance	Flange - Image (in air)
stop		278.5				
-0,06	8.4	274,9	122,2	-14,1	2037,3	105,5
-0,14	7.8	198,4	121,7	-13,5	940,7	115,4
-0,3	6.9	93,4	121	-12,5	474,6	135,3
-0,52	5.6	0	120,4	-11,5	302,1	162
stop		-3.6				

Working and flange focal distances for different magnifications

Zaehnezahl: 48
Teilung: Type XL 025 (1/5" (=5.08mm))

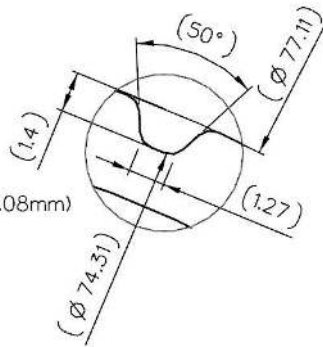

Zaehnezahl: 44
Teilung: Type XL 025 (1/5" (=5.08mm))

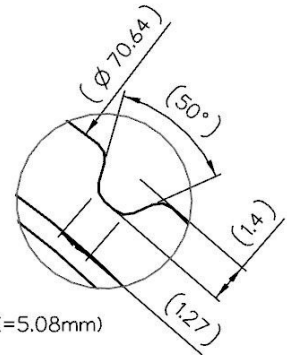

NX	EU-D		AL-T1A		US-D		US-ML		not export controlled		
							PDM-Status Freigabe		-		
Schutzvermerk "DIN ISO 16016" beachten	Rev.	Aenderung	Datum	Freigabe	zul. Abweichung für Mass, Form & Lage ISO 2768-mH	Oberfläche	Maßstab -		Benennung inspec.x L float 5.6/120		
	a	Neuausg	04.09.19	Kuehne			Werkstoff				
					Tolerierung ISO 8015						
					Erster- stellung	Datum	Name				
					Prüfung	04.09.19	Kuehne				
DIN A 4	Alle Maße in mm, inklusive Oberflächenbehandlung						Zeichnungsnummer 0703-116-100-21-0002a		Blatt 2 von 2		
	Ersatz für										

inspec.x_L_5.6/120_float

MTF at ratio -0.06 f/ 8.4

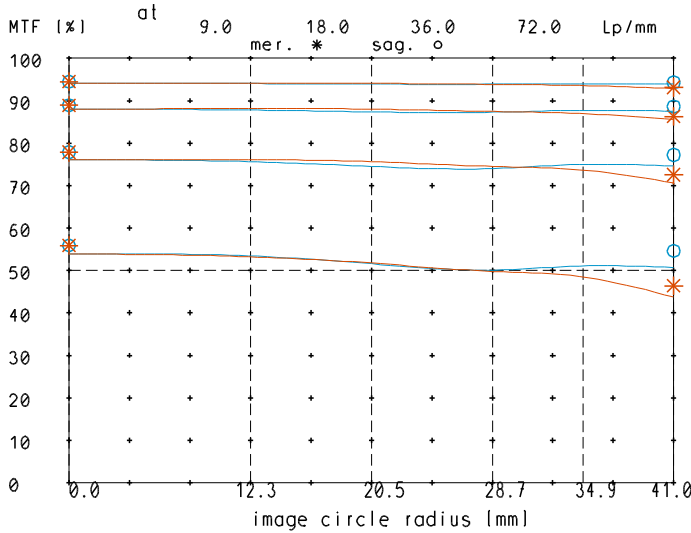

relative light fall-off at ratio -0.06

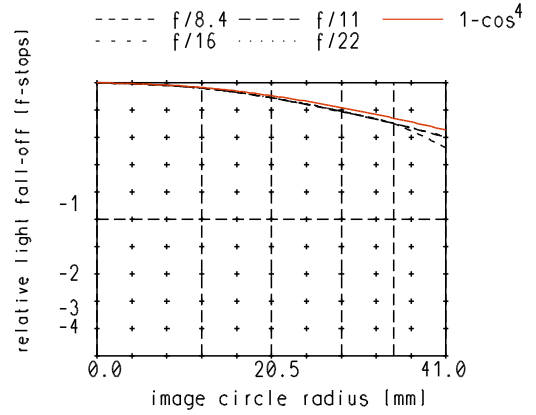

MTF at ratio -0.06 f/ 11

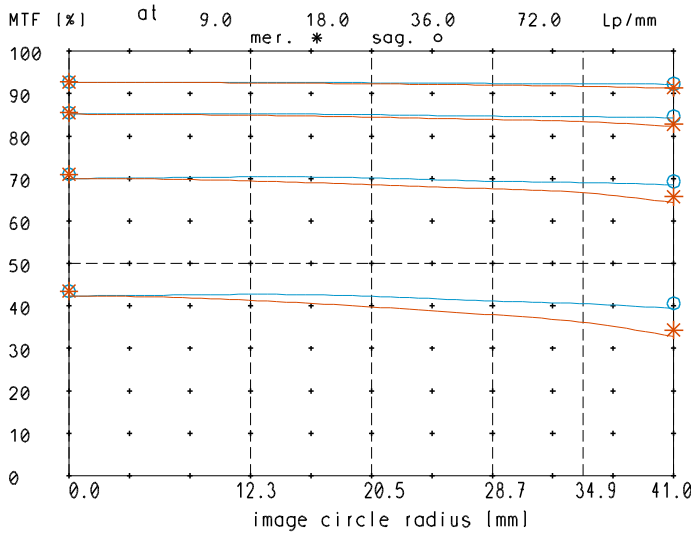

Distortion at ratio 0.06x to 0.52x

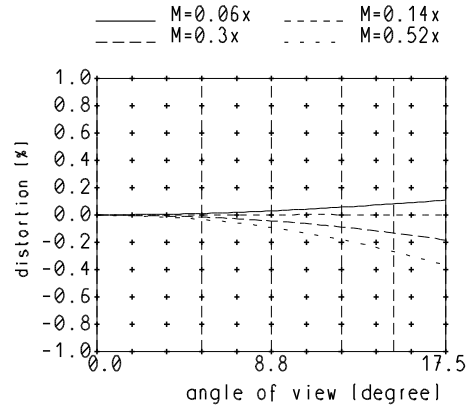

— sagittal, o Diffraction limited value
 — meridional * Diffraction limited value

Longitudinal color aberration at ratio -0.06

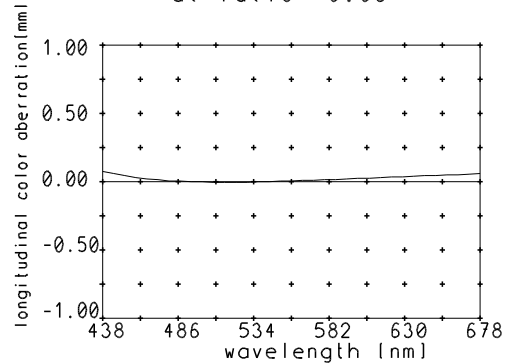

Named frequencies (line pairs/mm) in modular transfer function (MTF) as well as diagrams of relative light fall-off, distortion and longitudinal color aberration refer to film plane.

inspec.x_L_5.6/120_float

MTF at ratio -0.14 f/ 7.8

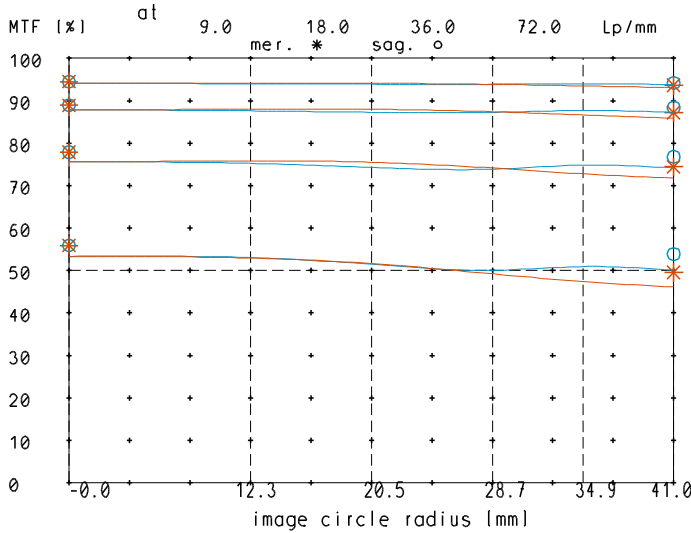

relative light fall-off at ratio -0.14

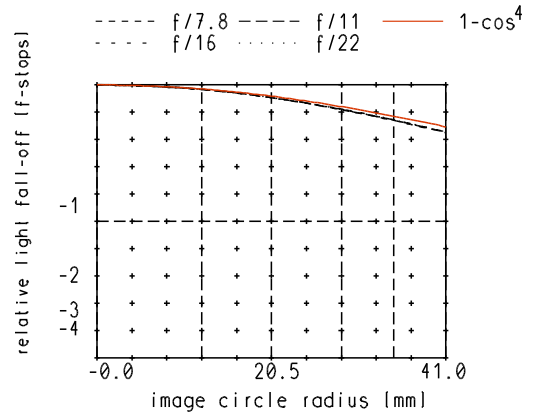

MTF at ratio -0.14 f/ 11

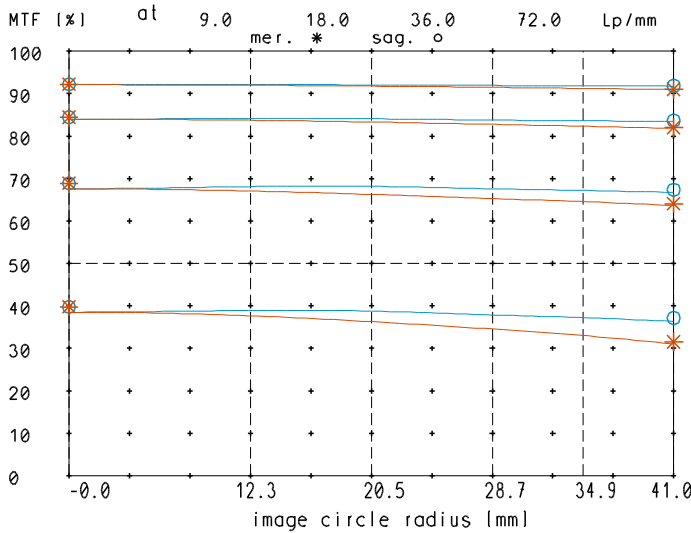

Distortion at ratio 0.06x to 0.52x

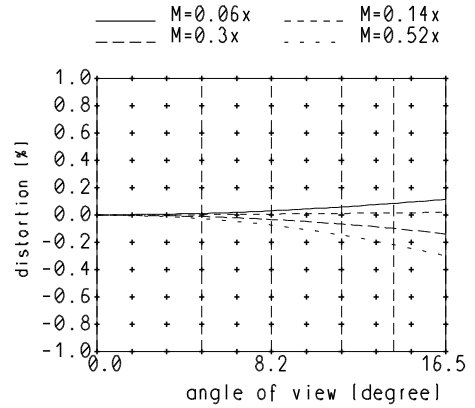

— sagittal, o Diffraction limited value
 — meridional * Diffraction limited value

Longitudinal color aberration at ratio -0.14

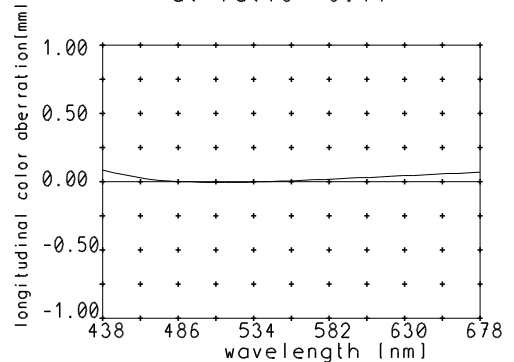

Named frequencies (line pairs/mm) in modular transfer function (MTF) as well as diagrams of relative light fall-off, distortion and longitudinal color aberration refer to film plane.

inspec.x_L_5.6/120_float

MTF at ratio -0.3 f/ 6.9

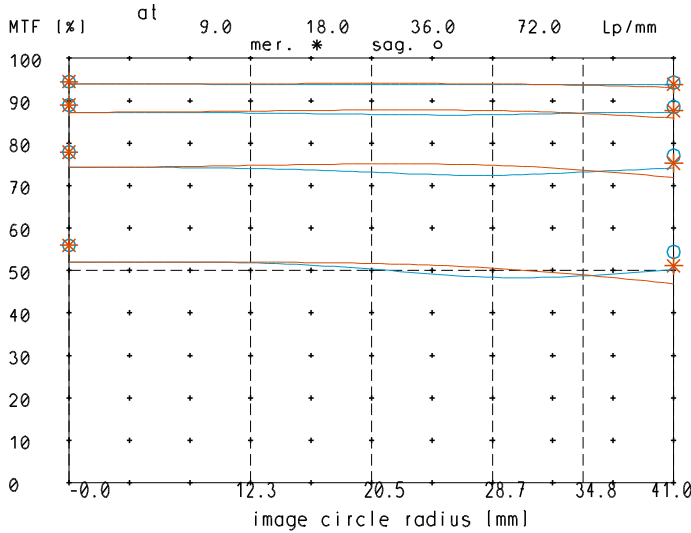

relative light fall-off at ratio -0.3

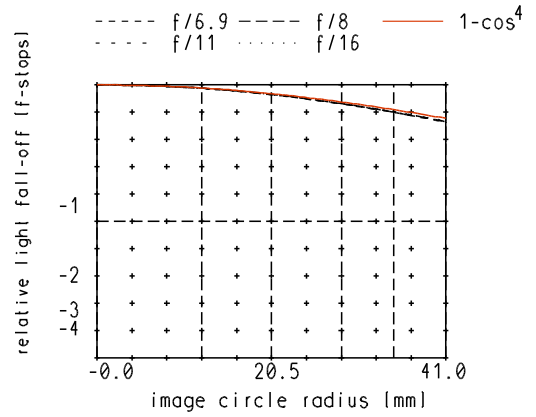

MTF at ratio -0.3 f/ 8

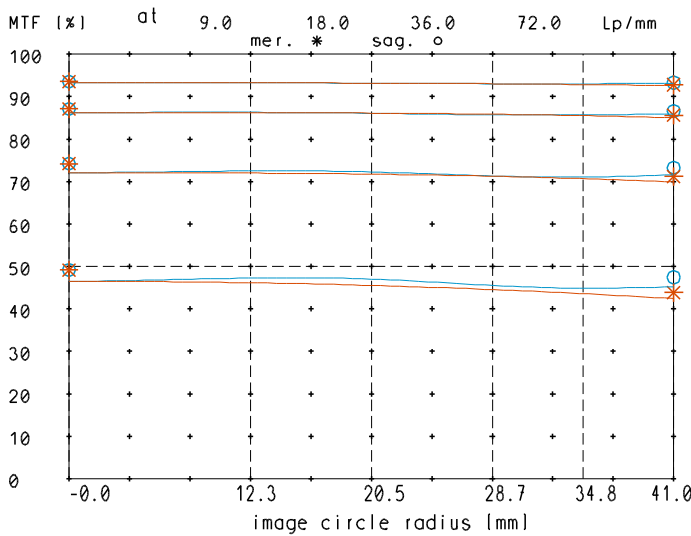

Distortion at ratio 0.06x to 0.52x

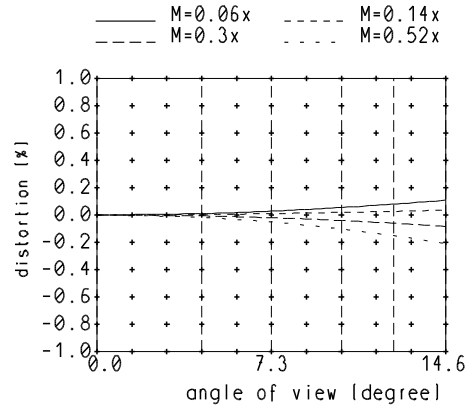

— sagittal, o Diffraction limited value
 — meridional * Diffraction limited value

Longitudinal color aberration at ratio -0.3

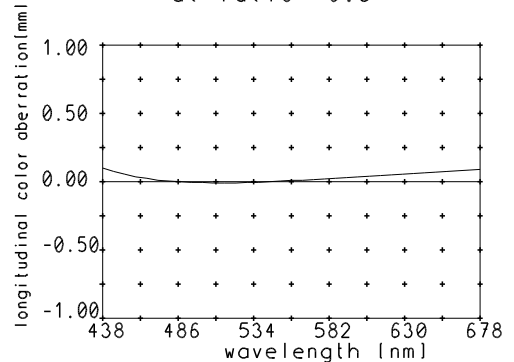

Named frequencies (line pairs/mm) in modular transfer function (MTF) as well as diagrams of relative light fall-off, distortion and longitudinal color aberration refer to film plane.

inspec.x_L_5.6/120_float

MTF at ratio -0.52 f/ 5.6

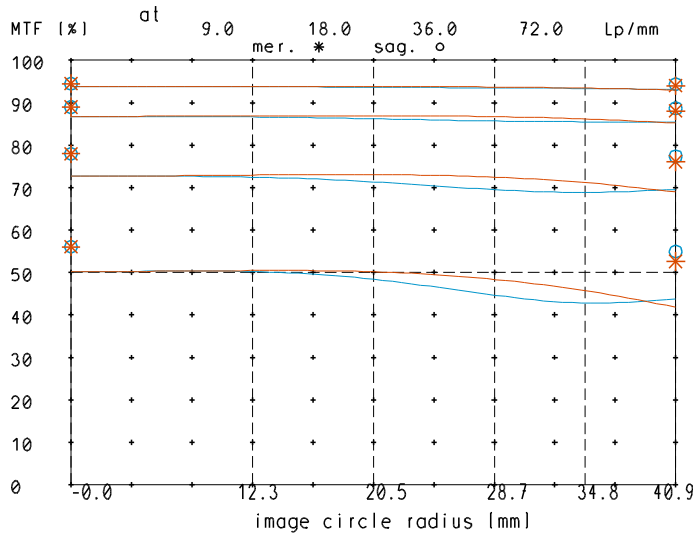

relative light fall-off at ratio -0.52

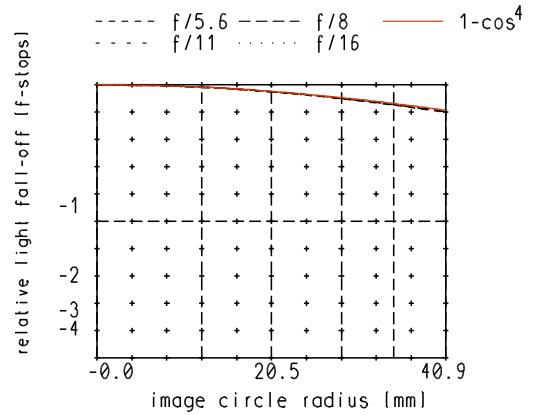

MTF at ratio -0.52 f/ 8

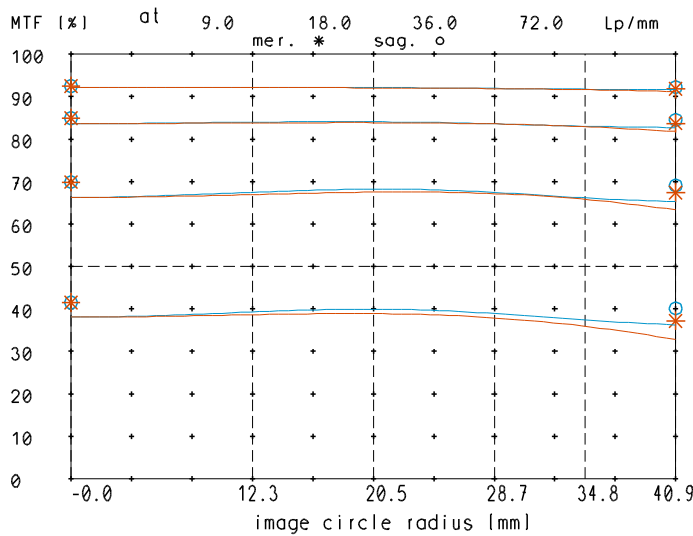

Distortion at ratio 0.06x to 0.52x

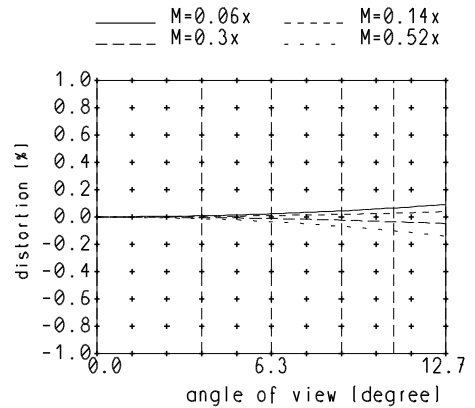

— sagittal, o Diffraction limited value
 — meridional * Diffraction limited value

Longitudinal color aberration at ratio -0.52

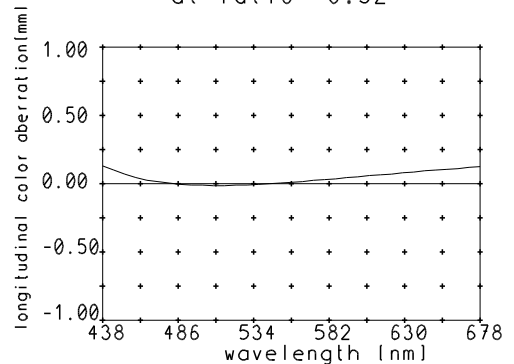

Named frequencies (line pairs/mm) in modular transfer function (MTF) as well as diagrams of relative light fall-off, distortion and longitudinal color aberration refer to film plane.