

## Plug - PP-H 4/13 - 3212087

Please be informed that the data shown in this PDF Document is generated from our Online Catalog. Please find the complete data in the user's documentation. Our General Terms of Use for Downloads are valid (<http://phoenixcontact.com/download>)



Plug, Connection method: Push-in / plug connection, Number of positions: 13, Cross section: 0.2 mm<sup>2</sup> - 6 mm<sup>2</sup>, AWG: 24 - 10, Width: 80.6 mm, Height: 42.3 mm, Color: gray

The figure shows a version of the article

### Why buy this product

- Large-surface labeling option
- The Push-in technology COMBI plugs for self-assembly provide solutions that users can implement themselves
- Tested for railway applications

### Key Commercial Data

Packing unit	1 STK
Minimum order quantity	10 STK
Custom tariff number	85366990
Country of origin	Poland

### Technical data

#### Environmental Product Compliance

China RoHS	No hazardous substances above threshold values
------------	--

#### General

Number of positions	13
Number of levels	1
Number of connections	13
Potentials	13
Nominal cross section	4 mm <sup>2</sup>
Color	gray
Insulating material	PA

# Plug - PP-H 4/13 - 3212087

## Technical data

### General

Flammability rating according to UL 94	V0
Area of application	Railway industry
	Machine building
	Plant engineering
Rated surge voltage	8 kV
Degree of pollution	3
Overvoltage category	III
Insulating material group	I
Maximum load current	32 A (with 6 mm <sup>2</sup> conductor cross section)
Nominal current I <sub>N</sub>	32 A
Nominal voltage U <sub>N</sub>	800 V
Open side panel	No
Relative insulation material temperature index (Elec., UL 746 B)	130 °C
Temperature index of insulation material (DIN EN 60216-1 (VDE 0304-21))	130 °C
Static insulating material application in cold	-60 °C
Behavior in fire for rail vehicles (DIN 5510-2)	Test passed
Flame test method (DIN EN 60695-11-10)	V0
Oxygen index (DIN EN ISO 4589-2)	>32 %
NF F16-101, NF F10-102 Class I	2
NF F16-101, NF F10-102 Class F	2
Surface flammability NFPA 130 (ASTM E 162)	passed
Specific optical density of smoke NFPA 130 (ASTM E 662)	passed
Smoke gas toxicity NFPA 130 (SMP 800C)	passed
Calorimetric heat release NFPA 130 (ASTM E 1354)	28 MJ/kg
Fire protection for rail vehicles (DIN EN 45545-2) R22	HL 1 - HL 3
Fire protection for rail vehicles (DIN EN 45545-2) R23	HL 1 - HL 3
Fire protection for rail vehicles (DIN EN 45545-2) R24	HL 1 - HL 3
Fire protection for rail vehicles (DIN EN 45545-2) R26	HL 1 - HL 3

### Dimensions

Width	80.6 mm
Length	21 mm
Height	42.3 mm
	24 mm
Pitch	6.2 mm

### Connection data

Connection method	Push-in / plug connection
-------------------	---------------------------

# Plug - PP-H 4/13 - 3212087

## Technical data

### Connection data

Connection in acc. with standard	IEC 61984
Conductor cross section solid min.	0.2 mm <sup>2</sup>
Conductor cross section solid max.	6 mm <sup>2</sup>
Conductor cross section AWG min.	24
Conductor cross section AWG max.	10
Conductor cross section flexible min.	0.2 mm <sup>2</sup>
Conductor cross section flexible max.	4 mm <sup>2</sup>
Min. AWG conductor cross section, flexible	24
Max. AWG conductor cross section, flexible	12
Conductor cross section flexible, with ferrule without plastic sleeve min.	0.25 mm <sup>2</sup>
Conductor cross section flexible, with ferrule without plastic sleeve max.	4 mm <sup>2</sup>
Conductor cross section flexible, with ferrule with plastic sleeve min.	0.25 mm <sup>2</sup>
Conductor cross section flexible, with ferrule with plastic sleeve max.	4 mm <sup>2</sup>
2 conductors with same cross section, stranded, TWIN ferrules with plastic sleeve, min.	0.5 mm <sup>2</sup>
2 conductors with same cross section, stranded, TWIN ferrules with plastic sleeve, max.	1 mm <sup>2</sup>
Stripping length	10 mm ... 12 mm
Internal cylindrical gage	A4

### Standards and Regulations

Connection in acc. with standard	CUL
	IEC 61984
Flammability rating according to UL 94	V0

## Drawings

### Circuit diagram



### Diagram

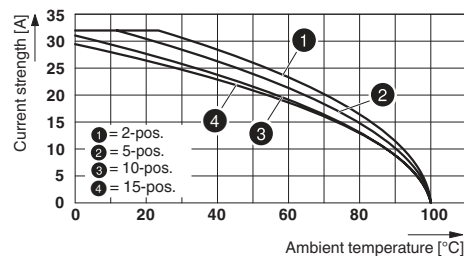

# Plug - PP-H 4/13 - 3212087

Schematic diagram

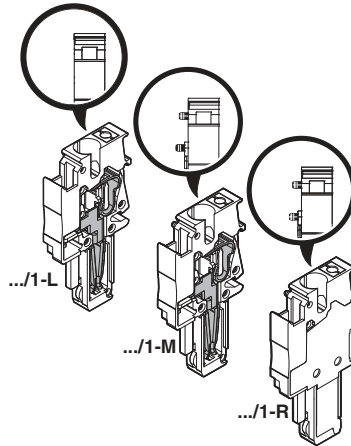

## Classifications

### eCl@ss

eCl@ss 4.0	272607xx
eCl@ss 4.1	27260701
eCl@ss 5.0	27260701
eCl@ss 5.1	27260701
eCl@ss 6.0	27141151
eCl@ss 7.0	27141151
eCl@ss 8.0	27141151
eCl@ss 9.0	27141151

### ETIM

ETIM 4.0	EC002021
ETIM 5.0	EC002021

### UNSPSC

UNSPSC 6.01	30211802
UNSPSC 7.0901	39121402
UNSPSC 11	39121402
UNSPSC 12.01	39121402
UNSPSC 13.2	39121402

## Approvals

### Approvals

# Plug - PP-H 4/13 - 3212087

## Approvals

### Approvals

UL Recognized / cUL Recognized / LR / EAC / BV / DNV GL / cULus Recognized

### Ex Approvals

### Approval details

UL Recognized <http://database.ul.com/cgi-bin/XYV/template/LISEXT/1FRAME/index.htm> FILE E 60425

	B	C
mm <sup>2</sup> /AWG/kcmil	24-10	24-10
Nominal current I <sub>N</sub>	28 A	28 A
Nominal voltage U <sub>N</sub>	600 V	600 V

cUL Recognized <http://database.ul.com/cgi-bin/XYV/template/LISEXT/1FRAME/index.htm> FILE E 60425

	B	C
mm <sup>2</sup> /AWG/kcmil	24-10	24-10
Nominal current I <sub>N</sub>	28 A	28 A
Nominal voltage U <sub>N</sub>	600 V	600 V

LR <http://www.lr.org/en> 14/20057

EAC 7500651.22.01.00246

BV [http://www.veristar.com/wps/portal!ut/p/\\_s.7\\_0\\_A/7\\_0\\_RIM](http://www.veristar.com/wps/portal!ut/p/_s.7_0_A/7_0_RIM) 39979/A0 BV

DNV GL <https://www.dnvgl.com/> TAE000010T

cULus Recognized <http://database.ul.com/cgi-bin/XYV/template/LISEXT/1FRAME/index.htm>

## Plug - PP-H 4/13 - 3212087

### Accessories

#### Accessories

#### Cable housing

##### Cable housing - PH 4/2 - 3000734



Cable housing, Pitch: 6.2 mm, Length: 21 mm, Width: 12.4 mm, Height: 52.3 mm, Number of positions: 2, Color: gray

---

##### Cable housing - PH 4/3 - 3000736



Cable housing, Pitch: 6.2 mm, Length: 21 mm, Width: 18.6 mm, Height: 52.3 mm, Number of positions: 3, Color: gray

---

##### Cable housing - PH 4/4 - 3000737



Cable housing, Pitch: 6.2 mm, Length: 21 mm, Width: 24.8 mm, Height: 52.3 mm, Number of positions: 4, Color: gray

---

##### Cable housing - PH 4/5 - 3000738



Cable housing, Pitch: 6.2 mm, Length: 21 mm, Width: 31 mm, Height: 52.3 mm, Number of positions: 5, Color: gray

---

##### Cable housing - PH 4/6 - 3000739



Cable housing, Pitch: 6.2 mm, Length: 21 mm, Width: 37.2 mm, Height: 52.3 mm, Number of positions: 6, Color: gray

## Plug - PP-H 4/13 - 3212087

### Accessories

---

#### Cable housing - PH 4/7 - 3000740



Cable housing, Pitch: 6.2 mm, Length: 21 mm, Width: 43.4 mm, Height: 52.3 mm, Number of positions: 7, Color: gray

---

#### Cable housing - PH 4/8 - 3000741



Cable housing, Pitch: 6.2 mm, Length: 21 mm, Width: 49.6 mm, Height: 52.3 mm, Number of positions: 8, Color: gray

---

#### Cable housing - PH 4/9 - 3000742



Cable housing, Pitch: 6.2 mm, Length: 21 mm, Width: 55.8 mm, Height: 52.3 mm, Number of positions: 9, Color: gray

---

#### Cable housing - PH 4/10 - 3000743



Cable housing, Pitch: 6.2 mm, Length: 21 mm, Width: 62 mm, Height: 52.3 mm, Number of positions: 10, Color: gray

---

### Insulating sleeve

#### Insulating sleeve - MPS-IH WH - 0201663



Insulating sleeve, Color: white

---

## Plug - PP-H 4/13 - 3212087

### Accessories

Insulating sleeve - MPS-IH RD - 0201676



Insulating sleeve, Color: red

---

Insulating sleeve - MPS-IH BU - 0201689



Insulating sleeve, Color: blue

---

Insulating sleeve - MPS-IH YE - 0201692



Insulating sleeve, Color: yellow

---

Insulating sleeve - MPS-IH GN - 0201702



Insulating sleeve, Color: green

---

Insulating sleeve - MPS-IH GY - 0201728



Insulating sleeve, Color: gray

---



## Plug - PP-H 4/13 - 3212087

### Accessories

Insulating sleeve - MPS-IH BK - 0201731



Insulating sleeve, Color: black

---

Insulating sleeve - ISH 4/0,5 - 3002885



Insulating sleeve, Color: gray

---

Insulating sleeve - ISH 4/1,0 - 3002898



Insulating sleeve, Color: black

---

### Labeled terminal marker

Zack Marker strip, flat - ZBF 6 CUS - 0825027



Zack Marker strip, flat, Strip, can be ordered: Strip, white, labeled according to customer specifications, Mounting type: Snap into flat marker groove, for terminal block width: 6.2 mm, Lettering field: 5.15 x 6.15 mm

---

Marker for terminal blocks - UC-TMF 6 CUS - 0824646



Marker for terminal blocks, can be ordered: by sheet, white, labeled according to customer specifications, Mounting type: Snap into flat marker groove, for terminal block width: 6.2 mm, Lettering field: 5.6 x 5.1 mm

---

## Plug - PP-H 4/13 - 3212087

### Accessories

Marker for terminal blocks - UCT-TMF 6 CUS - 0829665



Marker for terminal blocks, can be ordered: by sheet, white, labeled according to customer specifications, Mounting type: Snap into flat marker groove, for terminal block width: 6.2 mm, Lettering field: 5.4 x 4.7 mm

---

Zack Marker strip, flat - ZBF 6,LGS:FORTL.ZAHLEN - 0808749



Zack Marker strip, flat, Strip, white, labeled, Printed horizontally: Consecutive numbers 1 - 10, 11 - 20, etc. up to 91 - 100, Mounting type: Snap into flat marker groove, for terminal block width: 6.2 mm, Lettering field: 5.15 x 6.15 mm

---

Zack Marker strip, flat - ZBF 6,QR:FORTL.ZAHLEN - 0808765



Zack Marker strip, flat, Strip, white, labeled, Printed vertically: Consecutive numbers 1 - 10, 11 - 20, etc. up to 91 - 100, Mounting type: Snap into flat marker groove, for terminal block width: 6.2 mm, Lettering field: 5.15 x 6.15 mm

---

Zack Marker strip, flat - ZBF 6,LGS:GERADE ZAHLEN - 0810834



Zack Marker strip, flat, Strip, white, labeled, Printed horizontally: Consecutive numbers 2 - 20, 22 - 40, etc. up to 82 - 100, Mounting type: Snap into flat marker groove, for terminal block width: 6.2 mm, Lettering field: 5.15 x 6.15 mm

---

Zack Marker strip, flat - ZBF 6,LGS:UNGERADE ZAHLEN - 0810876



Zack Marker strip, flat, Strip, white, labeled, Printed horizontally: Odd numbers 1 - 19, 21 - 39, etc. up to 81 - 99, Mounting type: Snap into flat marker groove, for terminal block width: 6.2 mm, Lettering field: 5.15 x 6.15 mm

---

### Mounting material

## Plug - PP-H 4/13 - 3212087

### Accessories

Latching - PR/2 - 3040630



Latching, Number of positions: 2, Color: orange

---

Latching - PRT/2 - 3040631



Latching, can only be released using a screwdriver, Number of positions: 2, Color: orange

---

Latching - PRZ - 3040614



Latching, Length: 3 mm, Width: 5.2 mm, Number of positions: 2, Color: orange

---

Latching - PR - 3040559



Latching, Number of positions: 1, Color: orange

---

### Screwdriver tools

Screwdriver - SZF 1-0,6X3,5 - 1204517



Actuation tool, for ST terminal blocks, also suitable for use as a bladed screwdriver, size: 0.6 x 3.5 x 100 mm, 2-component grip, with non-slip grip

---

## Plug - PP-H 4/13 - 3212087

### Accessories

Screwdriver - ST-BW - 1207608



Actuation tool, for all 2.5 mm<sup>2</sup> - 4.0 mm<sup>2</sup> spring-cages

---

### Shield connection

Shield connection clip - PSH 3- 6 - 3040591



Shield connection clip, Color: black

---

Shield connection clip - PSH 5-10 - 3040601



Shield connection clip, Color: black

---

### Terminal marking

Zack Marker strip, flat - ZBF 6:UNBEDRUCKT - 0808710



Zack Marker strip, flat, Strip, white, unlabeled, can be labeled with: Plotter, Mounting type: Snap into flat marker groove, for terminal block width: 6.2 mm, Lettering field: 5.15 x 6.15 mm

---

Marker for terminal blocks - UC-TMF 6 - 0818140



Marker for terminal blocks, Sheet, white, unlabeled, can be labeled with: BLUEMARK CLED, BLUEMARK LED, Plotter, Mounting type: Snap into flat marker groove, for terminal block width: 6.2 mm, Lettering field: 5.6 x 5.1 mm

## Plug - PP-H 4/13 - 3212087

### Accessories

---

#### Marker for terminal blocks - UCT-TMF 6 - 0828746



Marker for terminal blocks, Sheet, white, unlabeled, can be labeled with: THERMOMARK CARD, BLUEMARK CLED, BLUEMARK LED, TOPMARK LASER, THERMOMARK PRIME, Mounting type: Snap into flat marker groove, for terminal block width: 6.2 mm, Lettering field: 5.4 x 4.7 mm

---

#### Test plug terminal block

#### Test plugs - MPS-MT - 0201744



Test plugs, Color: silver