

<p>GlobTek, Inc. www.globtek.com 186 Veterans Drive, Northvale, NJ 07647 Tel. (201) 784-1000 Fax (201) 784-0111</p>	<p>Drawing Title: GTM46402-3509, Medical/ICT/ITE/Household use Power Supply, Efficiency Level: USA DOE Level VI / Eco-design Directive 2009/125/EC, (EU) 2019/1782, Case Color/Style: GlobTek Black, Wall Plug-in, Regulated Switchmode AC-DC Power Supply AC Adaptor, Input Rating: 100-240V~, 50-60 Hz, Interchangeable Blades http://en.globtek.com/interchangeable-blades.php, Output Rating: 35W, 9.0V@3.88A, Output Configuration: 1200 mm, 16/2 Cond, UL 2468, Female Barrel 5.5*2.1*11mm w/ Spring Clip & Locking Notch or Equal, Ferrite: None, GlobTek Black, GT Cord # C17743, Pin Out: Center Positive (+V), symbol compliant with IEC 60417 symbol no. 5926, Blades/Input Cord: (Order Separately), Approvals: cETLus 60950-1; UL 1310; PSE; RCM; cETLus 60601-1 3rd; CB 60335; CB 60950; cETLus 60950; CB 60601-1; Fuse 60335; Fuse 60335; cETLus UL1310; UL 1310; SELV; CB 62368; EAC; LPS 60950; 2MOPP; Korea (15V-24V Only); CCC; PSE; PSE; UKCA; GEMS (24V); UL 1310; Conforms to 62368-1; LPS 62368; ETL 62368; Morocco; Singapore (12V); EAC; India BIS 5.5.95.9,12,13.4,15,18,19,24,48V only; Taiwan BSMI; CE; Ukraine; VCCI; RoHS; Level VI; FCC; CAN ICES-3; IP52; Double Insulation; WEEE; cETLus 60601-1-1;ion; WEEE;</p>	
	<p>Model No. GTM46402-3509</p>	
	<p>Part No./Ordering No. WR9QD3888CCP-N(R6B)</p>	<p>Rev C</p>

In Addition to GlobTek Inc.'s renewed ISO9001:2015 - Quality Management System Certification, GlobTek Inc. is now certified to:

ISO13485:2016 - Medical Devices Quality Management System Certification

ISO14001:2015 - Environmental Management System Certification

ISO Certificates are available online at <https://www.globtek.com/iso-certificates/>

The acceptance of this specification and use of the product described in this document indicates the acceptance and binding of the customer to Globtek TERMS AND CONDITIONS (attached to the end of this document), which supersede all other agreements, terms, and conditions (<https://en.globtek.com/terms-and-conditions/>).

The purchaser of this product (Customer) agrees that it is their sole responsibility to determine suitability/fitness of the product described in this specification for their application and to take precautions for protection against any hazards attendant to the handling and use of the product.

Footnote:

GlobTek Inc. will not be liable for the safety and performance of these power supplies/battery packs if unauthorized access and repair occurs. End user should consult applicable UL, CSA or EN standards for proper installation instruction.

Limitation of Use:

GlobTek products are intended for use with commercial, medical, and/or industrial equipment only. GlobTek product are not authorized for use as mission critical components in life support hazardous environment, nuclear or aircraft applications without prior written approval from the CEO of GlobTek Inc.

Contents of this document are subject to change without prior notice.

Customer Approval of Specification:

Please approve, sign and send back to GlobTek so we can complete order processing.

A delay in receipt of this form will delay delivery schedule.

Company Name: _____	Customer P/N: _____
Quote Number: _____	Date: _____
Authorized Representative Name: _____	Authorized Representative Signature: _____

GlobTek, Inc. www.globtek.com 186 Veterans Drive, Northvale, NJ 07647 Tel. (201) 784-1000 Fax (201) 784-0111	Drawing Title: GTM46402-3509, Medical/ICT/ITE/Household use Power Supply, Efficiency Level: USA DOE Level VI / Eco-design Directive 2009/125/EC, (EU) 2019/1782, Case Color/Style: GlobTek Black, Wall Plug-in, Regulated Switchmode AC-DC Power Supply AC Adaptor, Input Rating: 100-240V~, 50-60 Hz, Interchangeable Blades http://en.globtek.com/interchangeable-blades.php , Output Rating: 35W, 9.0V@3.88A, Output Configuration: 1200 mm, 16/2 Cond, UL 2468, Female Barrel 5.5*2.1*11mm w/ Spring Clip & Locking Notch or Equal, Ferrite: None, GlobTek Black, GT Cord # C17743, Pin Out: Center Positive (+V), symbol compliant with IEC 60417 symbol no. 5926, Blades/Input Cord: (Order Separately), Approvals: cETLus 60950-1; UL 1310; PSE; RCM; cETLus 60601-1 3rd; CB 60335; CB 60950; cETLus 60950; CB 60601-1; Fuse 60335; Fuse 60335; cETLus UL1310; UL 1310; SELV; CB 62368; EAC; LPS 60950; 2MOPP; Korea (15V-24V Only); CCC; PSE; PSE; UKCA; GEMS (24V); UL 1310; Conforms to 62368-1; LPS 62368; ETL 62368; Morocco; Singapore (12V); EAC; India BIS 5,5,9,5,9,12,13,4,15,18,19,24,48V only; Taiwan BSMI; CE; Ukraine; VCCI; RoHS; Level VI; FCC; CAN ICES-3; IP52; Double Insulation; WEEE; cETLus 60601-1-1;ion; WEEE;	
	Model No. GTM46402-3509	
	Part No./Ordering No. WR9QD3888CCP-N(R6B)	Rev C

REVISION HISTORY

REV	DESCRIPTION	SUB	DATE	APPROVED
C	Remove Gift Box dimensions, add egg crate, update master carton dimensions to 440*403*300 mm	QA	06/19/2019	QA
B	Add cETLus-Cert-60601-1 approval	QA	02/13/2019	QA
A	Initial release	QA	06/25/2018	QA

POWER SUPPLY INFORMATION

TYPE	Wall Plug-in
TECHNOLOGY	Regulated Switchmode AC-DC Power Supply AC Adaptor
CASE COLOR	GlobTek Black
NAMEPLATE RATED INPUT	100-240V~, 50-60 Hz, 1.0A
INPUT CONFIG	Interchangeable Blades
WATTS	35.00
VOLTS OUT	9.0
CURRENT OUT (Amps)	3.88
BLADE/CORD INCLUDED	None (Order Separately)
BLADE/CORD INSTALLED	None :(Order Separately)
INGRESS PROTECTION	Indoor Use
GROUNDING CONFIGURATION	(F1) Class II / Double Insulated
EFFICIENCY LEVEL	USA DOE Level VI / Eco-design Directive 2009/125/EC, (EU) 2019/1782
OUTPUT CONFIGURATION	1200 mm, 16/2 Cond, UL 2468, Female Barrel 5.5*2.1*11mm w/ Spring Clip & Locking Notch or Equal, Ferrite: None, GlobTek Black, GT Cord # C17743
OVERMOLDED	Yes
CONNECTOR PIN OUT	Center Positive (+V), symbol compliant with IEC 60417 symbol no. 5926
LABEL SPECS	Standard GT,L-1186
SPECIAL BARCODE LABEL MATERIAL	No
PACK SPEC	Cellular packaging, Generic for Q, User Manual
USER MANUAL	809-PSUQKITUSERMANUAL on A4 paper

PROPRIETARY INFORMATION

PROPRIETARY OF GLOBTEK, INC. ANY REPRODUCTION, DISCLOSURE OR USE OF THIS DRAWING, IN WHOLE OR IN PART, IS HEREBY PROHIBITED EXCEPT AS SPECIFIED IN

WRITING BY GLOBTEK, INC. © GlobTek, Inc. 2018 - 2023

quest / 08/04/2023 5:13:36 PM GMT CLONED FROM WR9QE3000CCPNKITRVB

<p>GlobTek, Inc. www.globtek.com 186 Veterans Drive, Northvale, NJ 07647 Tel. (201) 784-1000 Fax (201) 784-0111</p>	<p>Drawing Title: GTM46402-3509, Medical/ICT/ITE/Household use Power Supply, Efficiency Level: USA DOE Level VI / Eco-design Directive 2009/125/EC, (EU) 2019/1782, Case Color/Style: GlobTek Black, Wall Plug-in, Regulated Switchmode AC-DC Power Supply AC Adaptor, Input Rating: 100-240V~, 50-60 Hz, Interchangeable Blades http://en.globtek.com/interchangeable-blades.php, Output Rating: 35W, 9.0V@3.88A, Output Configuration: 1200 mm, 16/2 Cond, UL 2468, Female Barrel 5.5*2.1*11mm w/ Spring Clip & Locking Notch or Equal, Ferrite: None, GlobTek Black, GT Cord # C17743, Pin Out: Center Positive (+V), symbol compliant with IEC 60417 symbol no. 5926, Blades/Input Cord: (Order Separately), Approvals: cETLus 60950-1; UL 1310; PSE; RCM; cETLus 60601-1 3rd; CB 60335; CB 60950; cETLus 60950; CB 60601-1; Fuse 60335; Fuse 60335; cETLus UL1310; UL 1310; SELV; CB 62368; EAC; LPS 60950; 2MOPP; Korea (15V-24V Only); CCC; PSE; PSE; UKCA; GEMS (24V); UL 1310; Conforms to 62368-1; LPS 62368; ETL 62368; Morocco; Singapore (12V); EAC; India BIS 5.5.95,9,12,13.4,15,18,19,24,48V only; Taiwan BSMI; CE; Ukraine; VCCI; RoHS; Level VI; FCC; CAN ICES-3; IP52; Double Insulation; WEEE; cETLus 60601-1-11;ion; WEEE;</p>
	<p>Model No. GTM46402-3509</p>
	<p>Part No./Ordering No. WR9QD3888CCP-N(R6B) Rev C</p>

Notes/Modifications/Customizations (notes in this section supersede the values shown in the standard spec)
DIMENSIONS ARE IN MM UNLESS SPECIFIED OTHERWISE

GlobTek, Inc. www.globtek.com 186 Veterans Drive, Northvale, NJ 07647 Tel. (201) 784-1000 Fax (201) 784-0111	Drawing Title: GTM46402-3509, Medical/ICT/ITE/Household use Power Supply, Efficiency Level: USA DOE Level VI / Eco-design Directive 2009/125/EC, (EU) 2019/1782, Case Color/Style: GlobTek Black, Wall Plug-in, Regulated Switchmode AC-DC Power Supply AC Adaptor, Input Rating: 100-240V~, 50-60 Hz, Interchangeable Blades http://en.globtek.com/interchangeable-blades.php , Output Rating: 35W, 9.0V@3.88A, Output Configuration: 1200 mm, 16/2 Cond, UL 2468, Female Barrel 5.5*2.1*11mm w/ Spring Clip & Locking Notch or Equal, Ferrite: None, GlobTek Black, GT Cord # C17743, Pin Out: Center Positive (+V), symbol compliant with IEC 60417 symbol no. 5926, Blades/Input Cord: (Order Separately), Approvals: cETLus 60950-1; UL 1310; PSE; RCM; cETLus 60601-1 3rd; CB 60335; CB 60950; cETLus 60950; CB 60601-1; Fuse 60335; Fuse 60335; cETLus UL1310; UL 1310; SELV; CB 62368; EAC; LPS 60950; 2MOPP; Korea (15V-24V Only); CCC; PSE; PSE; UKCA; GEMS (24V); UL 1310; Conforms to 62368-1; LPS 62368; ETL 62368; Morocco; Singapore (12V); EAC; India BIS 5.5.95.9,12,13.4,15,18,19,24,48V only; Taiwan BSMI; CE; Ukraine; VCCI; RoHS; Level VI; FCC; CAN ICES-3; IP52; Double Insulation; WEEE; cETLus 60601-1-1;ion; WEEE;
	Model No. GTM46402-3509
	Part No./Ordering No. WR9QD3888CCP-N(R6B)
	Rev C

ELECTRICAL SPECIFICATIONS

A) ELECTRICAL SPECIFICATIONS:

01. Input Voltage: Specified 90-264 Vac, Nameplate rated: 100-240Vac
 - 90-264 Vac range @ 100% of rated load current
 - 85-264 Vac range @ 85% of rated load current
 - 110-370 VDC range @ 100% of rated load current
02. Input Frequency: Specified 47-63 Hz, Nameplate rated 50-60Hz
03. Output Regulation: +/- 5% measured at the output connector
04. Line Voltage Regulation: +/- 0.5% typical measured at full load
05. Output Ripple (Vp-p): 1% or 100 mV whichever is greater, measured at 20 MHz bandwidth with 0.1 uf ceramic capacitor in parallel with a low impedance 47 uf electrolytic capacitor connected at the end of the output connector
06. Turn-ON/OFF Overshoot: 5% maximum, 1 mS typical recovery time for 40% to 70% step load
07. Turn-ON Delay: 1 second maximum @ full load, nominal line
08. Hold-Up Time: 8 mS typical @ nominal input voltage and full load
09. Inrush Current: 30A/60A maximum cold start @ 115/230Vac input
10. Efficiency: Compliant with Efficiency Level VI and CoC Tier 2 standards
11. No Load Standby Power: <0.075 W @ 230Vac

B) PROTECTION

01. Input Protection: Input line fusing and 300Vac MOV
02. Short Circuit/ Overload: Electronically Protected unit will auto recover upon removal of fault
 - Output Current Limit: 110% to 160% of rated output current
 - (upper end of current limit range is determined by normal output power rating, not derated output power level)
03. Output Over-Voltage: 110% to 130% of nominal output voltage

C) SAFETY

01. Dielectric Withstand Voltage: 4000Vac or 5656Vdc from input to output
02. Earth Leakage Current: N/A for Class II models
03. Touch Current: < 95uA
04. Means of Protection for Medical Standard: 2 x MOPP
05. Compliant Standards: See listings at end of this drawing for specifics

D) EMC

01. Emissions, per EN 55032, EN 61000-6-3, EN 61000-6-4
 - Conducted Emissions: Class B, FCC Part 15, Class B
 - Radiated Emissions: Class B, FCC Part 15, Class B
02. Line Frequency Harmonics EN61000-3-2, Class A
03. Voltage Fluctuations/Flicker EN61000-3-3
04. Immunity, per EN 55024, EN 61000-6-1, EN 61000-6-2
 - Static Discharge Immunity EN61000-4-2, 8kV Contact Discharge, 15kV air discharge
 - Radiated RF Immunity EN61000-4-3, 3V/m 80-2700MHz, 80% 1KHz AM.
 - EFT/Burst Immunity EN61000-4-4, 2kV/100kHz.
 - Line Surge Immunity EN61000-4-5, 1kV differential, 2kV common-mode
 - Conducted RF Immunity EN61000-4-6, 3Vrms, 80% 1KHz AM
 - Power Frequency Magnetic Field Immunity EN61000-4-8, NA

PROPRIETARY INFORMATION

PROPRIETARY OF GLOBTEK, INC. ANY REPRODUCTION, DISCLOSURE OR USE OF THIS DRAWING, IN WHOLE OR IN PART, IS HEREBY PROHIBITED EXCEPT AS SPECIFIED IN WRITING BY GLOBTEK, INC. © GlobTek, Inc. 2018 - 2023

<p>GlobTek, Inc. www.globtek.com 186 Veterans Drive, Northvale, NJ 07647 Tel. (201) 784-1000 Fax (201) 784-0111</p>	<p>Drawing Title: GTM46402-3509, Medical/ICT/ITE/Household use Power Supply, Efficiency Level: USA DOE Level VI / Eco-design Directive 2009/125/EC, (EU) 2019/1782, Case Color/Style: GlobTek Black, Wall Plug-in, Regulated Switchmode AC-DC Power Supply AC Adaptor, Input Rating: 100-240V~, 50-60 Hz, Interchangeable Blades http://en.globtek.com/interchangeable-blades.php, Output Rating: 35W, 9.0V@3.88A, Output Configuration: 1200 mm, 16/2 Cond, UL 2468, Female Barrel 5.5*2.1*11mm w/ Spring Clip & Locking Notch or Equal, Ferrite: None, GlobTek Black, GT Cord # C17743, Pin Out: Center Positive (+V), symbol compliant with IEC 60417 symbol no. 5926, Blades/Input Cord: (Order Separately), Approvals: cETLus 60950-1; UL 1310; PSE; RCM; cETLus 60601-1 3rd; CB 60335; CB 60950; cETLus 60950; CB 60601-1; Fuse 60335; Fuse 60335; cETLus UL1310; UL 1310; SELV; CB 62368; EAC; LPS 60950; 2MOPP; Korea (15V-24V Only); CCC; PSE; PSE; UKCA; GEMS (24V); UL 1310; Conforms to 62368-1; LPS 62368; ETL 62368; Morocco; Singapore (12V); EAC; India BIS 5.5.95.9,12,13.4,15,18,19,24,48V only; Taiwan BSMI; CE; Ukraine; VCCI; RoHS; Level VI; FCC; CAN ICES-3; IP52; Double Insulation; WEEE; cETLus 60601-1-11;ion; WEEE;</p>	
	<p>Model No. GTM46402-3509</p>	
	<p>Part No./Ordering No. WR9QD3888CCP-N(R6B)</p>	<p>Rev C</p>

<p>Voltage Dip Immunity EN61000-4-11, Criteria</p> <p>E) OTHER:</p> <ol style="list-style-type: none"> 01. MTBF: 1,000,000 Hours @ 40°C ambient temperature, Full Load Projected failure rate expected to be < 0.5% after 5 years, < 3 % after 10 years 02. Operating Temperature: -20°C to 40°C ambient temperature at full load, -40°C to 50°C ambient temperature with derating to 80% load 03. Operating Humidity: 0% to 95% relative humidity, non-condensing 04. Storage Temperature: -40°C to 80°C 05. Operating Altitude: 5000 Meters for IEC 62368-1 and IEC 60335-1. 3000M for IEC 60601-1 06. Ingress Protection: IP40 standard, IP52 available as special option 07. ROHS: Compliant with latest regulations, see approvals section below <p>F) ENCLOSURE</p> <ol style="list-style-type: none"> 01. Housing: High impact plastic, 94V0 polycarbonate, non-vented 02. Markings: Label or Laser Printed 03. AC Input mechanical: Replaceable, Class II Wall Plug-in attachments <p>G) SPECIAL OPTIONS</p> <ol style="list-style-type: none"> 02. Custom Cordsets, various cordage types, and connector types* 03. Custom Markings 06. Tightened output voltage tolerance 07. Reduced output ripple level 08. Reduced output power rating marking 09. High Rel PCB laminate with Plated through Holes for IPC610 Class 2 Compliance 10. Special Housing Colors and Cordset Colors <hr/> <p>TO ADDRESS SYSTEM-LEVEL EMI CONCERNS, FERRITE CHOKES/BEADS MAY BE ADDED/REVISED UPON REQUEST. A SAMPLE KIT OF GLOBTEK'S STANDARD FERRITES IS AVAILABLE UNDER GLOBTEK P/N: EMI-MITIGATION-KIT1</p> <p>FOR ADDITIONAL INFORMATION, PLEASE READ OUR WHITE PAPER AT: https://r.globtek.info/3QeaqtD</p> <p>INGRESS PROTECTION: Indoor Use</p>
--

<p>GlobTek, Inc. www.globtek.com 186 Veterans Drive, Northvale, NJ 07647 Tel. (201) 784-1000 Fax (201) 784-0111</p>	<p>Drawing Title: GTM46402-3509, Medical/ICT/ITE/Household use Power Supply, Efficiency Level: USA DOE Level VI / Eco-design Directive 2009/125/EC, (EU) 2019/1782, Case Color/Style: GlobTek Black, Wall Plug-in, Regulated Switchmode AC-DC Power Supply AC Adaptor, Input Rating: 100-240V~, 50-60 Hz, Interchangeable Blades http://en.globtek.com/interchangeable-blades.php, Output Rating: 35W, 9.0V@3.88A, Output Configuration: 1200 mm, 16/2 Cond, UL 2468, Female Barrel 5.5*2.1*11mm w/ Spring Clip & Locking Notch or Equal, Ferrite: None, GlobTek Black, GT Cord # C17743, Pin Out: Center Positive (+V), symbol compliant with IEC 60417 symbol no. 5926, Blades/Input Cord: (Order Separately), Approvals: cETLus 60950-1; UL 1310; PSE; RCM; cETLus 60601-1 3rd; CB 60335; CB 60950; cETLus 60950; CB 60601-1; Fuse 60335; Fuse 60335; cETLus UL1310; UL 1310; SELV; CB 62368; EAC; LPS 60950; 2MOPP; Korea (15V-24V Only); CCC; PSE; PSE; UKCA; GEMS (24V); UL 1310; Conforms to 62368-1; LPS 62368; ETL 62368; Morocco; Singapore (12V); EAC; India BIS 5.5.95.9,12,13.4,15,18,19,24,48V only; Taiwan BSMI; CE; Ukraine; VCCI; RoHS; Level VI; FCC; CAN ICES-3; IP52; Double Insulation; WEEE; cETLus 60601-1-1;ion; WEEE;</p>	
	<p>Model No. GTM46402-3509</p>	
	<p>Part No./Ordering No. WR9QD3888CCP-N(R6B)</p>	<p>Rev C</p>

3D File Download https://www.globtek.com/file/dl/gtm46402-40vv-x_x-q_asm.stp

Mechanical drawing

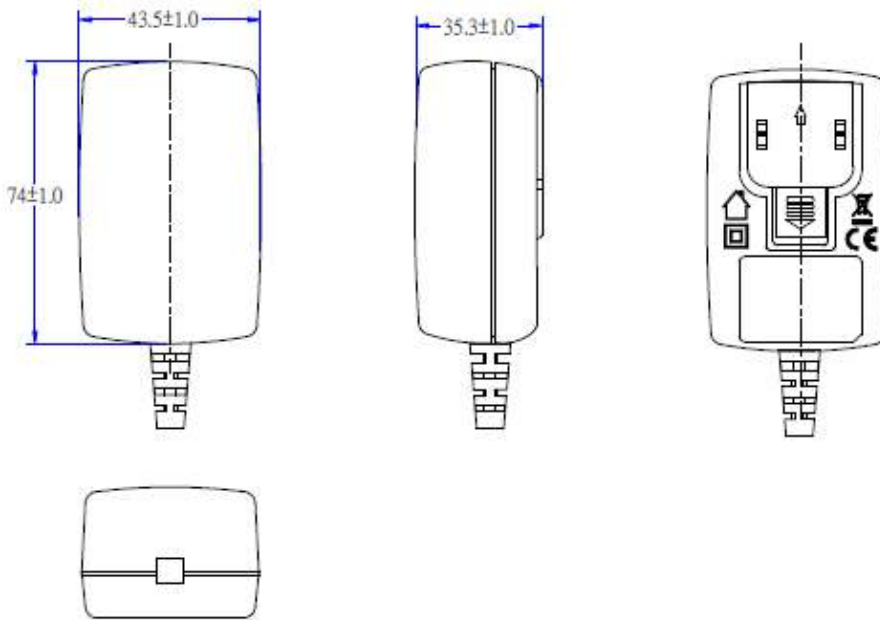

GlobTek, Inc.
 www.globtek.com
 186 Veterans Drive,
 Northvale, NJ 07647
 Tel. (201) 784-1000
 Fax (201) 784-0111

Drawing Title: GTM46402-3509, Medical/ICT/ITE/Household use Power Supply, Efficiency Level: USA DOE Level VI / Eco-design Directive 2009/125/EC, (EU) 2019/1782, Case Color/Style: GlobTek Black, Wall Plug-in, Regulated Switchmode AC-DC Power Supply AC Adaptor, Input Rating: 100-240V~, 50-60 Hz, Interchangeable Blades <http://en.globtek.com/interchangeable-blades.php>, Output Rating: 35W, 9.0V@3.88A, Output Configuration: 1200 mm, 16/2 Cond, UL 2468, Female Barrel 5.5*2.1*11mm w/ Spring Clip & Locking Notch or Equal, Ferrite: None, GlobTek Black, GT Cord # C17743, Pin Out: Center Positive (+V), symbol compliant with IEC 60417 symbol no. 5926, Blades/Input Cord: (Order Separately), Approvals: cETLus 60950-1; UL 1310; PSE; RCM; cETLus 60601-1 3rd; CB 60335; CB 60950; cETLus 60950; CB 60601-1; Fuse 60335; Fuse 60335; cETLus UL1310; UL 1310; SELV; CB 62368; EAC; LPS 60950; 2MOPP; Korea (15V-24V Only); CCC; PSE; PSE; UKCA; GEMS (24V); UL 1310; Conforms to 62368-1; LPS 62368; ETL 62368; Morocco; Singapore (12V); EAC; India BIS 5.5.95,9,12,13.4,15,18,19,24,48V only; Taiwan BSMI; CE; Ukraine; VCCI; RoHS; Level VI; FCC; CAN ICES-3; IP52; Double Insulation; WEEE; cETLus 60601-1-11;ion; WEEE;

Model No. GTM46402-3509

Part No./Ordering No. WR9QD3888CCP-N(R6B)

Rev C

DERATING CURVE

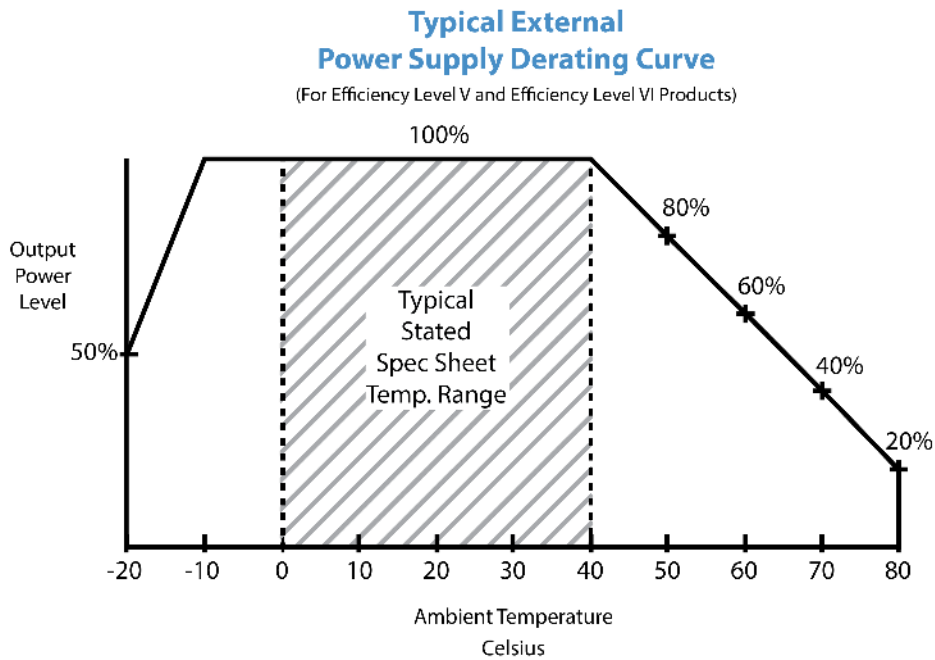

<p>GlobTek, Inc. www.globtek.com 186 Veterans Drive, Northvale, NJ 07647 Tel. (201) 784-1000 Fax (201) 784-0111</p>	<p>Drawing Title: GTM46402-3509, Medical/ICT/ITE/Household use Power Supply, Efficiency Level: USA DOE Level VI / Eco-design Directive 2009/125/EC, (EU) 2019/1782, Case Color/Style: GlobTek Black, Wall Plug-in, Regulated Switchmode AC-DC Power Supply AC Adaptor, Input Rating: 100-240V~, 50-60 Hz, Interchangeable Blades http://en.globtek.com/interchangeable-blades.php, Output Rating: 35W, 9.0V@3.88A, Output Configuration: 1200 mm, 16/2 Cond, UL 2468, Female Barrel 5.5*2.1*11mm w/ Spring Clip & Locking Notch or Equal, Ferrite: None, GlobTek Black, GT Cord # C17743, Pin Out: Center Positive (+V), symbol compliant with IEC 60417 symbol no. 5926, Blades/Input Cord: (Order Separately), Approvals: cETLus 60950-1; UL 1310; PSE; RCM; cETLus 60601-1 3rd; CB 60335; CB 60950; cETLus 60950; CB 60601-1; Fuse 60335; Fuse 60335; cETLus UL1310; UL 1310; SELV; CB 62368; EAC; LPS 60950; 2MOPP; Korea (15V-24V Only); CCC; PSE; PSE; UKCA; GEMS (24V); UL 1310; Conforms to 62368-1; LPS 62368; ETL 62368; Morocco; Singapore (12V); EAC; India BIS 5.5.95.9,12,13.4,15,18,19,24,48V only; Taiwan BSMI; CE; Ukraine; VCCI; RoHS; Level VI; FCC; CAN ICES-3; IP52; Double Insulation; WEEE; cETLus 60601-1-11;ion; WEEE;</p>	
	<p>Model No. GTM46402-3509</p>	
	<p>Part No./Ordering No. WR9QD3888CCP-N(R6B)</p>	<p>Rev C</p>

INPUT CONFIGURATION

(F1) Class II / Double Insulated



[Alternate grounding configurations](#) available upon request.

Blades/Cord Included:None:(Order Separately)

Blades/Cord Installed:None:(Order Separately)

Blade Options for Q Series Wall Plug-in Power Supplies

Data Sheet: <http://en.globtek.com/interchangeable-blades.php>

Insertion Instructions: <http://www.globtek.com/pdf/Instructions-Interchangeable-Blades.pdf>

Video: [Q-Blade Style Instruction Video](#)

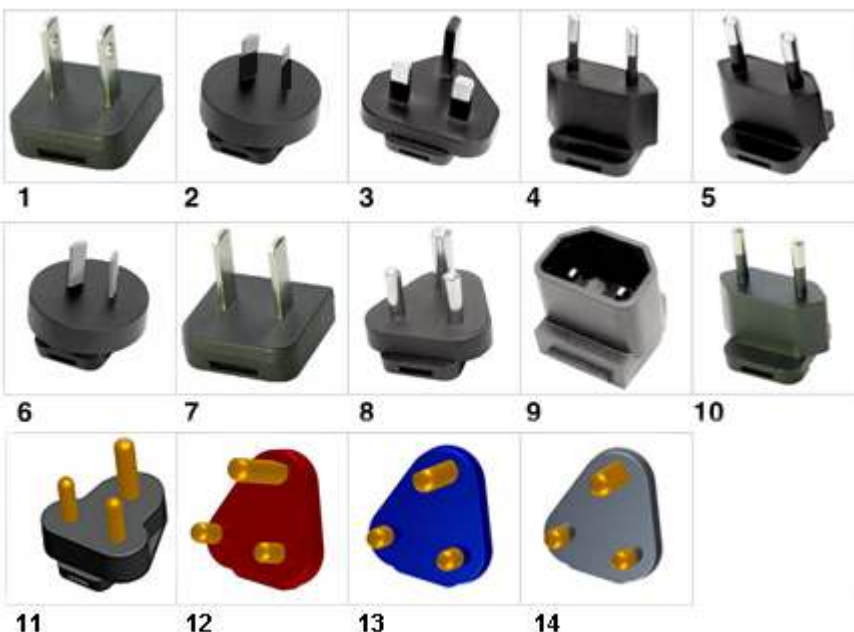

PROPRIETARY INFORMATION

PROPRIETARY OF GLOBTEK, INC. ANY REPRODUCTION, DISCLOSURE OR USE OF THIS DRAWING, IN WHOLE OR IN PART, IS HEREBY PROHIBITED EXCEPT AS SPECIFIED IN

WRITING BY GLOBTEK, INC. © GlobTek, Inc. 2018 - 2023

quest / 08/04/2023 5:13:36 PM GMT CLONED FROM WR9QE3000CCPNKITRVB

GlobTek, Inc. www.globtek.com 186 Veterans Drive, Northvale, NJ 07647 Tel. (201) 784-1000 Fax (201) 784-0111	Drawing Title: GTM46402-3509, Medical/ICT/ITE/Household use Power Supply, Efficiency Level: USA DOE Level VI / Eco-design Directive 2009/125/EC, (EU) 2019/1782, Case Color/Style: GlobTek Black, Wall Plug-in, Regulated Switchmode AC-DC Power Supply AC Adaptor, Input Rating: 100-240V~, 50-60 Hz, Interchangeable Blades http://en.globtek.com/interchangeable-blades.php , Output Rating: 35W, 9.0V@3.88A, Output Configuration: 1200 mm, 16/2 Cond, UL 2468, Female Barrel 5.5*2.1*11mm w/ Spring Clip & Locking Notch or Equal, Ferrite: None, GlobTek Black, GT Cord # C17743, Pin Out: Center Positive (+V), symbol compliant with IEC 60417 symbol no. 5926, Blades/Input Cord: (Order Separately), Approvals: cETLus 60950-1; UL 1310; PSE; RCM; cETLus 60601-1 3rd; CB 60335; CB 60950; cETLus 60950; CB 60601-1; Fuse 60335; Fuse 60335; cETLus UL1310; UL 1310; SELV; CB 62368; EAC; LPS 60950; 2MOPP; Korea (15V-24V Only); CCC; PSE; PSE; UKCA; GEMS (24V); UL 1310; Conforms to 62368-1; LPS 62368; ETL 62368; Morocco; Singapore (12V); EAC; India BIS 5.5.95.9,12,13.4,15,18,19,24,48V only; Taiwan BSMI; CE; Ukraine; VCCI; RoHS; Level VI; FCC; CAN ICES-3; IP52; Double Insulation; WEEE; cETLus 60601-1-1;ion; WEEE;	
	Model No. GTM46402-3509	
	Part No./Ordering No. WR9QD3888CCP-N(R6B)	Rev C

INPUT CONNECTOR: Q-Socket (below are available blades configurations which are "not included" (unless stated above); can be purchased separately, package with power supply or as a separate "Q-KIT" if specified

01. United States / Canada / Japan NEMA 1-15P/ IEC PLUG Type A [WORKS IN PLUG B] configuration: NA 2 blades, Class II; US/CA/JP P/N: Q-NA(R)
02. Australian AS 3112 configuration: SAA 2 blade/ IEC TYPE I, Class II; AU P/N: Q-SAA(R)
03. UK BS 1363 configuration: UK 3 blade with dummy Ground/ IEC TYPE G, Class II; GB P/N: Q-UK(R)
04. European CEE 7/16 configuration: Europlug 2 pins/ IEC TYPE C [WORKS IN TYPE E&F], Class II; EU P/N: Q-EU(R)
05. Korean KS C8305 configuration: 2 pins/SIMILAR TO IEC TYPE C, Class II; KR P/N: Q-KR(R)
06. Argentina IRAM 2073 configuration: 2 blades/SIMILAR TO IEC TYPE I; AR P/N: Class II Q-AR(R)
07. China GB 2099 configuration: 2 blades/SIMILAR TO TYPE A, Class II; CN P/N:Q-CN(R)
08. India IS 1293 6A/BS546 configuration: 5A, 3 pins with Dummy Ground, Class II/IEC TYPE D; IN P/N: Q-IN(R)
09. IEC60320/C18 Inlet, Class II; P/N: Q-C18(R)
10. Brazilian NBR6147 configuration: 2 pins, Class II;SIMILAR TO IEC TYPE C BR P/N: Q-BR(R)
11. South Africa SABS164-1 and India IS 1293, IS694, 16A type plug, 3 round prongs, Class II + dummy ground, IEC TYPE M P/N: Q-SANS164-1-16A(R)
12. South Africa SABS164-4, 3 round prongs with a notched prong @ 0°, Class II + dummy ground, IEC TYPE M Red, P/N: Q-SANS164-4C-16A(R)
13. South Africa SABS164-4, 3 round prongs with a notched prong @ -53°, Class II + dummy ground, Blue, IEC TYPE M, P/N: Q-SANS164-4L-16A(R)
14. South Africa SABS164-4, 3 round prongs with a notched prong @ +53°, Class II + dummy ground, Black,IEC TYPE M P/N: Q-SANS164-4R-16A(R)

Kits

01. Q-KIT: 1,2,3,4 above
02. Q-KIT-INTL: 2,3,4 above
03. Q-KIT-6: 1,2,3,4,5,6 above
04. Q-KIT-7: 1,2,3,4,5,6,7 above
05. Q-KIT-8: 1,2,3,4,5,6,7,8 above

GlobTek, Inc. www.globtek.com 186 Veterans Drive, Northvale, NJ 07647 Tel. (201) 784-1000 Fax (201) 784-0111	Drawing Title: GTM46402-3509, Medical/ICT/ITE/Household use Power Supply, Efficiency Level: USA DOE Level VI / Eco-design Directive 2009/125/EC, (EU) 2019/1782, Case Color/Style: GlobTek Black, Wall Plug-in, Regulated Switchmode AC-DC Power Supply AC Adaptor, Input Rating: 100-240V~, 50-60 Hz, Interchangeable Blades http://en.globtek.com/interchangeable-blades.php , Output Rating: 35W, 9.0V@3.88A, Output Configuration: 1200 mm, 16/2 Cond, UL 2468, Female Barrel 5.5*2.1*11mm w/ Spring Clip & Locking Notch or Equal, Ferrite: None, GlobTek Black, GT Cord # C17743, Pin Out: Center Positive (+V), symbol compliant with IEC 60417 symbol no. 5926, Blades/Input Cord: (Order Separately), Approvals: cETLus 60950-1; UL 1310; PSE; RCM; cETLus 60601-1 3rd; CB 60335; CB 60950; cETLus 60950; CB 60601-1; Fuse 60335; Fuse 60335; cETLus UL1310; UL 1310; SELV; CB 62368; EAC; LPS 60950; 2MOPP; Korea (15V-24V Only); CCC; PSE; PSE; UKCA; GEMS (24V); UL 1310; Conforms to 62368-1; LPS 62368; ETL 62368; Morocco; Singapore (12V); EAC; India BIS 5.5.95.9,12,13.4,15,18,19,24,48V only; Taiwan BSMI; CE; Ukraine; VCCI; RoHS; Level VI; FCC; CAN ICES-3; IP52; Double Insulation; WEEE; cETLus 60601-1-11;ion; WEEE;	
	Model No. GTM46402-3509	
	Part No./Ordering No. WR9QD3888CCP-N(R6B)	Rev C

OUTPUT CORD AND CONNECTOR: CL1/C17743

ACTUAL CONNECTORS, OVERMOLDS, FERRITES MAY VARY SLIGHTLY FROM THE PICTURE BELOW

CABLE TYPE	UL 2468
CABLE LENGTH (mm)	1200
CABLE TOLERANCE (mm)	+100-0
WIRE GAUGE (AWG)	16
CONDUCTORS	2
HANK DIMENSION (mm)	90 ± 10
CABLE / CONNECTOR OVERMOLD COLOR	GlobTek Black
FERRITE TYPE AND DIMENSION	None
FERRITE NUMBER OF TURNS (Definition)	N/A
FERRITE DIMENSION FROM STRAIN RELIEF	N/A
FERRITE DIMENSION FROM PLUG	N/A
PLUG TYPE	Female Barrel 5.5*2.1*11mm w/ Spring Clip & Locking Notch or Equal
OVERMOLDED	Yes
OVER MOLD ORIENTATION	Straight
CONNECTOR PIN OUT	Center Positive (+V), symbol compliant with IEC 60417 symbol no. 5926

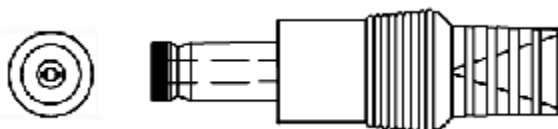

ADDITIONAL OUTPUT PLUG OPTIONS ARE AVAILABLE AT <https://www.globtek.com/connectors/>
STANDARD PLUGS AND CONNECTORS CAN BE SEEN ONLINE AT <https://www.globtek.com/connectors/>
CALCULATE VOLTAGE REGULATION/DROP WITH OUR ONLINE CALCULATOR: <https://en.globtek.com/output-cable-regulation-calculator/>

<p>GlobTek, Inc. www.globtek.com 186 Veterans Drive, Northvale, NJ 07647 Tel. (201) 784-1000 Fax (201) 784-0111</p>	<p>Drawing Title: GTM46402-3509, Medical/ICT/ITE/Household use Power Supply, Efficiency Level: USA DOE Level VI / Eco-design Directive 2009/125/EC, (EU) 2019/1782, Case Color/Style: GlobTek Black, Wall Plug-in, Regulated Switchmode AC-DC Power Supply AC Adaptor, Input Rating: 100-240V~, 50-60 Hz, Interchangeable Blades http://en.globtek.com/interchangeable-blades.php, Output Rating: 35W, 9.0V@3.88A, Output Configuration: 1200 mm, 16/2 Cond, UL 2468, Female Barrel 5.5*2.1*11mm w/ Spring Clip & Locking Notch or Equal, Ferrite: None, GlobTek Black, GT Cord # C17743, Pin Out: Center Positive (+V), symbol compliant with IEC 60417 symbol no. 5926, Blades/Input Cord: (Order Separately), Approvals: cETLus 60950-1; UL 1310; PSE; RCM; cETLus 60601-1 3rd; CB 60335; CB 60950; cETLus 60950; CB 60601-1; Fuse 60335; Fuse 60335; cETLus UL1310; UL 1310; SELV; CB 62368; EAC; LPS 60950; 2MOPP; Korea (15V-24V Only); CCC; PSE; PSE; UKCA; GEMS (24V); UL 1310; Conforms to 62368-1; LPS 62368; ETL 62368; Morocco; Singapore (12V); EAC; India BIS 5.5.95,9,12,13.4,15,18,19,24,48V only; Taiwan BSMI; CE; Ukraine; VCCI; RoHS; Level VI; FCC; CAN ICES-3; IP52; Double Insulation; WEEE; cETLus 60601-1-11;ion; WEEE;</p>
	<p>Model No. GTM46402-3509</p>
	<p>Part No./Ordering No. WR9QD3888CCP-N(R6B) Rev C</p>

OUTPUT CONNECTOR HOOK UP

TO ADDRESS SYSTEM-LEVEL EMI CONCERNS, FERRITE CHOKES/BEADS MAY BE ADDED/REVISED UPON REQUEST. A SAMPLE KIT OF GLOBTEK'S STANDARD FERRITES IS AVAILABLE UNDER GLOBTEK P/N: EMI-MITIGATION-KIT1

FOR ADDITIONAL INFORMATION, PLEASE READ OUR WHITE PAPER AT:

<https://en.globtek.com/technical-articles/ferrite-kit-radiated-emi-suppression-kit-for-globtek-power-supplies-cable-assemblies>

GlobTek, Inc. www.globtek.com 186 Veterans Drive, Northvale, NJ 07647 Tel. (201) 784-1000 Fax (201) 784-0111	Drawing Title: GTM46402-3509, Medical/ICT/ITE/Household use Power Supply, Efficiency Level: USA DOE Level VI / Eco-design Directive 2009/125/EC, (EU) 2019/1782, Case Color/Style: GlobTek Black, Wall Plug-in, Regulated Switchmode AC-DC Power Supply AC Adaptor, Input Rating: 100-240V~, 50-60 Hz, Interchangeable Blades http://en.globtek.com/interchangeable-blades.php, Output Rating: 35W, 9.0V@3.88A, Output Configuration: 1200 mm, 16/2 Cond, UL 2468, Female Barrel 5.5*2.1*11mm w/ Spring Clip & Locking Notch or Equal, Ferrite: None, GlobTek Black, GT Cord # C17743, Pin Out: Center Positive (+V), symbol compliant with IEC 60417 symbol no. 5926, Blades/Input Cord: (Order Separately), Approvals: cETLus 60950-1; UL 1310; PSE; RCM; cETLus 60601-1 3rd; CB 60335; CB 60950; cETLus 60950; CB 60601-1; Fuse 60335; Fuse 60335; cETLus UL1310; UL 1310; SELV; CB 62368; EAC; LPS 60950; 2MOPP; Korea (15V-24V Only); CCC; PSE; PSE; UKCA; GEMS (24V); UL 1310; Conforms to 62368-1; LPS 62368; ETL 62368; Morocco; Singapore (12V); EAC; India BIS 5.5.95.9,12,13.4.15,18,19,24,48V only; Taiwan BSMI; CE; Ukraine; VCCI; RoHS; Level VI; FCC; CAN ICES-3; IP52; Double Insulation; WEEE; cETLus 60601-1-11;ion; WEEE;
	Model No. GTM46402-3509
	Part No./Ordering No. WR9QD3888CCP-N(R6B) Rev C

LABEL:L-1186

LABEL P/N	Standard GT
MATERIAL	Flat Thermal Transfer, Imprintable, Polyester Label and/or Pad Printed and/or Molded, and/or Laser Engraved in the case
BACKGROUND COLOR	Black if housing is Black, White or Silver if housing is White or Gray.
TEXT COLOR	White or Silver if label is Black Background for Black housing. Black if label is White or Silver background and Housing is White or Gray.
LABEL WIDTH (mm)	30
LABEL HEIGHT (mm)	21
SPECIAL BARCODE LABEL MATERIAL	No

Below is the minimum information which will appear on the label. NOTE: in the logo area additional/actual positioning of symbols and text is subjected to change as per agency updates/requirements or additional model approvals become available.
Regulatory certifications/label markings may be in logo area on the label or molded into the case housing outside the label area.
Information will be shown via label and/or pad printed and/or molded and/or laser engraved in the case. * Date code markings at GlobTek option

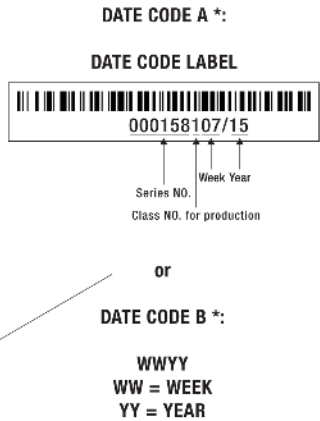

A=Medical/ICT/ITE/Household use Power Supply
B=P/N: (料号) WR9QD3888CCP-N(R6B)
C=Model (型号) GTM46402-3509
D=Input (输入)100-240V~, 50-60 Hz, 1.0A
E=Output (输出)9.0 V 3.88 A, 35.00W

GlobTek, Inc. www.globtek.com 186 Veterans Drive, Northvale, NJ 07647 Tel. (201) 784-1000 Fax (201) 784-0111	Drawing Title: GTM46402-3509, Medical/ICT/ITE/Household use Power Supply, Efficiency Level: USA DOE Level VI / Eco-design Directive 2009/125/EC, (EU) 2019/1782, Case Color/Style: GlobTek Black, Wall Plug-in, Regulated Switchmode AC-DC Power Supply AC Adaptor, Input Rating: 100-240V~, 50-60 Hz, Interchangeable Blades http://en.globtek.com/interchangeable-blades.php , Output Rating: 35W, 9.0V@3.88A, Output Configuration: 1200 mm, 16/2 Cond, UL 2468, Female Barrel 5.5*2.1*11mm w/ Spring Clip & Locking Notch or Equal, Ferrite: None, GlobTek Black, GT Cord # C17743, Pin Out: Center Positive (+V), symbol compliant with IEC 60417 symbol no. 5926, Blades/Input Cord: (Order Separately), Approvals: cETLus 60950-1; UL 1310; PSE; RCM; cETLus 60601-1 3rd; CB 60335; CB 60950; cETLus 60950; CB 60601-1; Fuse 60335; Fuse 60335; cETLus UL1310; UL 1310; SELV; CB 62368; EAC; LPS 60950; 2MOPP; Korea (15V-24V Only); CCC; PSE; PSE; UKCA; GEMS (24V); UL 1310; Conforms to 62368-1; LPS 62368; ETL 62368; Morocco; Singapore (12V); EAC; India BIS 5.5.95.9,12,13.4,15,18,19,24,48V only; Taiwan BSMI; CE; Ukraine; VCCI; RoHS; Level VI; FCC; CAN ICES-3; IP52; Double Insulation; WEEE; cETLus 60601-1-1;ion; WEEE;	
	Model No. GTM46402-3509	
	Part No./Ordering No. WR9QD3888CCP-N(R6B)	Rev C

AGENCY ONLINE DOCUMENTS	http://www.globtek.info/certs/GTM46402/
CE EC-Declaration for Medical	http://globtek.force.com/models/ec_declaration_product?id=01t0c000008P2yu&m=1
CE EC-Declaration for Industrial/Commercial/ITE	http://globtek.force.com/models/ec_declaration_product?id=01t0c000008P2yu&i=2
CE EC-Declaration for Household	http://globtek.force.com/models/ec_declaration_product?id=01t0c000008P2yu&h=2
UKCA-Declaration for Medical	http://globtek.force.com/models/ukca_declaration_product?id=01t0c000008P2yu&m=1
UKCA-Declaration for Industrial/Commercial/ITE	http://globtek.force.com/models/ukca_declaration_product?id=01t0c000008P2yu&i=2
UKCA-Declaration for Household	http://globtek.force.com/models/ukca_declaration_product?id=01t0c000008P2yu&h=2
Morocco SDoC Declaration	https://globtek.secure.force.com/models/Morocco_SDoC_Declaration?id=a0Oa000000FivPcEAJ
RoHS/RoHS3 Declaration	https://www.globtek.com/pdf/rohs_cert/01t0c000008P2yuAAC
REACH Declaration	https://www.globtek.com/pdf/iso_certificates/REACH.pdf
Conflict Minerals Declaration	https://www.globtek.com/pdf/conflict-minerals.pdf
Prop 65 Statement	https://en.globtek.com/prop-65-statement.pdf
IPXY rating is based on 3rd party testing and customers should check suitability and test system level IPXY rating before ordering.	

Regulatory Certifications/Label Markings

Below follows a link to the latest regulatory certifications and marks for this specific product. National standards as well as certification schemes are constantly changing and so is the set of certification marks and symbols applicable to this product. Various standards, marks and symbols, and certificates are subject to change at any time without notice.

Additional standards or unique country certifications are available upon request. Please contact Globtek to request a quotation.

LATEST PRODUCT/MODEL CERTIFICATIONS:	https://www.globtek.com/datasheet/w70804
AGENCY ONLINE DOCUMENTS	http://www.globtek.info/certs/GTM46402/
	(F1) Class II / Double Insulated

	Center Positive (+V), symbol compliant with IEC 60417 symbol no. 5926
--	---

GlobTek, Inc. www.globtek.com 186 Veterans Drive, Northvale, NJ 07647 Tel. (201) 784-1000 Fax (201) 784-0111	Drawing Title: GTM46402-3509, Medical/ICT/ITE/Household use Power Supply, Efficiency Level: USA DOE Level VI / Eco-design Directive 2009/125/EC, (EU) 2019/1782, Case Color/Style: GlobTek Black, Wall Plug-in, Regulated Switchmode AC-DC Power Supply AC Adaptor, Input Rating: 100-240V~, 50-60 Hz, Interchangeable Blades http://en.globtek.com/interchangeable-blades.php , Output Rating: 35W, 9.0V@3.88A, Output Configuration: 1200 mm, 16/2 Cond, UL 2468, Female Barrel 5.5*2.1*11mm w/ Spring Clip & Locking Notch or Equal, Ferrite: None, GlobTek Black, GT Cord # C17743, Pin Out: Center Positive (+V), symbol compliant with IEC 60417 symbol no. 5926, Blades/Input Cord: (Order Separately), Approvals: cETLus 60950-1; UL 1310; PSE; RCM; cETLus 60601-1 3rd; CB 60335; CB 60950; cETLus 60950; CB 60601-1; Fuse 60335; Fuse 60335; cETLus UL1310; UL 1310; SELV; CB 62368; EAC; LPS 60950; 2MOPP; Korea (15V-24V Only); CCC; PSE; PSE; UKCA; GEMS (24V); UL 1310; Conforms to 62368-1; LPS 62368; ETL 62368; Morocco; Singapore (12V); EAC; India BIS 5.5.95.9,12,13.4,15,18,19,24,48V only; Taiwan BSMI; CE; Ukraine; VCCI; RoHS; Level VI; FCC; CAN ICES-3; IP52; Double Insulation; WEEE; cETLus 60601-1-11;ion; WEEE;	
	Model No. GTM46402-3509	
	Part No./Ordering No. WR9QD3888CCP-N(R6B)	Rev C

PACKAGING

Packing Spec P/N	Cellular packaging, Generic for Q, User Manual
Box Qty	80
Gift Box Size (mm)	Egg crate
Gift Box Color	None
Master Carton Size (mm)	440 x 403 x 300
Master Carton Cubic Volume (m ³)	0.05
Master GW (Kg)	15.2 kg
BLADES INCLUDED	None: (Order Separately)
BLADE/CORD INSTALLED	None: (Order Separately)
USER MANUAL*	809-PSUQKITUSERMANUAL on A4 paper
USER MANUAL WEB LINK	https://en.globtek.com/pdf/809-PSUQKITUSERMANUAL.jpg

* This specification sheet is considered the user manual for all applications. It is expected that the buyer of this product will use it to formulate their own user manual for their end product and a user manual specifically for the power adapter is not usually required. If a user manual is not specifically listed above then none will be provided with this unit.

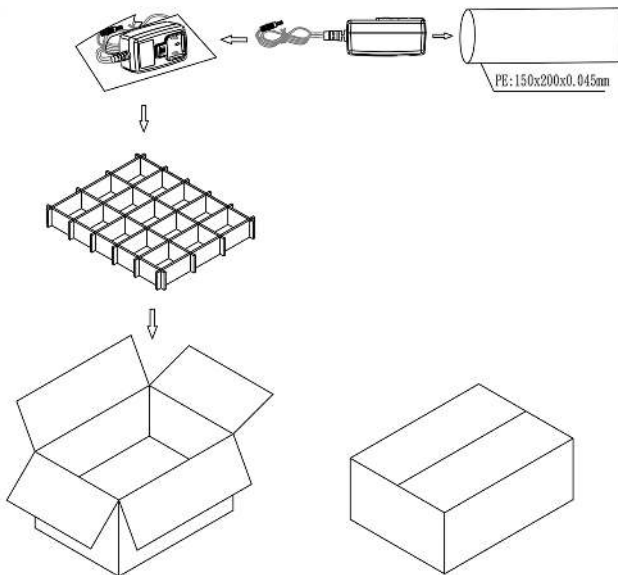

PROPRIETARY INFORMATION

<p>GlobTek, Inc. www.globtek.com 186 Veterans Drive, Northvale, NJ 07647 Tel. (201) 784-1000 Fax (201) 784-0111</p>	<p>Drawing Title: GTM46402-3509, Medical/ICT/ITE/Household use Power Supply, Efficiency Level: USA DOE Level VI / Eco-design Directive 2009/125/EC, (EU) 2019/1782, Case Color/Style: GlobTek Black, Wall Plug-in, Regulated Switchmode AC-DC Power Supply AC Adaptor, Input Rating: 100-240V~, 50-60 Hz, Interchangeable Blades http://en.globtek.com/interchangeable-blades.php, Output Rating: 35W, 9.0V@3.88A, Output Configuration: 1200 mm, 16/2 Cond, UL 2468, Female Barrel 5.5*2.1*11mm w/ Spring Clip & Locking Notch or Equal, Ferrite: None, GlobTek Black, GT Cord # C17743, Pin Out: Center Positive (+V), symbol compliant with IEC 60417 symbol no. 5926, Blades/Input Cord: (Order Separately), Approvals: cETLus 60950-1; UL 1310; PSE; RCM; cETLus 60601-1 3rd; CB 60335; CB 60950; cETLus 60950; CB 60601-1; Fuse 60335; Fuse 60335; cETLus UL1310; UL 1310; SELV; CB 62368; EAC; LPS 60950; 2MOPP; Korea (15V-24V Only); CCC; PSE; PSE; UKCA; GEMS (24V); UL 1310; Conforms to 62368-1; LPS 62368; ETL 62368; Morocco; Singapore (12V); EAC; India BIS 5,5.95,9,12,13.4,15,18,19,24,48V only; Taiwan BSMI; CE; Ukraine; VCCI; RoHS; Level VI; FCC; CAN ICES-3; IP52; Double Insulation; WEEE; cETLus 60601-1-1;ion; WEEE;</p>	
	<p>Model No. GTM46402-3509</p>	
	<p>Part No./Ordering No. WR9QD3888CCP-N(R6B)</p>	<p>Rev C</p>

INSTRUCTIONS TO THE OEM SYSTEMS ENGINEER

It is the responsibility of the OEM systems engineer to provide the end system user instructions and warnings for the use of this product in the end system.

If an input cord is required for this product, AC Mains voltage should be provided to the power supply by a power supply cord approved to the national standards of the country in which it will be used.

This product is not designed to be repaired. No serviceable parts inside. A blown internal fuse is an indication of catastrophic failure of circuit component(s). If a Failure Analysis is required for a failed power supply/battery charger, please return the damaged unit to GlobTek for an accurate determination of the root cause of the failure.

EMC Compliance of the complete OEM product, including the GlobTek power supply/battery charger needs to be verified by the OEM systems engineer.

INSTRUCTION SHEET

Q Blades Instruction Sheet (not required to be packaged with product)

Insertion Instructions: <http://www.globtek.com/pdf/Instructions-Interchangeable-Blades.pdf>

This manual is Provided to customer within the product specification - it is the responsibility of the OEM/customer to provide the end system user instructions + warnings for the use of this product in the end system. By accepting this specification the customer/OEM Agrees to these terms.

USER MANUAL FOR Q-BLADE SERIES SWITCHING POWER SUPPLIES

Manual del Usuario. Fuentes de Alimentación Series Q-Blade

WARNING! RISK OF FIRE! SHOCK HAZARD!: To prevent electric shock, do not remove the cover. No user-serviceable parts inside. This unit contains hazardous voltages and should only be opened by a trained and qualified technician. Do not use if bent, cracked, modified or compromised. To avoid the possibility of electric shock, disconnect electric power to the product before connecting or disconnecting.

Advertencia! Riesgo de Fuego! Peligro de Choque eléctrico! No contiene dentro componentes servibles para el usuario. Desconecte el cable de alimentación antes de quitar la cubierta.

INDOOR USE ONLY!

Únicamente para uso en el interior.

POWER SUPPLY BLADE/CORD: AC Mains voltage should be provided to the power supply by a power supply cords approved to the national standards in which it will be used. Please use the below table as a guideline for Suitable Power cords.

GlobTek, Inc. www.globtek.com 186 Veterans Drive, Northvale, NJ 07647 Tel. (201) 784-1000 Fax (201) 784-0111	Drawing Title: GTM46402-3509, Medical/ICT/ITE/Household use Power Supply, Efficiency Level: USA DOE Level VI / Eco-design Directive 2009/125/EC, (EU) 2019/1782, Case Color/Style: GlobTek Black, Wall Plug-in, Regulated Switchmode AC-DC Power Supply AC Adaptor, Input Rating: 100-240V~, 50-60 Hz, Interchangeable Blades http://en.globtek.com/interchangeable-blades.php , Output Rating: 35W, 9.0V@3.88A, Output Configuration: 1200 mm, 16/2 Cond, UL 2468, Female Barrel 5.5*2.1*11mm w/ Spring Clip & Locking Notch or Equal, Ferrite: None, GlobTek Black, GT Cord # C17743, Pin Out: Center Positive (+V), symbol compliant with IEC 60417 symbol no. 5926, Blades/Input Cord: (Order Separately), Approvals: cETLus 60950-1; UL 1310; PSE; RCM; cETLus 60601-1 3rd; CB 60335; CB 60950; cETLus 60950; CB 60601-1; Fuse 60335; Fuse 60335; cETLus UL1310; UL 1310; SELV; CB 62368; EAC; LPS 60950; 2MOPP; Korea (15V-24V Only); CCC; PSE; PSE; UKCA; GEMS (24V); UL 1310; Conforms to 62368-1; LPS 62368; ETL 62368; Morocco; Singapore (12V); EAC; India BIS 5.5.95.9,12,13.4,15,18,19,24,48V only; Taiwan BSMI; CE; Ukraine; VCCI; RoHS; Level VI; FCC; CAN ICES-3; IP52; Double Insulation; WEEE; cETLus 60601-1-1;ion; WEEE;	
	Model No. GTM46402-3509	
	Part No./Ordering No. WR9QD3888CCP-N(R6B)	Rev C

CABLE DE ALIMENTACIÓN: El voltaje de la CA debe proporcionarse a la fuente de alimentación mediante los cables de alimentación aprobados conforme a las normas nacionales según las cuales será utilizada. Utilice por favor la tabla mencionada aquí abajo como guía para los cables eléctricos adecuados.

1. Class II model NEMA 1-15P AC power plug with 2 prongs, Q-NA(R)
2. Australian AS 3112 configuration: SAA 2 pins Class II, Q-SAA(R)
3. UK BS 1363 configuration: UK 2 pins Class II, Q-UK(R)
4. European CEE 7/16 configuration: Europlug 2 PINS, Class II, Q-EU(R)
5. Korean KS C8305 configuration: Q-KR(R)
6. Argentina IRAM 2073 configuration: 2 pins, Class II Q-AR(R)
7. China GR 2099 configuration: 2 pins, Class II Q-CN(R)
8. India configuration: 2 pins, Class II, Q-IN(R)
9. IEC320/C18 Inlet

FUSING: Internal fuse for Line is provided in the power supply. A blown internal fuse is an indication of catastrophic failure of circuit component(s). Repair must be performed by GlobTek, Inc. authorized personnel. Fuses must be replaced with same type and ratings per GlobTek internal documentation.

FUSIBLES: La fuente de alimentación provee un fusible interno para la línea. Un fusible interno quemado es un indicador de una falla catastrófica de los componentes del circuito. La reparación debe ser hecha por personal autorizado de GlobTek, Inc. Los fusibles se deben reemplazar por los mismos tipos y rangos que la documentación interna de GlobTek mencione.

GlobTek, Inc.
www.globtek.com
186 Veterans Drive,
Northvale, NJ 07647
Tel. (201) 784-1000
Fax (201) 784-0111

Drawing Title: GTM46402-3509, Medical/ICT/ITE/Household use Power Supply, Efficiency Level: USA DOE Level VI / Eco-design Directive 2009/125/EC, (EU) 2019/1782, Case Color/Style: GlobTek Black, Wall Plug-in, Regulated Switchmode AC-DC Power Supply AC Adaptor, Input Rating: 100-240V~, 50-60 Hz, Interchangeable Blades <http://en.globtek.com/interchangeable-blades.php>, Output Rating: 35W, 9.0V@3.88A, Output Configuration: 1200 mm, 16/2 Cond, UL 2468, Female Barrel 5.5*2.1*11mm w/ Spring Clip & Locking Notch or Equal, Ferrite: None, GlobTek Black, GT Cord # C17743, Pin Out: Center Positive (+V), symbol compliant with IEC 60417 symbol no. 5926, Blades/Input Cord: (Order Separately), Approvals: cETLus 60950-1; UL 1310; PSE; RCM; cETLus 60601-1 3rd; CB 60335; CB 60950; cETLus 60950; CB 60601-1; Fuse 60335; Fuse 60335; cETLus UL1310; UL 1310; SELV; CB 62368; EAC; LPS 60950; 2MOPP; Korea (15V-24V Only); CCC; PSE; PSE; UKCA; GEMS (24V); UL 1310; Conforms to 62368-1; LPS 62368; ETL 62368; Morocco; Singapore (12V); EAC; India BIS 5.5.95.9,12,13.4,15,18,19,24,48V only; Taiwan BSMI; CE; Ukraine; VCCI; RoHS; Level VI; FCC; CAN ICES-3; IP52; Double Insulation; WEEE; cETLus 60601-1-1;ion; WEEE;

Model No. GTM46402-3509

Part No./Ordering No. WR9QD3888CCP-N(R6B)

Rev C

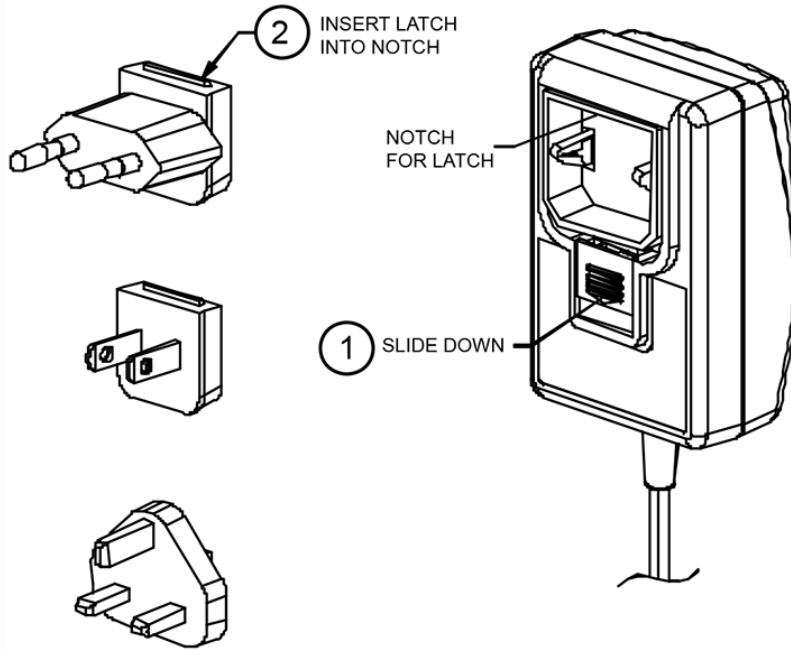

This symbol on an instrument indicates that the user should refer to the operating instructions located in the manual.

Please note:

The blades shown above are for representation of the installation process and do not indicate which AC blades are included with this power supply. Please reference the specifications "Power Supply Information" (page 2) and "Input Configuration" (page 6) for information regarding the actual blade included with this power supply, if any.

<p>GlobTek, Inc. www.globtek.com 186 Veterans Drive, Northvale, NJ 07647 Tel. (201) 784-1000 Fax (201) 784-0111</p>	<p>Drawing Title: GTM46402-3509, Medical/ICT/ITE/Household use Power Supply, Efficiency Level: USA DOE Level VI / Eco-design Directive 2009/125/EC, (EU) 2019/1782, Case Color/Style: GlobTek Black, Wall Plug-in, Regulated Switchmode AC-DC Power Supply AC Adaptor, Input Rating: 100-240V~, 50-60 Hz, Interchangeable Blades http://en.globtek.com/interchangeable-blades.php, Output Rating: 35W, 9.0V@3.88A, Output Configuration: 1200 mm, 16/2 Cond, UL 2468, Female Barrel 5.5*2.1*11mm w/ Spring Clip & Locking Notch or Equal, Ferrite: None, GlobTek Black, GT Cord # C17743, Pin Out: Center Positive (+V), symbol compliant with IEC 60417 symbol no. 5926, Blades/Input Cord: (Order Separately), Approvals: cETLus 60950-1; UL 1310; PSE; RCM; cETLus 60601-1 3rd; CB 60335; CB 60950; cETLus 60950; CB 60601-1; Fuse 60335; Fuse 60335; cETLus UL1310; UL 1310; SELV; CB 62368; EAC; LPS 60950; 2MOPP; Korea (15V-24V Only); CCC; PSE; PSE; UKCA; GEMS (24V); UL 1310; Conforms to 62368-1; LPS 62368; ETL 62368; Morocco; Singapore (12V); EAC; India BIS 5,5.95,9,12,13.4,15,18,19,24,48V only; Taiwan BSMI; CE; Ukraine; VCCI; RoHS; Level VI; FCC; CAN ICES-3; IP52; Double Insulation; WEEE; cETLus 60601-1-11;ion; WEEE;</p>
	<p>Model No. GTM46402-3509</p>
	<p>Part No./Ordering No. WR9QD3888CCP-N(R6B) Rev C</p>

