

DRAWING FOR REFERENCE
 WE RESERVE THE RIGHT TO MAKE CHANGES TO OUR
 STANDARD PRODUCTS. PLEASE CONSULT WITH BUD INDUSTRIES
 PRIOR TO USING THIS DRAWING FOR DESIGN PURPOSE.

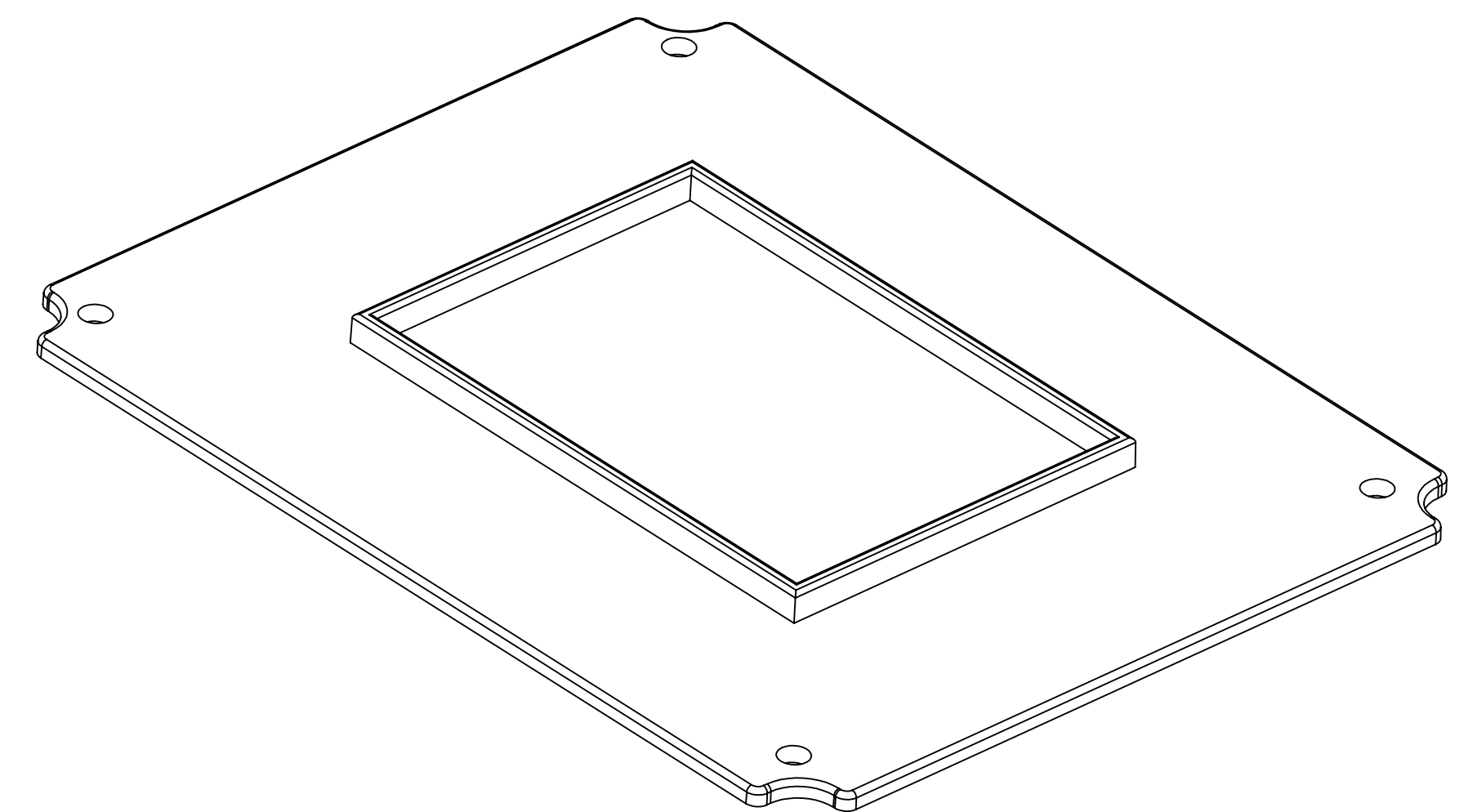
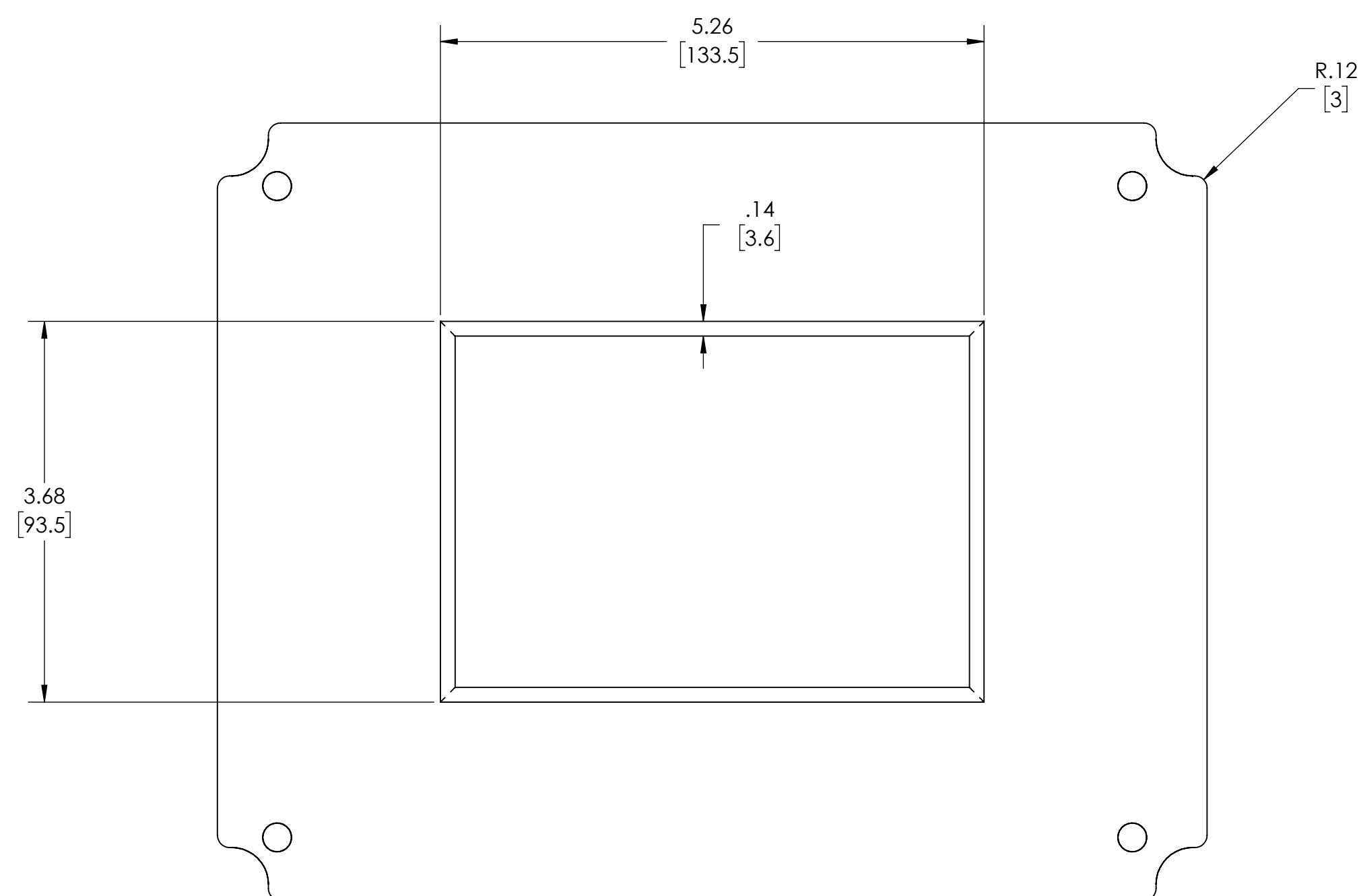
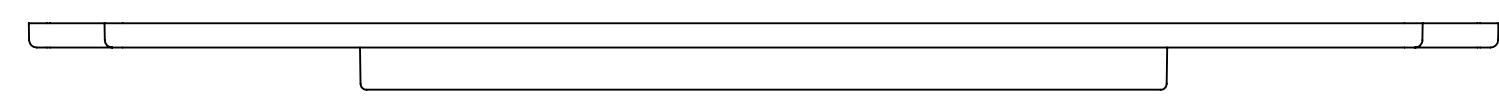
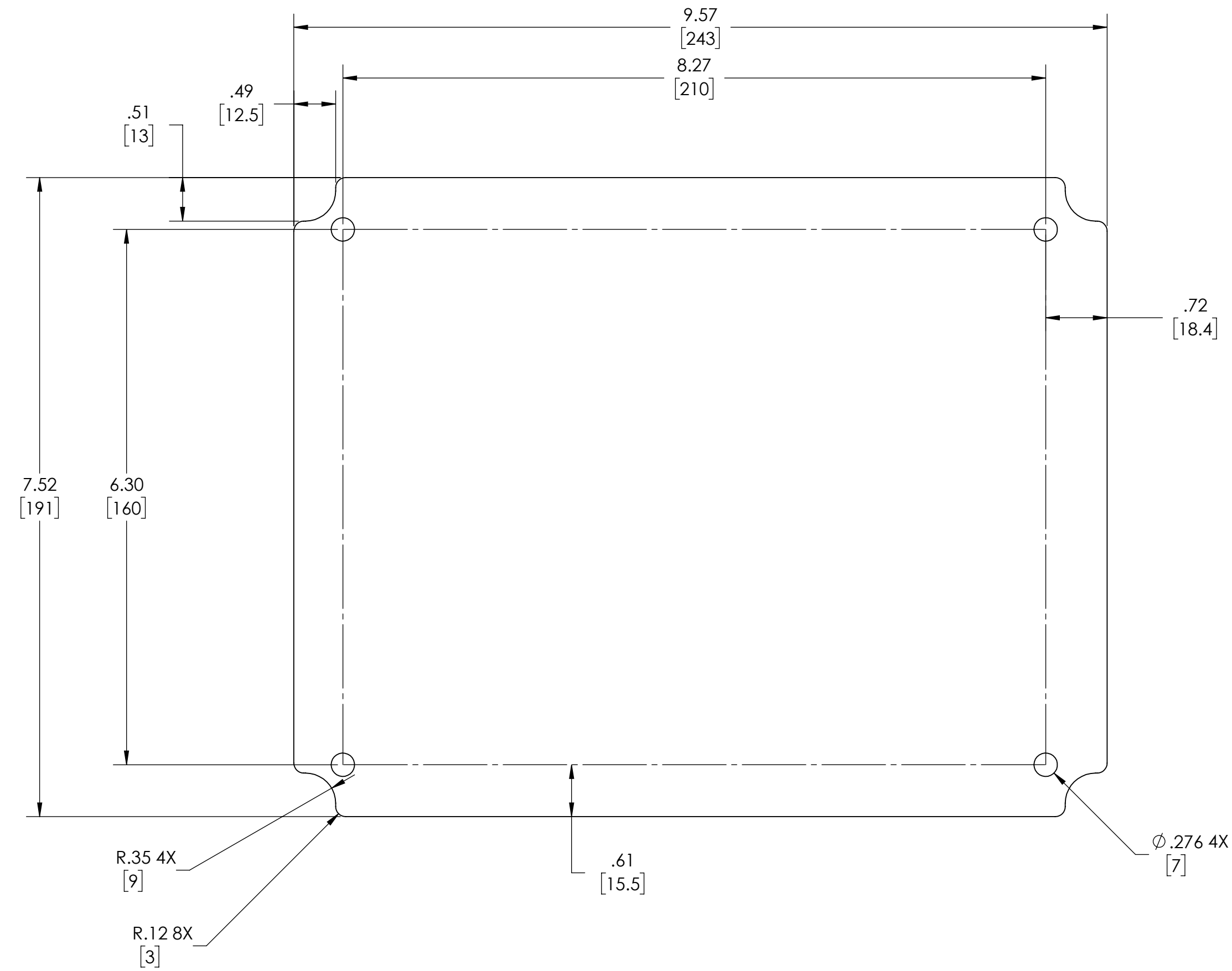

MATERIAL - ABS PLASTIC
 FINISH - LIGHT GRAY
 DIMENSIONS ARE INCH[MM]
 PANEL FITS THE FOLLOWING ENCLOSURES:
 PTH-22422 & PTH-22422-C