



Typical Applications

The HMC194MS8 /HMC194MS8E is ideal for:

- Cellular/PCS Base Stations
- Portable Wireless
- MMDS & WirelessLAN

Features

- Ultra Small Package: MSOP8
- High Isolation: 50 dB
- Positive Control: 0/+3V to 0/+7V

Functional Diagram

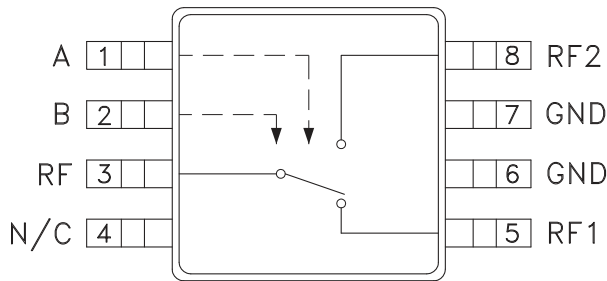

General Description

The HMC194MS8 & HMC194MS8E are low-cost SPDT switches in 8-lead MSOP packages for use in applications which require high isolation between two RF paths. The devices can control signals from DC to 3 GHz and have been optimized to provide extremely high isolation with minimal insertion loss in medium and low power applications. On chip circuitry allows positive voltage control operation at very low DC currents with control inputs compatible with CMOS and most TTL logic families. RF1 and RF2 are reflective opens when "OFF".

Electrical Specifications, $T_A = +25^\circ C$, $V_{ctl} = 0/+5 Vdc$, 50 Ohm System

Parameter	Frequency	Min.	Typ.	Max.	Units
Insertion Loss	DC - 2.0 GHz		0.7	0.9	dB
	DC - 2.5 GHz		0.8	1.0	dB
	DC - 3.0 GHz		0.8	1.1	dB
Isolation	RF1 / RF2	DC - 1.0 GHz	48 / 50	52 / 54	dB
	RF1 / RF2	DC - 2.0 GHz	40 / 42	44 / 46	dB
		DC - 2.5 GHz	31	35	dB
		DC - 3.0 GHz	24	28	dB
Return Loss	DC - 2.0 GHz		24		dB
	DC - 2.5 GHz		22		dB
Input Power for 1 dB Compression 0/+5V Control	0.5 - 3.0 GHz	24	28		dBm
Input Third Order Intercept (Two-tone Input Power = +7 dBm Each Tone) 0/+5V Control	0.5 - 3.0 GHz	49	53		dBm
Switching Characteristics	DC - 3.0 GHz		tRISE, tFALL (10/90% RF)	10	ns
			tON , tOFF (50% CTL to 10/90% RF)	24	ns

Information furnished by Analog Devices is believed to be accurate and reliable. However, no responsibility is assumed by Analog Devices for its use, nor for any infringements of patents or other rights of third parties that may result from its use. Specifications subject to change without notice. No license is granted by implication or otherwise under any patent or patent rights of Analog Devices. Trademarks and registered trademarks are the property of their respective owners.

For price, delivery, and to place orders: Analog Devices, Inc., One Technology Way, P.O. Box 9106, Norwood, MA 02062-9106
Phone: 781-329-4700 • Order online at www.analog.com
Application Support: Phone: 1-800-ANALOG-D



GaAs MMIC SPDT SWITCH DC - 3 GHz

Insertion Loss

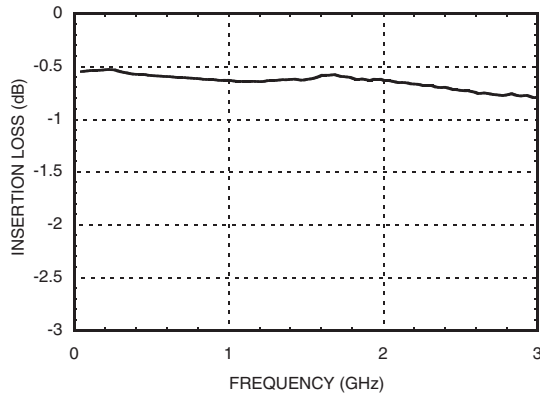

Isolation

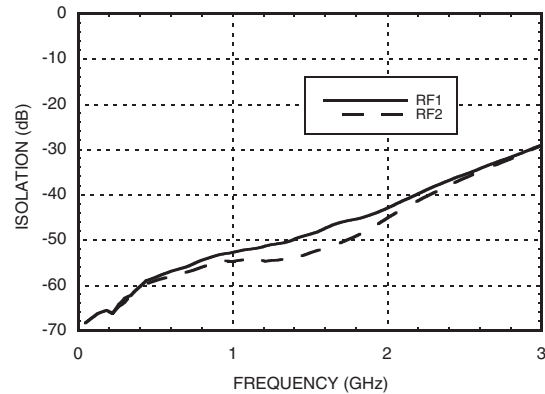

Return Loss

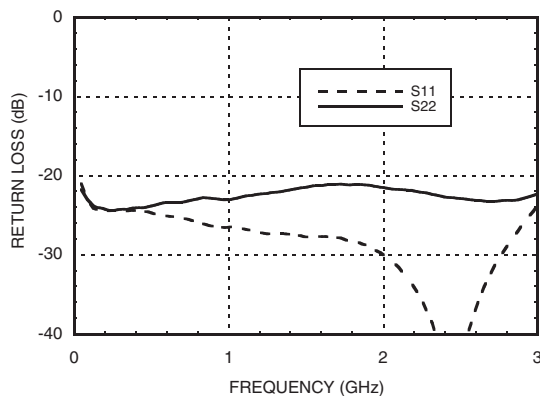

Input 0.1 and 1.0 dB Compression vs. Control Voltage

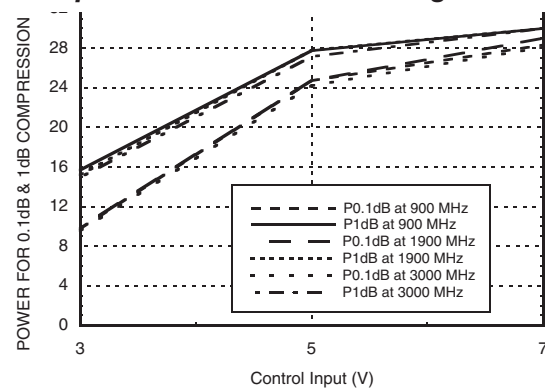

Input Third Order Intercept Point vs. Control Voltage

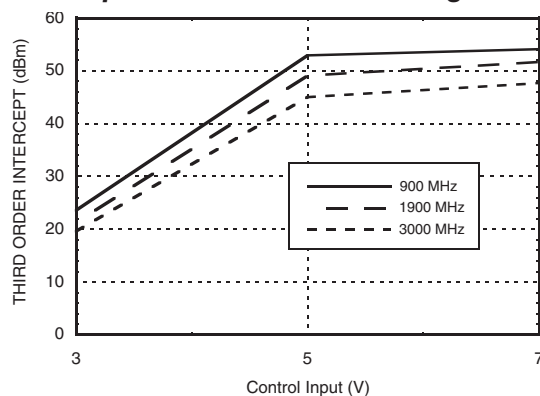

Truth Table

*Control Input Voltage Tolerances are ± 0.2 Vdc.

Control Input*		Control Current		Signal Path State	
A (Vdc)	B (Vdc)	Ia (μ A)	Ib (μ A)	RF to RF1	RF to RF2
0	+3	-0.05	+0.05	ON	OFF
+3	0	+0.05	-0.05	OFF	ON
0	+5	-2	+2	ON	OFF
+5	0	+2	-2	OFF	ON
0	+7	-15	+15	ON	OFF
+7	0	+15	-15	OFF	ON

Information furnished by Analog Devices is believed to be accurate and reliable. However, no responsibility is assumed by Analog Devices for its use, nor for any infringements of patents or other rights of third parties that may result from its use. Specifications subject to change without notice. No license is granted by implication or otherwise under any patent or patent rights of Analog Devices. Trademarks and registered trademarks are the property of their respective owners.

For price, delivery, and to place orders: Analog Devices, Inc., One Technology Way, P.O. Box 9106, Norwood, MA 02062-9106 Phone: 781-329-4700 • Order online at www.analog.com Application Support: Phone: 1-800-ANALOG-D



GaAs MMIC SPDT SWITCH DC - 3 GHz

Absolute Maximum Ratings

RF Input Power (Vctl= 0V/+5V)	+27 dBm
Control Voltage Range (A & B)	-0.2 to +7.5 Vdc
Hot Switch Power Level (Vctl= 0V/+5V)	+24 dBm
Channel Temperature	150 °C
Continuous P _{diss} (T= 85 °C) (derate 5.5 mW/°C above 85 °C)	360 mW
Thermal Resistance	180 °C/W
Storage Temperature	-65 to +150 °C
Operating Temperature	-40 to +85 °C
ESD Sensitivity (HBM)	Class 1B



ELECTROSTATIC SENSITIVE DEVICE
OBSERVE HANDLING PRECAUTIONS

Note: DC blocking capacitors are required at ports RFC, RF1 and RF2. Their value will determine the lowest transmission frequency.

Outline Drawing

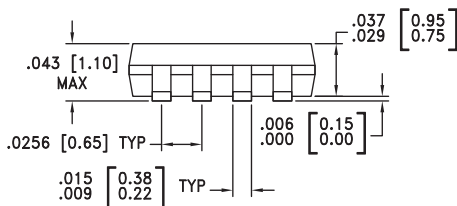
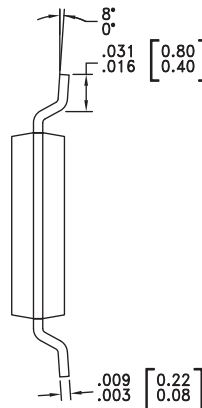
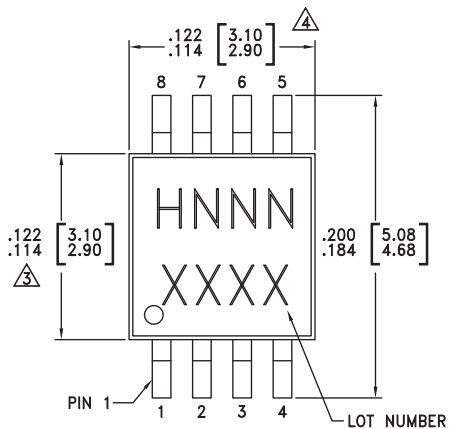

NOTES:

- LEADFRAME MATERIAL: COPPER ALLOY
- DIMENSIONS ARE IN INCHES [MILLIMETERS].
- DIMENSION DOES NOT INCLUDE MOLDFLASH OF 0.15mm PER SIDE.
- DIMENSION DOES NOT INCLUDE MOLDFLASH OF 0.25mm PER SIDE.
- ALL GROUND LEADS MUST BE SOLDERED TO PCB RF GROUND.
- CLASSIFIED AS MOISTURE SENSITIVITY LEVEL (MSL) 1.

Package Information

Part Number	Package Body Material	Lead Finish	MSL Rating	Package Marking ^[3]
HMC194MS8	Low Stress Injection Molded Plastic	Sn/Pb Solder	MSL1 ^[1]	H194 XXXX
HMC194MS8E	RoHS-compliant Low Stress Injection Molded Plastic	100% matte Sn	MSL1 ^[2]	H194 XXXX

[1] Max peak reflow temperature of 235 °C

[2] Max peak reflow temperature of 260 °C

[3] 4-Digit lot number XXXX



Typical Application Circuit

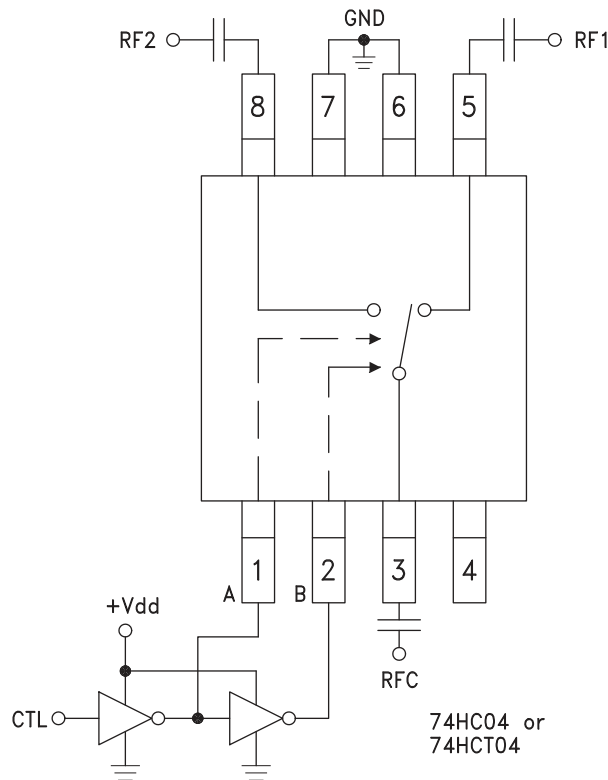

Notes:

1. Set logic gate and switch Vdd = +3V to +5V and use HCT series logic to provide a TTL driver interface.
2. Control inputs A/B can be driven directly with CMOS logic (HC) with Vdd of 3 to 7 Volts applied to the CMOS logic gates.
3. DC Blocking capacitors are required for each RF port as shown. Capacitor value determines lowest frequency of operation.
4. Highest RF signal power capability is achieved with Control set to 0/+7V.



Evaluation Circuit Board

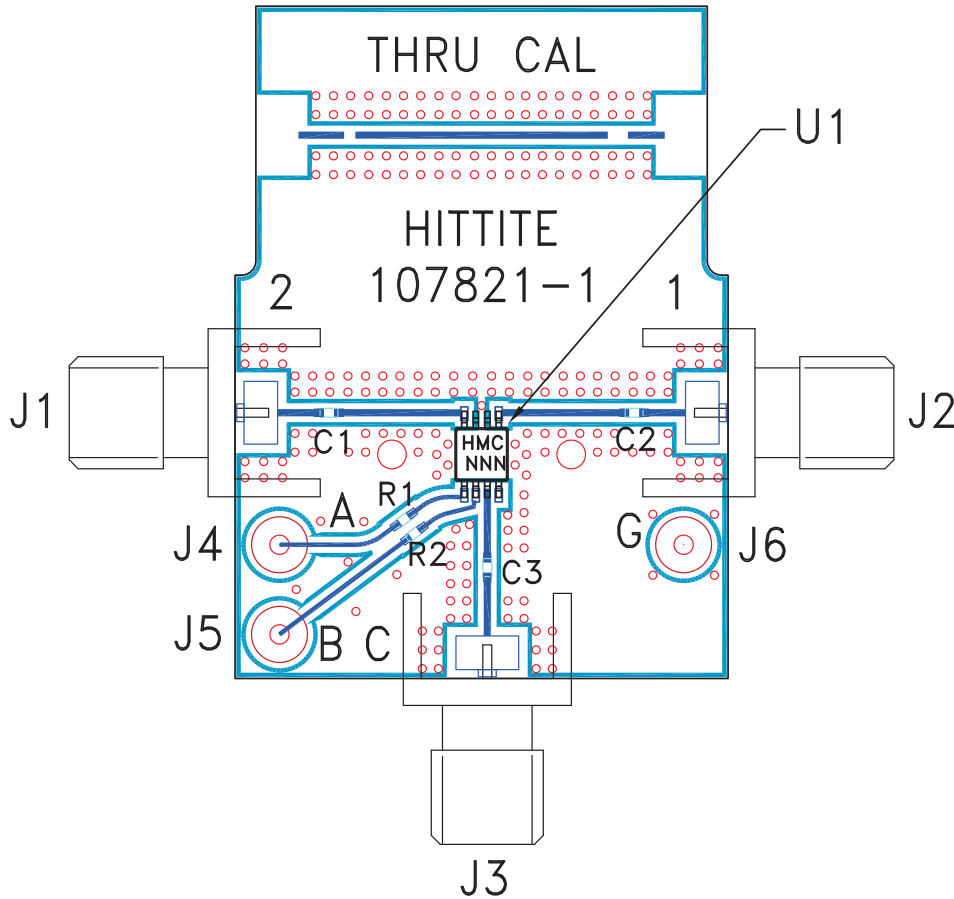

List of Materials for Evaluation PCB 105143 [1]

Item	Description
J1 - J3	PC Mount SMA RF Connector
J4 - J6	DC Pin
C1 - C3	100 pF capacitor, 0402 Pkg.
R1, R2	100 Ω resistor, 0402 Pkg.
U1	HMC194MS8 / HMC194MS8E SPDT Switch
PCB [2]	107821 Evaluation PCB

[1] Reference this number when ordering complete evaluation PCB

[2] Circuit Board Material: Rogers 4350

The circuit board used in the final application should be generated with proper RF circuit design techniques. Signal lines at the RF port should have 50 ohm impedance and the package ground leads should be connected directly to the ground plane similar to that shown above. The evaluation circuit board shown above is available from Hittite Microwave Corporation upon request.

**GaAs MMIC SPDT SWITCH
DC - 3 GHz****Notes**