

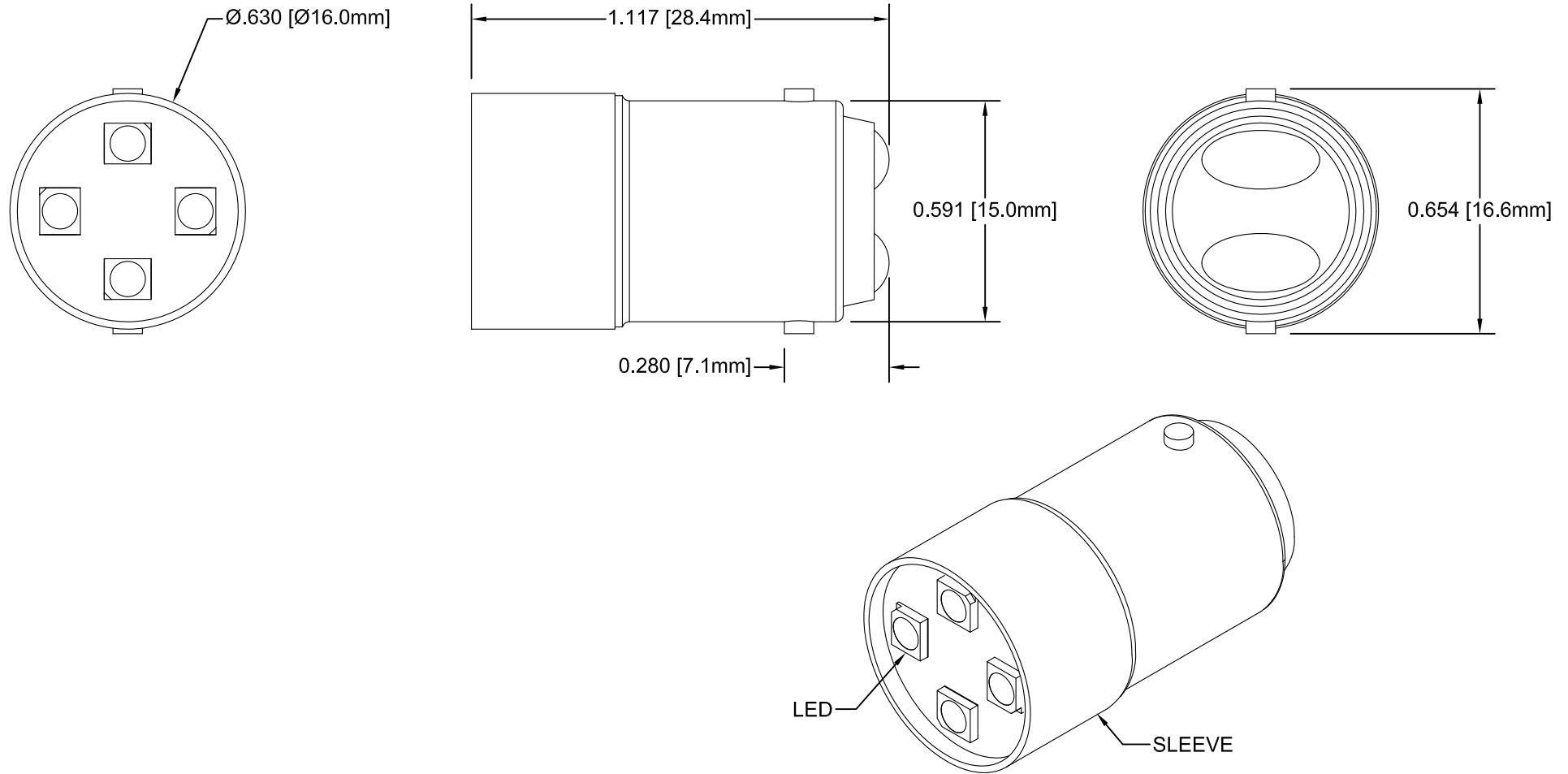

REV.	DESCRIPTION	DATE	APPROVED
A	Engineering Release	10/22/13	G. W.



NOTES:
 2. DIRECT REPLACEMENT FOR BA15d BASED LAMPS
 1. VOLTAGE OPERATING RANGE, 8-48VAC/DC

STANDARD TOLERANCE (UNLESS OTHERWISE SPECIFIED)		 4 THOMAS, IRVINE, CA. 92618 TEL: (949) 951-8808 FAX: (949) 951-3974	
DECIMALS	ANGULAR		
.X ± .1	X° ± 1°		TITLE: 240 SERIES INCANDESCENT REPLACEMENT LEDS
.XX ± .02			PART NO: LFR-240X-XXX
.XXX ± .010			REVISION: A
DESIGNED: Minh Doan	DATE: 10/22/13	CAGE CODE : 32559	SHEET # 1 OF 2
CHECKED: Alex Wright	DATE: 10/22/13	CAD GENERATED DOCUMENT, DO NOT MEASURE DRAWING.	

REV.	DESCRIPTION	DATE	APPROVED
	SEE SHEET #1		

DERATING CURVES

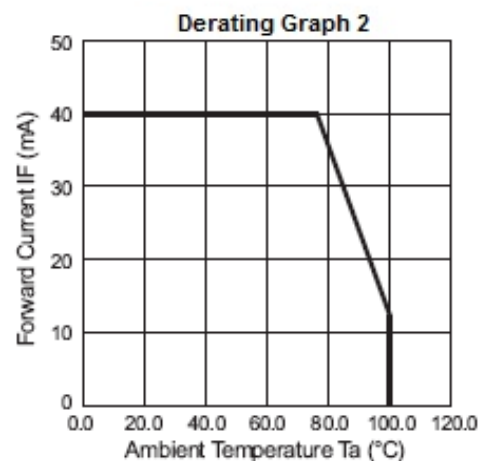
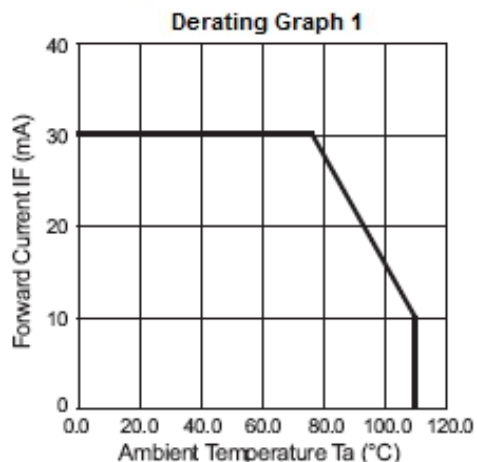



Bivar Part Number	Wave Length λ_p (nm)	Emitted Color	Lens Appearance	Operating Voltage	Electro-Optical Data		Viewing Angle	De-rating Graphs
				Vopr (Vac/dc)	Current DC (mA)	Iv (mcd)		
				TYP	TYP	TYP		
LFR-240A48V	600	AMBER	-	8-48	10	690	120	1
LFR-240R48V	640	RED	-	8-48	10	64	120	2
LFR-240G48V	520	GREEN	-	8-48	10	870	120	1
LFR-240B48V	460	BLUE	-	8-48	10	310	120	1
LFR-240A130VAC	600	AMBER	-	48-130	5	690	120	1
LFR-240R130VAC	640	RED	-	48-130	5	640	120	2
LFR-240G130VAC	520	GREEN	-	48-130	5	870	120	1
LFR-240B130VAC	460	BLUE	-	48-130	5	310	120	1

Bivar Part Number	Chromaticity Coordinates	Emitted Color	Lens Appearance	Operating Voltage	Electro-Optical Data		Viewing Angle	De-rating Graphs
				Vopr (Vac/dc)	Current DC (mA)	Iv (mcd)		
				TYP	TYP	TYP		
LFR-240WW48V	X=0.4255~0.4680 Y=0.4000~0.4385	WARM WHITE	-	8-48	10	1300	120	1
LFR-240WW130VAC	X=0.4255~0.4680 Y=0.4000~0.4385	WARM WHITE	-	8-48	10	1300	120	1
LFR-240CW48V	X=0.264~0.296 Y=0.248~0.305	COOL WHITE	-	48-130	5	1500	120	1
LFR-240CW130VAC	X=0.264~0.296 Y=0.248~0.305	COOL WHITE	-	48-130	5	1500	120	1

ABSOLUTE MAXIMUM RATINGS (Ta = 25°C)

MAXIMUM POWER DISSIPATION _____ 225 mW
 OPERATING TEMPERATURE RANGE _____ -40°C ~ 110°C
 STORAGE TEMPERATURE _____ -40°C ~ 110°C

STANDARD TOLERANCE (UNLESS OTHERWISE SPECIFIED)		 4 THOMAS, IRVINE, CA. 92618 TEL: (949) 951-8808 FAX: (949) 951-3974	
DECIMALS	ANGULAR		
DESIGNED: Minh Doan CHECKED: Alex Wright			TITLE: 240 SERIES INCANDESCENT REPLACEMENT LED
		DATE: 10/22/13	REVISION: A
DATE: 10/22/13		PART NO: LFR-240X-XXX CAGE CODE : 32559 SHEET # 2 OF 2	
CAD GENERATED DOCUMENT, DO NOT MEASURE DRAWING.			