

## High-Precision, Low-Dropout SOT23 Series Voltage Reference

### General Description

The MAX6033 ultra-high-precision series voltage reference features a low 7ppm/°C (max) temperature coefficient and a low dropout voltage (200mV, max). Low temperature drift and low noise make the MAX6033 ideal for use with high-resolution ADCs or DACs.

This device uses bandgap technology for low-noise performance and excellent accuracy. Laser-trimmed, high-stability, thin-film resistors, and postpackage trimming guarantee excellent initial accuracy ( $\pm 0.04\%$ , max). The MAX6033 consumes only 40 $\mu$ A of supply current and sources up to 15mA. Series mode references save system power and use minimal external components compared to two-terminal shunt references.

The MAX6033 is available in the miniature 6-pin SOT23 package and is offered over the automotive temperature range (-40°C to +125°C).

### Applications

Precision Regulators  
A/D and D/A Converters  
Power Supplies  
Hard-Disk Drives  
High-Accuracy Industrial and Process Control  
Hand-Held Instruments

*Typical Operating Circuit appears at end of data sheet.*

### Features

- ◆ Tiny 6-Pin SOT23 Package
- ◆ Ultra-Low Temperature Drift: 7ppm/°C (max)
- ◆  $\pm 0.04\%$  Initial Accuracy
- ◆ Stable with Capacitive Loads
- ◆ Low 16 $\mu$ V<sub>P-P</sub> Noise (0.1Hz to 10Hz) (2.5V Output)
- ◆ 15mA Output Source Current
- ◆ Low 200mV Dropout Voltage
- ◆ Low 40 $\mu$ A Quiescent Current
- ◆ Wide 2.7V to 12.6V Supply Voltage
- ◆ Excellent Load Regulation: 0.001mV/mA

### Pin Configuration

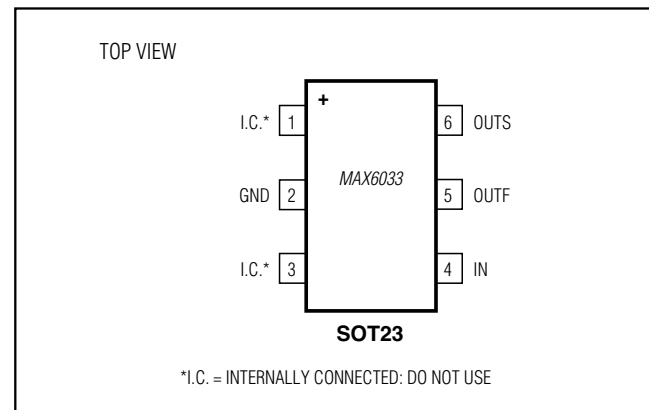

### Ordering Information/Selector Guide

| PART               | OUTPUT VOLTAGE (V) | TEMP COEFF (ppm/°C) | INITIAL ACCURACY (%) | TOP MARK |
|--------------------|--------------------|---------------------|----------------------|----------|
| MAX6033AAUT25-T    | 2.500              | 10                  | 0.04                 | ABDF     |
| MAX6033AAUT25#TG16 | 2.500              | 10                  | 0.04                 | #ACNC    |
| MAX6033BAUT25-T    | 2.500              | 15                  | 0.20                 | AAXL     |
| MAX6033BAUT25#TG16 | 2.500              | 15                  | 0.20                 | #ACND    |
| MAX6033CAUT25-T    | 2.500              | 40                  | 0.10                 | AAXH     |
| MAX6033CAUT25#TG16 | 2.500              | 40                  | 0.10                 | #ACNE    |
| MAX6033AAUT30-T    | 3.000              | 10                  | 0.04                 | ABDG     |
| MAX6033AAUT30#TG16 | 3.000              | 10                  | 0.04                 | #ACNF    |
| MAX6033BAUT30-T    | 3.000              | 15                  | 0.20                 | AAXM     |
| MAX6033BAUT30#TG16 | 3.000              | 15                  | 0.20                 | #ACNG    |

*Ordering Information/Selector Guide continued on last page.*

#Denotes a RoHS-compliant device that may include lead(Pb) that is exempt under the RoHS requirements.

T = Tape and reel.

**For pricing, delivery, and ordering information, please contact Maxim Direct at 1-888-629-4642, or visit Maxim's website at [www.maximintegrated.com](http://www.maximintegrated.com).**

# MAX6033

## Ultra-High-Precision SOT23 Series Voltage Reference

### ABSOLUTE MAXIMUM RATINGS

IN to GND .....-0.3V to +13V  
 OUTF, OUTS to GND.....-0.3V to +6V  
 Continuous Power Dissipation (T<sub>A</sub> = +70°C)  
 6-Pin SOT23 (derate 9.1mW/°C above +70°C).....727mW  
 Operating Temperature Range .....-40°C to +125°C  
 Storage Temperature Range .....-65°C to +150°C

Maximum Junction Temperature .....+150°C  
 Lead Temperature (soldering, 10s).....+300°C  
 Soldering Temperature (reflow)  
 RoHS-Compliant Packages .....+245°C  
 Packages Containing Lead(Pb).....+240°C

Stresses beyond those listed under "Absolute Maximum Ratings" may cause permanent damage to the device. These are stress ratings only, and functional operation of the device at these or any other conditions beyond those indicated in the operational sections of the specifications is not implied. Exposure to absolute maximum rating conditions for extended periods may affect device reliability.

### ELECTRICAL CHARACTERISTICS—V<sub>OUT</sub> = 2.500V

(V<sub>IN</sub> = 5V, C<sub>OUT</sub> = 0.1μF, I<sub>OUT</sub> = 0A, T<sub>A</sub> = T<sub>MIN</sub> to T<sub>MAX</sub>, unless otherwise specified. Typical values are at T<sub>A</sub> = +25°C.) (Note 1)

| PARAMETER                              | SYMBOL                               | CONDITIONS  |                                  | MIN    | TYP    | MAX    | UNITS             |
|--|--------------------------------------|---|----------------------------------|--------|--------|--------|-------------------|
| Output Voltage                         | V <sub>OUT</sub>                     | T <sub>A</sub> = +25°C                              | MAX6033A                         | 2.4990 | 2.5000 | 2.5010 | V                 |
|  |                                      |   | MAX6033B                         | 2.4950 | 2.5000 | 2.5050 |                   |
|  |                                      |   | MAX6033C                         | 2.4975 | 2.5000 | 2.5025 |                   |
| Output-Voltage Accuracy                |                                      | T <sub>A</sub> = +25°C                              | MAX6033A                         | -0.04  |        | +0.04  | %                 |
|  |                                      |   | MAX6033B                         | -0.2   |        | +0.2   |                   |
|  |                                      |   | MAX6033C                         | -0.1   |        | +0.1   |                   |
| Output Voltage Temperature Coefficient | TCV <sub>OUT</sub>                   | MAX6033A  | T <sub>A</sub> = -40°C to +85°C  |        | 1.5    | 7      | ppm/°C            |
|  |                                      |   | T <sub>A</sub> = -40°C to +125°C |        | 2.5    | 10     |                   |
|  |                                      | MAX6033B  | T <sub>A</sub> = -40°C to +85°C  |        | 3      | 10     |                   |
|  |                                      |   | T <sub>A</sub> = -40°C to +125°C |        | 7      | 15     |                   |
|  |                                      | MAX6033C  | T <sub>A</sub> = -40°C to +85°C  |        | 6      | 20     |                   |
|  |                                      |   | T <sub>A</sub> = -40°C to +125°C |        | 10     | 40     |                   |
| Input Voltage Range                    | V <sub>IN</sub>                      | Inferred from line regulation specification         |                                  | 2.7    |        | 12.6   | V                 |
| Line Regulation                        | ΔV <sub>OUT</sub> /ΔV <sub>IN</sub>  | 2.7V ≤ V <sub>IN</sub> ≤ 12.6V                      | T <sub>A</sub> = +25°C           |        | 3      | 25     | μV/V              |
|  |                                      |   | T <sub>A</sub> = -40°C to +125°C |        |        | 50     |                   |
| Load Regulation                        | ΔV <sub>OUT</sub> /ΔI <sub>OUT</sub> | -100μA ≤ I <sub>OUT</sub> ≤ 15mA                    | T <sub>A</sub> = +25°C           |        | 0.001  | 0.05   | mV/mA             |
|  |                                      |   | T <sub>A</sub> = -40°C to +125°C |        |        | 0.1    |                   |
| Dropout Voltage (Note 2)               | V <sub>DO</sub>                      | V <sub>OUT</sub> = 0.1%, I <sub>OUT</sub> = 1mA     |                                  |        | 0.02   | 0.2    | V                 |
|  |                                      | V <sub>OUT</sub> = 0.1%,<br>I <sub>OUT</sub> = 10mA | T <sub>A</sub> = -40°C to +85°C  |        | 0.3    | 0.4    |                   |
|  |                                      |   | T <sub>A</sub> = -40°C to +125°C |        |        | 0.5    |                   |
| Quiescent Supply Current               | I <sub>IN</sub>                      | T <sub>A</sub> = +25°C                              |                                  |        | 40     | 60     | μA                |
|  |                                      | T <sub>A</sub> = -40°C to +85°C                     |                                  |        |        | 75     |                   |
|  |                                      | T <sub>A</sub> = -40°C to +125°C                    |                                  |        |        | 85     |                   |
| Output Short-Circuit Current           | I <sub>SC</sub>                      | V <sub>OUT</sub> = 0V                               |                                  |        | 90     |        | mA                |
|  |                                      | V <sub>OUT</sub> = V <sub>IN</sub>                  |                                  |        | -2     |        |                   |
| Output-Voltage Noise                   | e <sub>n</sub>                       | 0.1Hz ≤ f ≤ 10Hz                                    |                                  |        | 16     |        | μV <sub>P-P</sub> |
|  |                                      | 10Hz ≤ f ≤ 1kHz                                     |                                  |        | 12     |        | μV <sub>RMS</sub> |
| Turn-On Settling Time                  | t <sub>ON</sub>                      | V <sub>OUT</sub> settles to ±0.01% of final value   |                                  |        | 500    |        | μs                |
| Temperature Hysteresis                 |                                      | (Note 3)  |                                  |        | 150    |        | ppm               |
| Long-Term Stability                    |                                      | Δt = 1000hr   |                                  |        | 40     |        | ppm               |

# MAX6033

## Ultra-High-Precision SOT23 Series Voltage Reference

### ELECTRICAL CHARACTERISTICS— $V_{OUT} = 3.000V$

( $V_{IN} = 5V$ ,  $C_{OUT} = 0.1\mu F$ ,  $I_{OUT} = 0A$ ,  $T_A = T_{MIN}$  to  $T_{MAX}$ , unless otherwise specified. Typical values are at  $T_A = +25^\circ C$ .) (Note 1)

| PARAMETER                              | SYMBOL                                  | CONDITIONS                                       |                                       | MIN    | TYP    | MAX           | UNITS           |
|--|---|--|---------------------------------------|--------|--------|---------------|-----------------|
| Output Voltage                         | $V_{OUT}$                               | $T_A = +25^\circ C$                              | MAX6033A                              | 2.9988 | 3.0000 | 3.0012        | V               |
|  |   |  | MAX6033B                              | 2.9940 | 3.0000 | 3.0060        |                 |
|  |   |  | MAX6033C                              | 2.9970 | 3.0000 | 3.0030        |                 |
| Output-Voltage Accuracy                |   | $T_A = +25^\circ C$                              | MAX6033A                              | -0.04  |        | +0.04         | %               |
|  |   |  | MAX6033B                              | -0.2   |        | +0.2          |                 |
|  |   |  | MAX6033C                              | -0.1   |        | +0.1          |                 |
| Output-Voltage Temperature Coefficient | $TCV_{OUT}$                             | MAX6033A   | $T_A = -40^\circ C$ to $+85^\circ C$  |        | 1.5    | 7             | ppm/ $^\circ C$ |
|  |   |  | $T_A = -40^\circ C$ to $+125^\circ C$ |        | 2.5    | 10            |                 |
|  |   | MAX6033B   | $T_A = -40^\circ C$ to $+85^\circ C$  |        | 3      | 10            |                 |
|  |   |  | $T_A = -40^\circ C$ to $+125^\circ C$ |        | 7      | 15            |                 |
|  |   | MAX6033C   | $T_A = -40^\circ C$ to $+85^\circ C$  |        | 6      | 20            |                 |
|  |   |  | $T_A = -40^\circ C$ to $+125^\circ C$ |        | 10     | 40            |                 |
| Input Voltage Range                    | $V_{IN}$                                | Inferred from line regulation specification      |                                       | 3.2    |        | 12.6          | V               |
| Line Regulation                        | $\frac{\Delta V_{OUT}}{\Delta V_{IN}}$  | $3.2V \leq V_{IN} \leq 12.6V$                    | $T_A = +25^\circ C$                   |        | 4      | 30            | $\mu V/V$       |
|  |   |  | $T_A = -40^\circ C$ to $+125^\circ C$ |        |        | 60            |                 |
| Load Regulation                        | $\frac{\Delta V_{OUT}}{\Delta I_{OUT}}$ | $-100\mu A \leq I_{OUT} \leq 15mA$               | $T_A = +25^\circ C$                   |        | 0.002  | 0.06          | mV/mA           |
|  |   |  | $T_A = -40^\circ C$ to $+125^\circ C$ |        |        | 0.12          |                 |
| Dropout Voltage (Note 2)               | $V_{DO}$                                | $\Delta V_{OUT} = 0.1\%$                         | $I_{OUT} = 1mA$                       |        | 0.02   | 0.2           | V               |
|  |   |  | $I_{OUT} = 10mA$                      |        | 0.2    | 0.4           |                 |
|  |   |  |                                       |        |        |               |                 |
| Quiescent Supply Current               | $I_{IN}$                                | $T_A = +25^\circ C$                              |                                       | 40     | 60     | $\mu A$       |                 |
|  |   | $T_A = -40^\circ C$ to $+85^\circ C$             |                                       |        | 75     |               |                 |
|  |   | $T_A = -40^\circ C$ to $+125^\circ C$            |                                       |        | 85     |               |                 |
| Output Short-Circuit Current           | $I_{SC}$                                | $V_{OUT} = 0V$                                   |                                       | 90     |        | mA            |                 |
|  |   | $V_{OUT} = V_{IN}$                               |                                       | -2     |        |               |                 |
| Output-Voltage Noise                   | $e_n$                                   | $0.1Hz \leq f \leq 10Hz$                         |                                       | 24     |        | $\mu V_{P-P}$ |                 |
|  |   | $10Hz \leq f \leq 1kHz$                          |                                       | 15     |        | $\mu V_{RMS}$ |                 |
| Turn-On Settling Time                  | $t_{ON}$                                | $V_{OUT}$ settles to $\pm 0.01\%$ of final value |                                       | 600    |        | $\mu s$       |                 |
| Temperature Hysteresis                 |   | (Note 3)   |                                       | 150    |        | ppm           |                 |
| Long-Term Stability                    |   | $\Delta t = 1000hr$                              |                                       | 40     |        | ppm           |                 |

### ELECTRICAL CHARACTERISTICS— $V_{OUT} = 4.096V$

( $V_{IN} = 5V$ ,  $C_{OUT} = 0.1\mu F$ ,  $I_{OUT} = 0A$ ,  $T_A = T_{MIN}$  to  $T_{MAX}$ , unless otherwise specified. Typical values are at  $T_A = +25^\circ C$ .) (Note 1)

| PARAMETER               | SYMBOL    | CONDITIONS          |          | MIN    | TYP    | MAX    | UNITS |
|-------------------------|-----------|---------------------|----------|--------|--------|--------|-------|
| Output Voltage          | $V_{OUT}$ | $T_A = +25^\circ C$ | MAX6033A | 4.0943 | 4.0960 | 4.0977 | V     |
|                         |           |                     | MAX6033B | 4.0878 | 4.0960 | 4.1042 |       |
|                         |           |                     | MAX6033C | 4.0919 | 4.0960 | 4.1001 |       |
| Output-Voltage Accuracy |           | $T_A = +25^\circ C$ | MAX6033A | -0.04  |        | +0.04  | %     |
|                         |           |                     | MAX6033B | -0.2   |        | +0.2   |       |
|                         |           |                     | MAX6033C | -0.1   |        | +0.1   |       |

# MAX6033

## Ultra-High-Precision SOT23 Series Voltage Reference

### ELECTRICAL CHARACTERISTICS— $V_{OUT} = 4.096V$ (continued)

( $V_{IN} = 5V$ ,  $C_{OUT} = 0.1\mu F$ ,  $I_{OUT} = 0A$ ,  $T_A = T_{MIN}$  to  $T_{MAX}$ , unless otherwise specified. Typical values are at  $T_A = +25^\circ C$ .) (Note 1)

| PARAMETER                              | SYMBOL                          | CONDITIONS                                       | MIN                                   | TYP   | MAX  | UNITS           |
|--|---------------------------------|--|---------------------------------------|-------|------|-----------------|
| Output-Voltage Temperature Coefficient | TCV <sub>OUT</sub>              | MAX6033A   | $T_A = -40^\circ C$ to $+85^\circ C$  | 1.5   | 7    | ppm/ $^\circ C$ |
|  |                                 |  | $T_A = -40^\circ C$ to $+125^\circ C$ | 2.5   | 10   |                 |
|  |                                 | MAX6033B   | $T_A = -40^\circ C$ to $+85^\circ C$  | 3     | 10   |                 |
|  |                                 |  | $T_A = -40^\circ C$ to $+125^\circ C$ | 7     | 15   |                 |
|  |                                 | MAX6033C   | $T_A = -40^\circ C$ to $+85^\circ C$  | 6     | 20   |                 |
|  |                                 |  | $T_A = -40^\circ C$ to $+125^\circ C$ | 10    | 40   |                 |
| Input-Voltage Range                    | $V_{IN}$                        | Inferred from line regulation specification      | 4.3                                   |       | 12.6 | V               |
| Line Regulation                        | $\Delta V_{OUT}/\Delta V_{IN}$  | $4.3V \leq V_{IN} \leq 12.6V$                    | $T_A = +25^\circ C$                   | 6     | 30   | $\mu V/V$       |
|  |                                 |  | $T_A = -40^\circ C$ to $+125^\circ C$ |       | 60   |                 |
| Load Regulation                        | $\Delta V_{OUT}/\Delta I_{OUT}$ | $-100\mu A \leq I_{OUT} \leq 15mA$               | $T_A = +25^\circ C$                   | 0.002 | 0.08 | mV/mA           |
|  |                                 |  | $T_A = -40^\circ C$ to $+125^\circ C$ |       | 0.15 |                 |
| Dropout Voltage (Note 2)               | $V_{DO}$                        | $\Delta V_{OUT} = 0.1\%$                         | $I_{OUT} = 1mA$                       | 0.02  | 0.2  | V               |
|  |                                 |  | $I_{OUT} = 10mA$                      | 0.2   | 0.4  |                 |
| Quiescent Supply Current               | $I_{IN}$                        | $T_A = +25^\circ C$                              |                                       | 40    | 60   | $\mu A$         |
|  |                                 | $T_A = -40^\circ C$ to $+85^\circ C$             |                                       |       | 75   |                 |
|  |                                 | $T_A = -40^\circ C$ to $+125^\circ C$            |                                       |       | 85   |                 |
| Output Short-Circuit Current           | $I_{SC}$                        | $V_{OUT} = 0V$                                   |                                       | 90    |      | mA              |
|  |                                 | $V_{OUT} = V_{IN}$                               |                                       | -2    |      |                 |
| Output-Voltage Noise                   | $e_n$                           | $0.1Hz \leq f \leq 10Hz$                         |                                       | 32    |      | $\mu V_{P-P}$   |
|  |                                 | $10Hz \leq f \leq 1kHz$                          |                                       | 22    |      | $\mu V_{RMS}$   |
| Turn-On Settling Time                  | $t_{ON}$                        | $V_{OUT}$ settles to $\pm 0.01\%$ of final value |                                       | 800   |      | $\mu s$         |
| Temperature Hysteresis                 |                                 | (Note 3)   |                                       | 150   |      | ppm             |
| Long-Term Stability                    |                                 | $\Delta t = 1000hr$                              |                                       | 40    |      | ppm             |

### ELECTRICAL CHARACTERISTICS— $V_{OUT} = 5.000V$

( $V_{IN} = 5.5V$ ,  $C_{OUT} = 0.1\mu F$ ,  $I_{OUT} = 0A$ ,  $T_A = T_{MIN}$  to  $T_{MAX}$ , unless otherwise specified. Typical values are at  $T_A = +25^\circ C$ .) (Note 1)

| PARAMETER                              | SYMBOL             | CONDITIONS                                  | MIN                                   | TYP    | MAX   | UNITS           |   |
|--|--------------------|---|---------------------------------------|--------|-------|-----------------|---|
| Output Voltage                         | $V_{OUT}$          | $T_A = +25^\circ C$                         | MAX6033A                              | 4.9980 | 5.000 | 5.0020          | V |
|  |                    |   | MAX6033B                              | 4.9900 | 5.000 | 5.0100          |   |
|  |                    |   | MAX6033C                              | 4.9950 | 5.000 | 5.0050          |   |
| Output-Voltage Accuracy                |                    | $T_A = +25^\circ C$                         | MAX6033A                              | -0.04  |       | +0.04           | % |
|  |                    |   | MAX6033B                              | -0.2   |       | +0.2            |   |
|  |                    |   | MAX6033C                              | -0.1   |       | +0.1            |   |
| Output-Voltage Temperature Coefficient | TCV <sub>OUT</sub> | MAX6033A                                    | $T_A = -40^\circ C$ to $+85^\circ C$  | 1.5    | 7     | ppm/ $^\circ C$ |   |
|  |                    |   | $T_A = -40^\circ C$ to $+125^\circ C$ | 2.5    | 10    |                 |   |
|  |                    | MAX6033B                                    | $T_A = -40^\circ C$ to $+85^\circ C$  | 3      | 10    |                 |   |
|  |                    |   | $T_A = -40^\circ C$ to $+125^\circ C$ | 7      | 15    |                 |   |
|  |                    | MAX6033C                                    | $T_A = -40^\circ C$ to $+85^\circ C$  | 6      | 20    |                 |   |
|  |                    |   | $T_A = -40^\circ C$ to $+125^\circ C$ | 10     | 40    |                 |   |
| Input Voltage Range                    | $V_{IN}$           | Inferred from line regulation specification | 5.2                                   |        | 12.6  | V               |   |

# MAX6033

## Ultra-High-Precision SOT23 Series Voltage Reference

### ELECTRICAL CHARACTERISTICS— $V_{OUT} = 5.000V$ (continued)

( $V_{IN} = 5.5V$ ,  $C_{OUT} = 0.1\mu F$ ,  $I_{OUT} = 0A$ ,  $T_A = T_{MIN}$  to  $T_{MAX}$ , unless otherwise specified. Typical values are at  $T_A = +25^\circ C$ .) (Note 1)

| PARAMETER                    | SYMBOL                                  | CONDITIONS                                       | MIN                                   | TYP   | MAX | UNITS         |
|------------------------------|---|--|---------------------------------------|-------|-----|---------------|
| Line Regulation              | $\frac{\Delta V_{OUT}}{\Delta V_{IN}}$  | $5.2V \leq V_{IN} \leq 12.6V$                    | $T_A = +25^\circ C$                   | 7     | 50  | $\mu V/V$     |
|                              |   |  | $T_A = -40^\circ C$ to $+125^\circ C$ |       | 100 |               |
| Load Regulation              | $\frac{\Delta V_{OUT}}{\Delta I_{OUT}}$ | $-100\mu A \leq I_{OUT} \leq 15mA$               | $T_A = +25^\circ C$                   | 0.003 | 0.1 | mV/mA         |
|                              |   |  | $T_A = -40^\circ C$ to $+125^\circ C$ |       | 0.2 |               |
| Dropout Voltage (Note 2)     | $V_{DO}$                                | $\Delta V_{OUT} = 0.1\%$                         | $I_{OUT} = 1mA$                       | 0.02  | 0.2 | V             |
|                              |   |  | $I_{OUT} = 10mA$                      | 0.2   | 0.4 |               |
| Quiescent Supply Current     | $I_{IN}$                                | $T_A = +25^\circ C$                              |                                       | 40    | 60  | $\mu A$       |
|                              |   | $T_A = -40^\circ C$ to $+85^\circ C$             |                                       |       | 75  |               |
|                              |   | $T_A = -40^\circ C$ to $+125^\circ C$            |                                       |       | 85  |               |
| Output Short-Circuit Current | $I_{SC}$                                | $V_{OUT} = 0V$                                   |                                       | 90    |     | mA            |
|                              |   | $V_{OUT} = V_{IN}$                               |                                       | -2    |     |               |
| Output-Voltage Noise         | $e_n$                                   | $0.1Hz \leq f \leq 10Hz$                         |                                       | 40    |     | $\mu V_{P-P}$ |
|                              |   | $10Hz \leq f \leq 1kHz$                          |                                       | 26    |     | $\mu V_{RMS}$ |
| Turn-On Settling Time        | $t_{ON}$                                | $V_{OUT}$ settles to $\pm 0.01\%$ of final value |                                       | 1000  |     | $\mu s$       |
| Temperature Hysteresis       |   | (Note 3)   |                                       | 150   |     | ppm           |
| Long-Term Stability          |   | $\Delta t = 1000hr$                              |                                       | 40    |     | ppm           |

**Note 1:** MAX6033 is 100% production tested at  $T_A = +25^\circ C$  and is guaranteed by design for  $T_A = T_{MIN}$  to  $T_{MAX}$  as specified.

**Note 2:** Dropout Voltage is the minimum input voltage at which  $V_{OUT}$  changes  $\leq 0.1\%$  from  $V_{OUT}$  at  $V_{IN} = 5V$  ( $V_{IN} = 5.5V$  for  $V_{OUT} = 5V$ ).

**Note 3:** Temperature Hysteresis is defined as the change in  $+25^\circ C$  output voltage before and after cycling the device from  $T_{MAX}$  to  $T_{MIN}$ .

### Typical Operating Characteristics

( $V_{IN} = 5V$ ,  $C_{OUT} = 0.1\mu F$ ,  $I_{OUT} = 0A$ ,  $T_A = +25^\circ C$ , unless otherwise specified.) (Note 4)

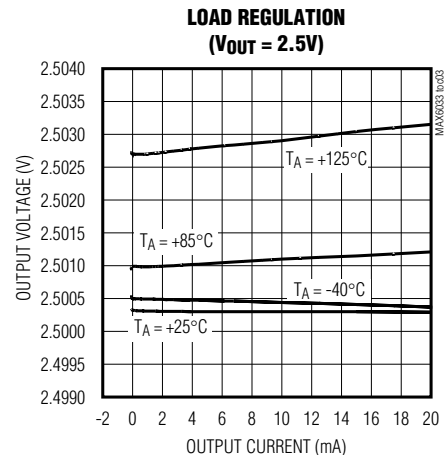
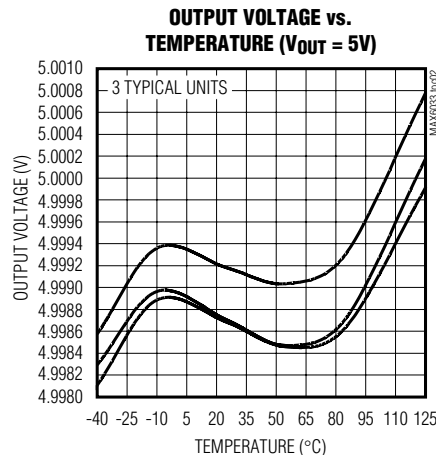
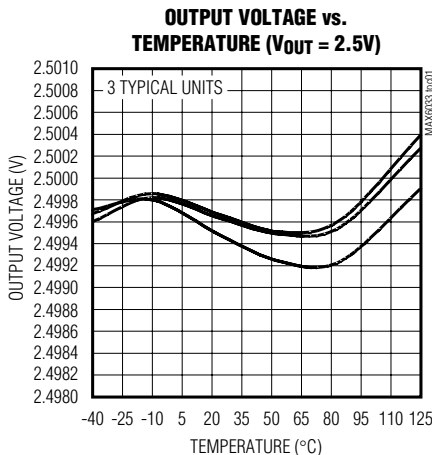

# MAX6033

## Ultra-High-Precision SOT23 Series Voltage Reference

### Typical Operating Characteristics (continued)

( $V_{IN} = 5V$ ,  $C_{OUT} = 0.1\mu F$ ,  $I_{OUT} = 0A$ ,  $T_A = +25^\circ C$ , unless otherwise specified.) (Note 4)

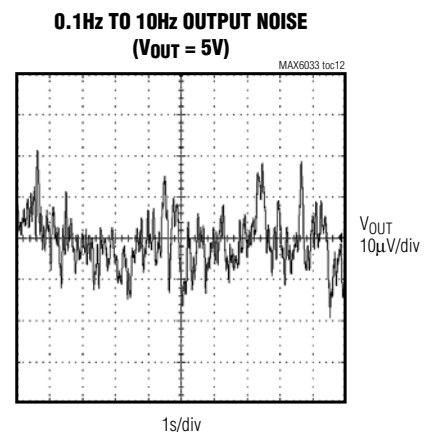
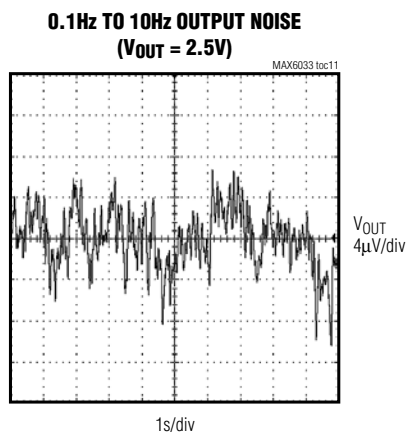
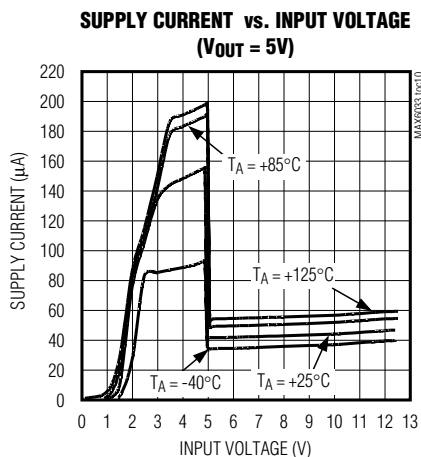
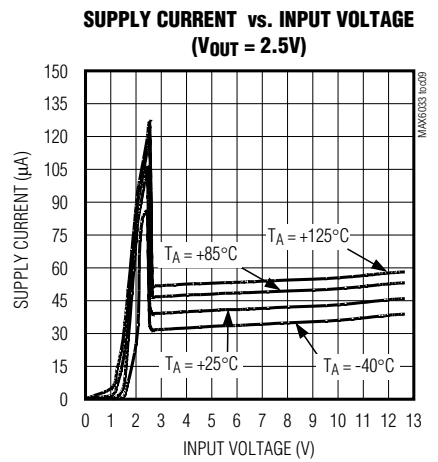
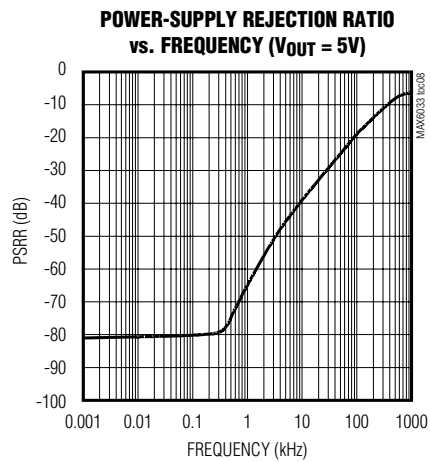
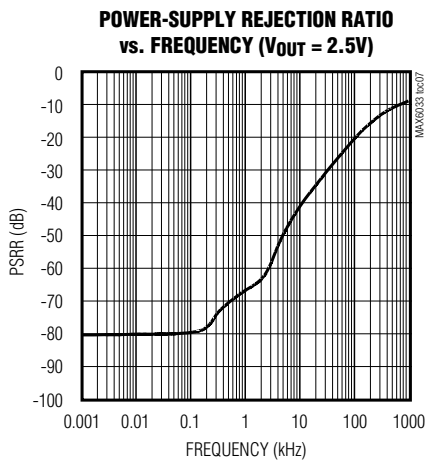
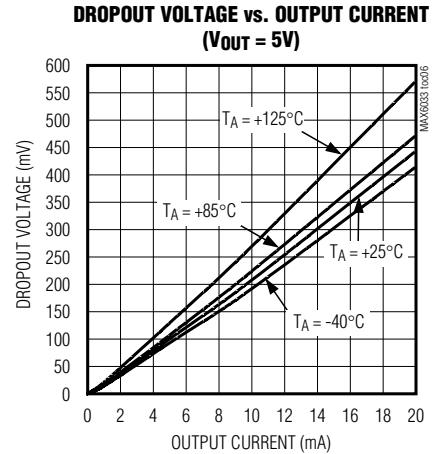
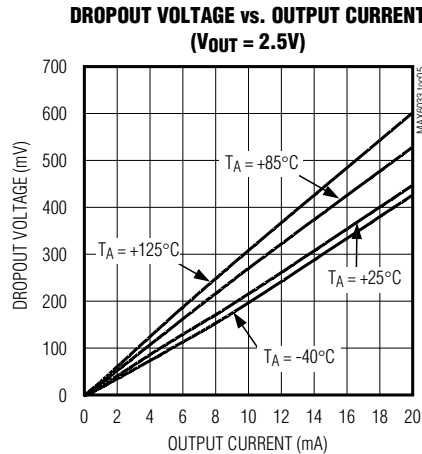
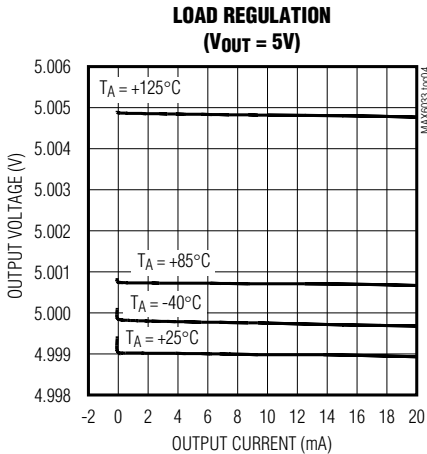

# MAX6033

## Ultra-High-Precision SOT23 Series Voltage Reference

### Typical Operating Characteristics (continued)

( $V_{IN} = 5V$ ,  $C_{OUT} = 0.1\mu F$ ,  $I_{OUT} = 0A$ ,  $T_A = +25^\circ C$ , unless otherwise specified.) (Note 4)

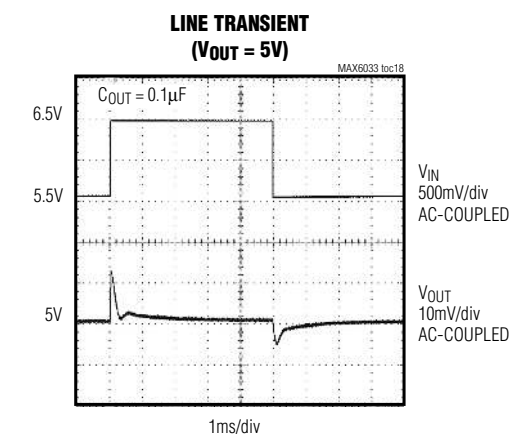
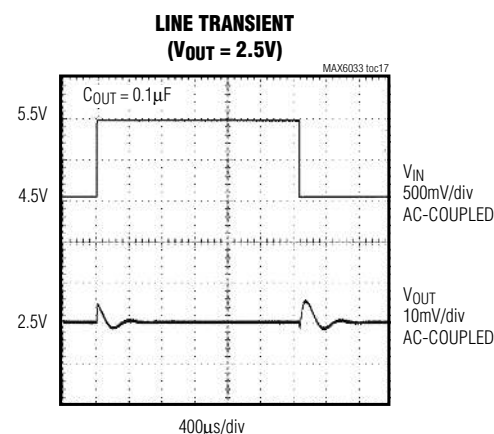
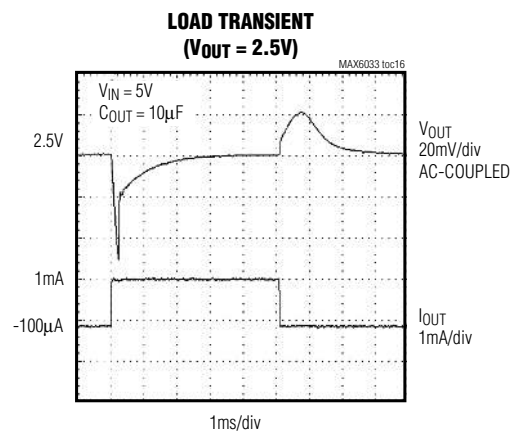
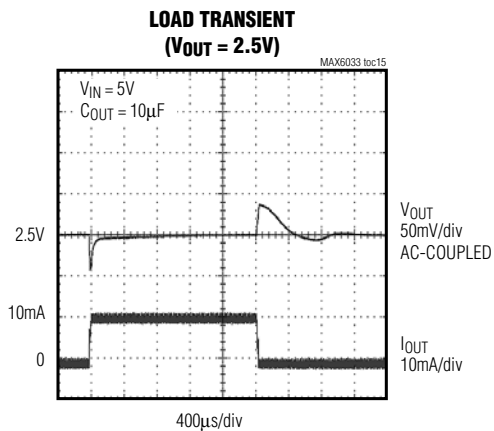
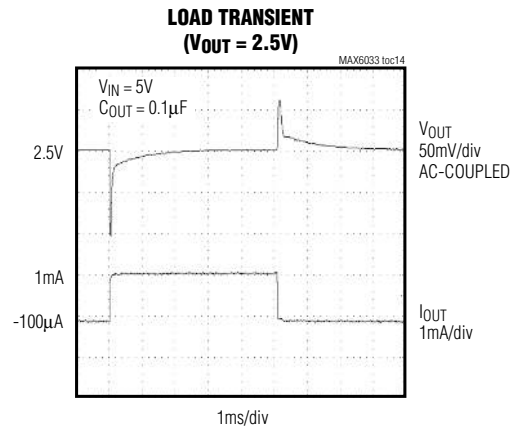
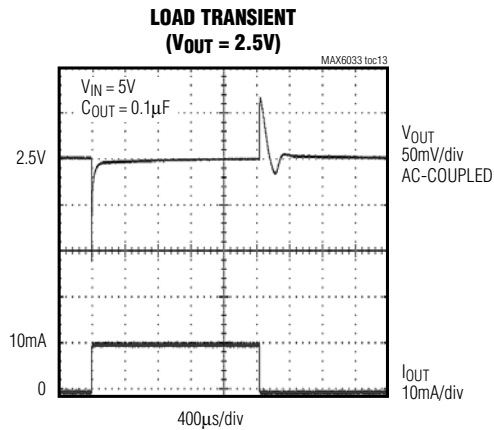

# MAX6033

## Ultra-High-Precision SOT23 Series Voltage Reference

### Typical Operating Characteristics (continued)

( $V_{IN} = 5V$ ,  $C_{OUT} = 0.1\mu F$ ,  $I_{OUT} = 0A$ ,  $T_A = +25^\circ C$ , unless otherwise specified.) (Note 4)

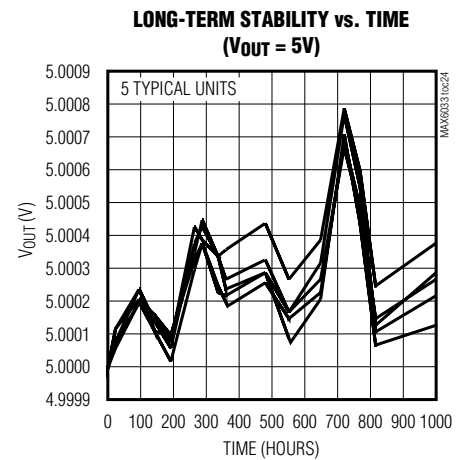
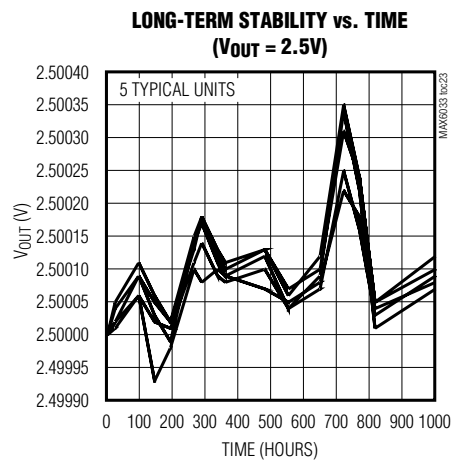
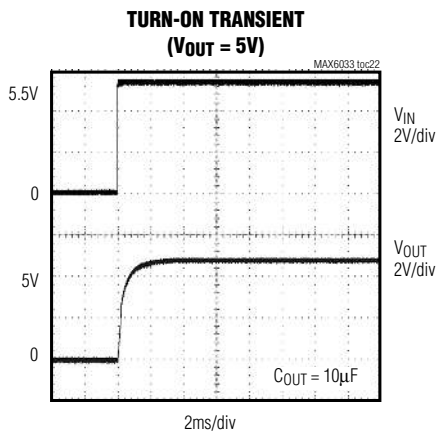
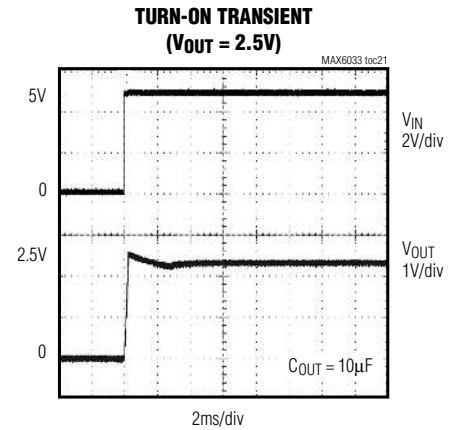
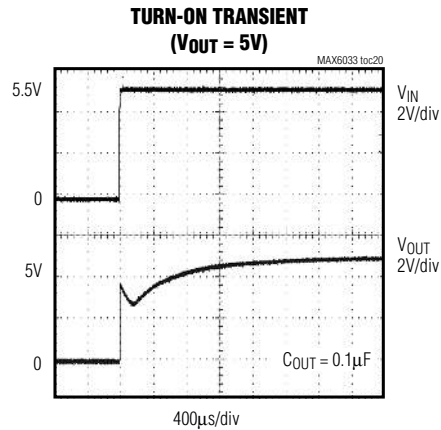
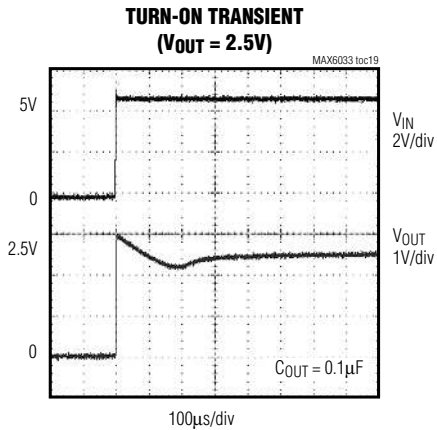

**Note 4:** Many of the MAX6033 *Typical Operating Characteristics* are similar. The extremes of these characteristics are found in the MAX6033 (2.5V output) and the MAX6033 (5V output). The *Typical Operating Characteristics* of the remainder of the MAX6033 family typically lie between these two extremes and can be estimated based on their output voltages.



# MAX6033

## Ultra-High-Precision SOT23 Series Voltage Reference

### Pin Description

| PIN  | NAME | FUNCTION  |
|------|------|---|
| 1, 3 | I.C. | Internally Connected. Do not connect externally.  |
| 2    | GND  | Ground  |
| 4    | IN   | Positive Power-Supply Input   |
| 5    | OUTF | Voltage Reference Force Output. Short OUTF to OUTS as close to the device as possible. Bypass OUTF with 0.1 $\mu$ F (min) capacitor to GND. |
| 6    | OUTS | Voltage Reference Sense   |

### Applications Information

#### Bypassing/Load Capacitance

For the best line-transient performance, decouple the input with a 0.1 $\mu$ F ceramic capacitor as shown in the *Typical Operating Circuit*. Place the capacitor as close to IN as possible. When transient performance is less important, no capacitor is necessary.

The MAX6033 family requires a minimum output capacitance of 0.1 $\mu$ F for stability and is stable with capacitive loads (including the bypass capacitance) of up to 100 $\mu$ F. In applications where the load or the supply can experience step changes, a larger output capacitor reduces the amount of overshoot (undershoot) and improves the circuit's transient response. Place output capacitors as close to the device as possible.

#### Supply Current

The quiescent supply current of the MAX6033 series reference is typically 40 $\mu$ A and is virtually independent of the supply voltage. In the MAX6033 family, the load current is drawn from the input only when required, so supply current is not wasted and efficiency is maximized at all input voltages. This improved efficiency reduces power dissipation and extends battery life.

When the supply voltage is below the minimum-specified input voltage (as during turn-on), the devices can draw up to 150 $\mu$ A beyond the nominal supply current. The input voltage source must be capable of providing this current to ensure reliable turn-on.

#### Output-Voltage Hysteresis

Output voltage hysteresis is the change in the output voltage at  $T_A = +25^\circ\text{C}$  before and after the device is cycled over its entire operating temperature range. Hysteresis is caused by differential package stress appearing across the bandgap core transistors. The typical temperature hysteresis value is 150ppm.

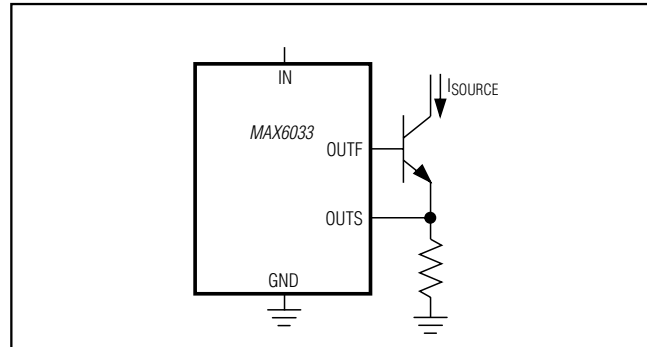

Figure 1. Precision Current Source

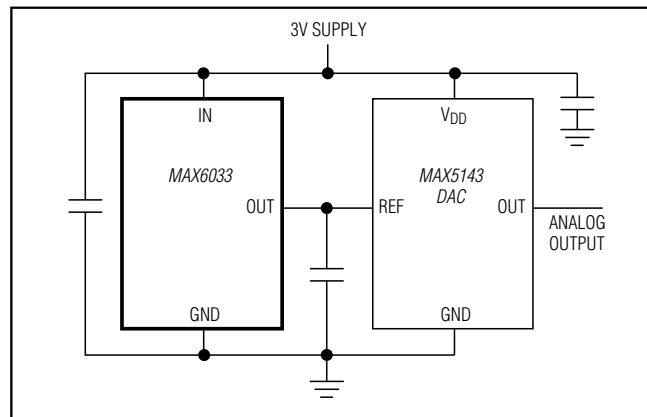

Figure 2. 14-Bit High-Resolution DAC and Positive Reference from a Single 3V Supply

#### Turn-On Time

These devices typically turn on and settle to within 0.01% of their final value in  $>1\mu\text{s}$ . The turn-on time can increase up to 2ms with the device operating at the minimum dropout voltage and the maximum load.

#### Precision Current Source

Figure 1 shows a typical circuit providing a precision current source. The OUTF output provides the bias current for the bipolar transistor. OUTF senses the voltage across the resistor and adjusts the current sourced by OUTF accordingly.

#### High-Resolution DAC and Reference from Single Supply

Figure 2 shows a typical circuit providing both the power supply and reference for a high-resolution DAC. A MAX6033 with 2.5V output provides the reference voltage for the DAC.

# MAX6033

## Ultra-High-Precision SOT23 Series Voltage Reference

### Ordering Information/Selector Guide (continued)

| PART               | OUTPUT VOLTAGE (V) | TEMP COEFF (ppm/°C) | INITIAL ACCURACY (%) | TOP MARK |
|--------------------|--------------------|---------------------|----------------------|----------|
| MAX6033CAUT30-T    | 3.000              | 40                  | 0.10                 | AAXI     |
| MAX6033CAUT30#TG16 | 3.000              | 40                  | 0.10                 | #ACNH    |
| MAX6033AAUT41-T    | 4.096              | 10                  | 0.04                 | ABDH     |
| MAX6033AAUT41#TG16 | 4.096              | 10                  | 0.04                 | #ACNI    |
| MAX6033BAUT41-T    | 4.096              | 15                  | 0.20                 | AAXN     |
| MAX6033BAUT41#TG16 | 4.096              | 15                  | 0.20                 | #ACLG    |
| MAX6033CAUT41-T    | 4.096              | 40                  | 0.10                 | AAXJ     |
| MAX6033CAUT41#TG16 | 4.096              | 40                  | 0.10                 | #ACNJ    |
| MAX6033AAUT50-T    | 5.000              | 10                  | 0.04                 | ABDI     |
| MAX6033AAUT50#TG16 | 5.000              | 10                  | 0.04                 | #ACNK    |
| MAX6033BAUT50-T    | 5.000              | 15                  | 0.20                 | AAXO     |
| MAX6033BAUT50#TG16 | 5.000              | 15                  | 0.20                 | #ACNL    |
| MAX6033CAUT50-T    | 5.000              | 40                  | 0.10                 | AAXK     |
| MAX6033CAUT50#TG16 | 5.000              | 40                  | 0.10                 | #ACNM    |

#Denotes a RoHS-compliant device that may include lead(Pb) that is exempt under the RoHS requirements.

T = Tape and reel.

### Typical Operating Circuit

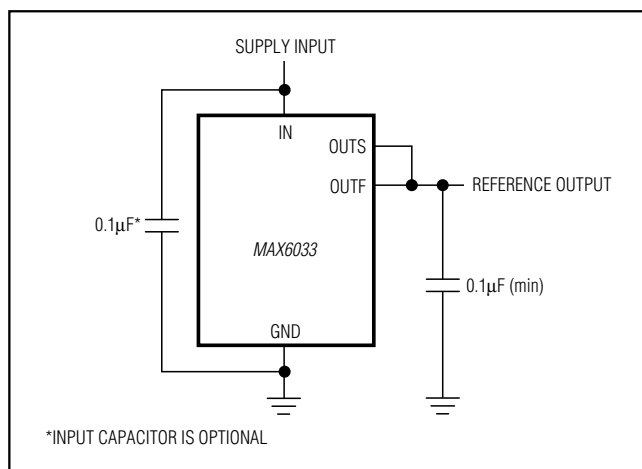

### Chip Information

PROCESS: BiCMOS

### Package Information

For the latest package outline information and land patterns (footprints), go to [www.maximintegrated.com/packages](http://www.maximintegrated.com/packages). Note that a "+", "#", or "-" in the package code indicates RoHS status only. Package drawings may show a different suffix character, but the drawing pertains to the package regardless of RoHS status.

| PACKAGE TYPE | PACKAGE CODE | OUTLINE NO.             | LAND PATTERN NO.        |
|--------------|--------------|-------------------------|-------------------------|
| SOT23-6      | U6F-6        | <a href="#">21-0058</a> | <a href="#">90-0175</a> |
| RoHS SOT23-6 | UGFH-6       | —                       | —                       |

# MAX6033

## Ultra-High-Precision SOT23 Series Voltage Reference

### Revision History

| REVISION NUMBER | REVISION DATE | DESCRIPTION   | PAGES CHANGED |
|-----------------|---------------|---|---------------|
| 2               | 6/03          | Various changes   | —             |
| 3               | 3/12          | Replaced <i>Ordering Information</i> table/ <i>Selector Guide</i> , updated packaging information | 1, 10         |



Maxim Integrated cannot assume responsibility for use of any circuitry other than circuitry entirely embodied in a Maxim Integrated product. No circuit patent licenses are implied. Maxim Integrated reserves the right to change the circuitry and specifications without notice at any time. The parametric values (min and max limits) shown in the Electrical Characteristics table are guaranteed. Other parametric values quoted in this data sheet are provided for guidance.

**Maxim Integrated 160 Rio Robles, San Jose, CA 95134 USA 1-408-601-1000**

11