

MC14049B, MC14050B

Hex Buffer

The MC14049B Hex Inverter/Buffer and MC14050B Noninverting Hex Buffer are constructed with MOS P-Channel and N-Channel enhancement mode devices in a single monolithic structure. These complementary MOS devices find primary use where low power dissipation and/or high noise immunity is desired. These devices provide logic level conversion using only one supply voltage, V_{DD} .

The input-signal high level (V_{IH}) can exceed the V_{DD} supply voltage for logic level conversions. Two TTL/DTL loads can be driven when the devices are used as a CMOS-to-TTL/DTL converter ($V_{DD} = 5.0\text{ V}$, $V_{OL} \leq 0.4\text{ V}$, $I_{OL} \geq 3.2\text{ mA}$).

Note that pins 13 and 16 are not connected internally on these devices; consequently connections to these terminals will not affect circuit operation.

- High Source and Sink Currents
- High-to-Low Level Converter
- Supply Voltage Range = 3.0 V to 18 V
- V_{IN} can exceed V_{DD}
- Meets JEDEC B Specifications
- Improved ESD Protection On All Inputs

MAXIMUM RATINGS (Voltages Referenced to V_{SS}) (Note 2.)

Symbol	Parameter	Value	Unit
V_{DD}	DC Supply Voltage Range	-0.5 to +18.0	V
V_{in}	Input Voltage Range (DC or Transient)	-0.5 to +18.0	V
V_{out}	Output Voltage Range (DC or Transient)	-0.5 to $V_{DD} + 0.5$	V
I_{in}	Input Current (DC or Transient) per Pin	± 10	mA
I_{out}	Output Current (DC or Transient) per Pin	± 45	mA
P_D	Power Dissipation, per Package (Note 3.) (Plastic) (SOIC)	825 740	mW
T_A	Ambient Temperature Range	-55 to +125	$^{\circ}\text{C}$
T_{stg}	Storage Temperature Range	-65 to +150	$^{\circ}\text{C}$
T_L	Lead Temperature (8-Second Soldering)	260	$^{\circ}\text{C}$

2. Maximum Ratings are those values beyond which damage to the device may occur.

3. Temperature Derating: See Figure 3.

This device contains protection circuitry to protect the inputs against damage due to high static voltages or electric fields referenced to the V_{SS} pin only. Extra precautions must be taken to avoid applications of any voltage higher than the maximum rated voltages to this high-impedance circuit. For proper operation, the ranges $V_{SS} \leq V_{in} \leq 18\text{ V}$ and $V_{SS} \leq V_{out} \leq V_{DD}$ are recommended.

Unused inputs must always be tied to an appropriate logic voltage level (e.g., either V_{SS} or V_{DD}). Unused outputs must be left open.



ON Semiconductor

<http://onsemi.com>

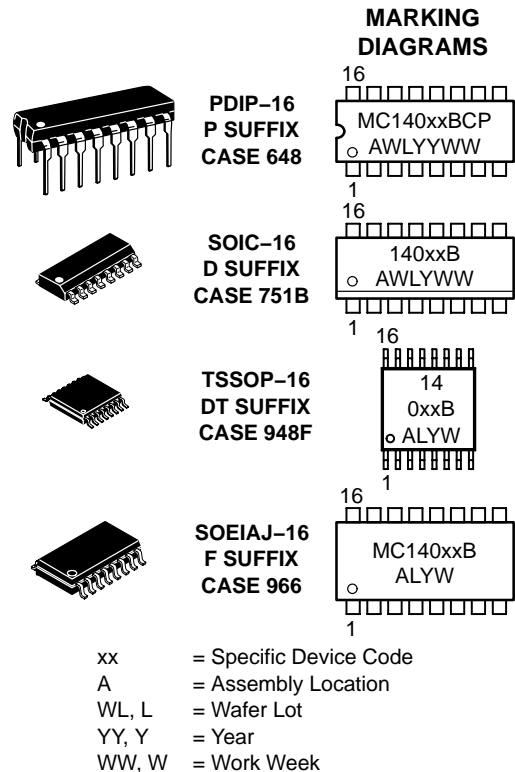

ORDERING INFORMATION

Device	Package	Shipping
MC14049BCP	PDIP-16	2000/Box
MC14049BD	SOIC-16	2400/Box
MC14049BDR2	SOIC-16	2500/Tape & Reel
MC14049BF	SOEIAJ-16	See Note 1.
MC14050BCP	PDIP-16	2000/Box
MC14050BD	SOIC-16	2400/Box
MC14050BDR2	SOIC-16	2500/Tape & Reel
MC14050BDTEL	TSSOP-16	2000/Tape & Reel
MC14050BF	SOEIAJ-16	See Note 1.
MC14050BFEL	SOEIAJ-16	See Note 1.

1. For ordering information on the EIAJ version of the SOIC packages, please contact your local ON Semiconductor representative.

MC14049B, MC14050B

PIN ASSIGNMENT

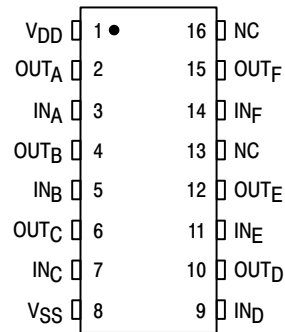

LOGIC DIAGRAM

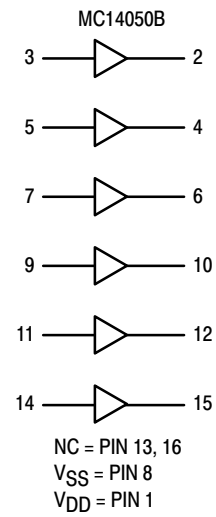
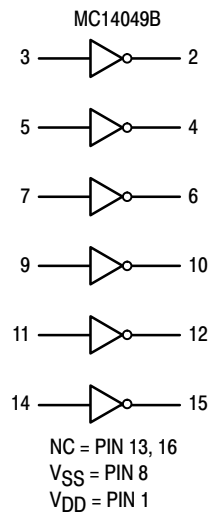

MC14049B, MC14050B

ELECTRICAL CHARACTERISTICS (Voltages Referenced to V_{SS})

Characteristic	Symbol	V _{DD} Vdc	- 55°C		+ 25°C			+ 125°C		Unit
			Min	Max	Min	Typ (4.)	Max	Min	Max	
Output Voltage V _{in} = V _{DD}	"0" Level V _{OL}	5.0	—	0.05	—	0	0.05	—	0.05	Vdc
		10	—	0.05	—	0	0.05	—	0.05	
		15	—	0.05	—	0	0.05	—	0.05	
	V _{in} = 0 "1" Level V _{OH}	5.0	4.95	—	4.95	5.0	—	4.95	—	Vdc
		10	9.95	—	9.95	10	—	9.95	—	
		15	14.95	—	14.95	15	—	14.95	—	
Input Voltage (V _O = 4.5 Vdc) (V _O = 9.0 Vdc) (V _O = 13.5 Vdc)	"0" Level V _{IL}	5.0	—	1.5	—	2.25	1.5	—	1.5	Vdc
		10	—	3.0	—	4.50	3.0	—	3.0	
		15	—	4.0	—	6.75	4.0	—	4.0	
	"1" Level V _{IH}	5.0	3.5	—	3.5	2.75	—	3.5	—	Vdc
		10	7.0	—	7.0	5.50	—	7.0	—	
		15	11	—	11	8.25	—	11	—	
Output Drive Current	Source I _{OH}	(V _{OH} = 2.5 Vdc) 5.0	-1.6	—	-1.25	-2.5	—	-1.0	—	mAdc
		(V _{OH} = 9.5 Vdc) 10	-1.6	—	-1.30	-2.6	—	-1.0	—	
		(V _{OH} = 13.5 Vdc) 15	-4.7	—	-3.75	-10	—	-3.0	—	
	Sink I _{OL}	(V _{OL} = 0.4 Vdc) 5.0	3.75	—	3.2	6.0	—	2.6	—	mAdc
		(V _{OL} = 0.5 Vdc) 10	10	—	8.0	16	—	6.6	—	
		(V _{OL} = 1.5 Vdc) 15	30	—	24	40	—	19	—	
Input Current	I _{in}	15	—	± 0.1	—	± 0.00001	± 0.1	—	± 1.0	μAdc
Input Capacitance (V _{in} = 0)	C _{in}	—	—	—	—	10	20	—	—	pF
Quiescent Current (Per Package)	I _{DD}	5.0	—	1.0	—	0.002	1.0	—	30	μAdc
		10	—	2.0	—	0.004	2.0	—	60	
		15	—	4.0	—	0.006	4.0	—	120	
Total Supply Current (5.) (6.) (Dynamic plus Quiescent, per package) (C _L = 50 pF on all outputs, all buffers switching)	I _T	5.0	I _T = (1.8 μA/kHz) f + I _{DD}							μAdc
		10	I _T = (3.5 μA/kHz) f + I _{DD}							
		15	I _T = (5.3 μA/kHz) f + I _{DD}							

4. Data labelled "Typ" is not to be used for design purposes but is intended as an indication of the IC's potential performance.

5. The formulas given are for the typical characteristics only at + 25°C

6. To calculate total supply current at loads other than 50 pF:

$$I_T(C_L) = I_T(50 \text{ pF}) + (C_L - 50) Vfk$$

Where: I_T is in μA (per Package), C_L in pF, V = (V_{DD} - V_{SS}) in volts, f in kHz is input frequency and k = 0.002.

MC14049B, MC14050B

AC SWITCHING CHARACTERISTICS (7.) ($C_L = 50 \text{ pF}$, $T_A = +25^\circ\text{C}$)

Characteristic	Symbol	V_{DD} Vdc	Min	Typ (8.)	Max	Unit
Output Rise Time $t_{TLH} = (0.7 \text{ ns/pF}) C_L + 65 \text{ ns}$ $t_{TLH} = (0.25 \text{ ns/pF}) C_L + 37.5 \text{ ns}$ $t_{TLH} = (0.2 \text{ ns/pF}) C_L + 30 \text{ ns}$	t_{TLH}	5.0 10 15	— — —	100 50 40	160 80 60	ns
Output Fall Time $t_{THL} = (0.2 \text{ ns/pF}) C_L + 30 \text{ ns}$ $t_{THL} = (0.06 \text{ ns/pF}) C_L + 17 \text{ ns}$ $t_{THL} = (0.04 \text{ ns/pF}) C_L + 13 \text{ ns}$	t_{THL}	5.0 10 15	— — —	40 20 15	60 40 30	ns
Propagation Delay Time $t_{PLH} = (0.33 \text{ ns/pF}) C_L + 63.5 \text{ ns}$ $t_{PLH} = (0.19 \text{ ns/pF}) C_L + 30.5 \text{ ns}$ $t_{PLH} = (0.06 \text{ ns/pF}) C_L + 27 \text{ ns}$	t_{PLH}	5.0 10 15	— — —	80 40 30	140 80 60	ns
Propagation Delay Time $t_{PHL} = (0.2 \text{ ns/pF}) C_L + 30 \text{ ns}$ $t_{PHL} = (0.1 \text{ ns/pF}) C_L + 15 \text{ ns}$ $t_{PHL} = (0.05 \text{ ns/pF}) C_L + 12.5 \text{ ns}$	t_{PHL}	5.0 10 15	— — —	40 20 15	80 40 30	ns

7. The formulas given are for the typical characteristics only at 25°C .

8. Data labeled "Typ" is not to be used for design purposes but is intended as an indication of the IC's potential performance.

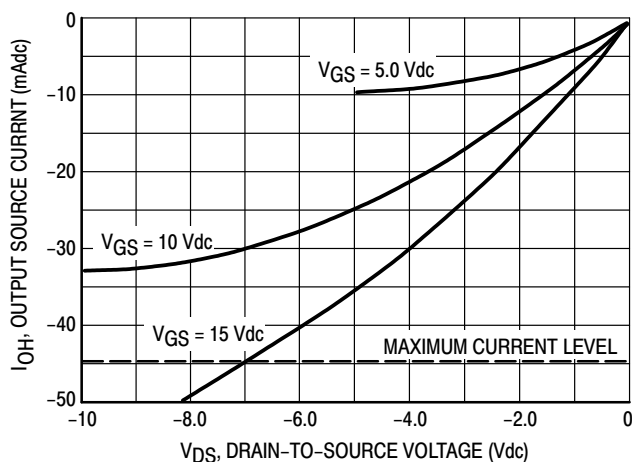
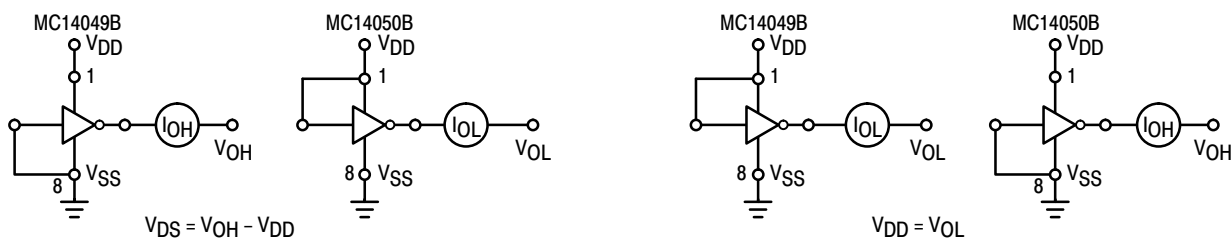

Figure 1. Typical Output Source Characteristics

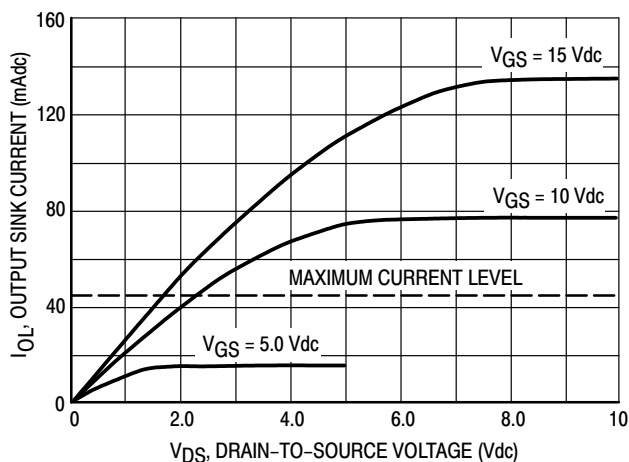

Figure 2. Typical Output Sink Characteristics

MC14049B, MC14050B

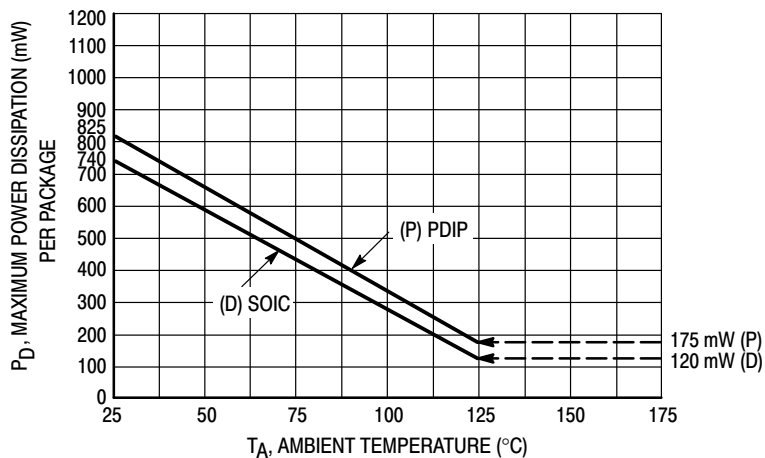

Figure 3. Ambient Temperature Power Derating

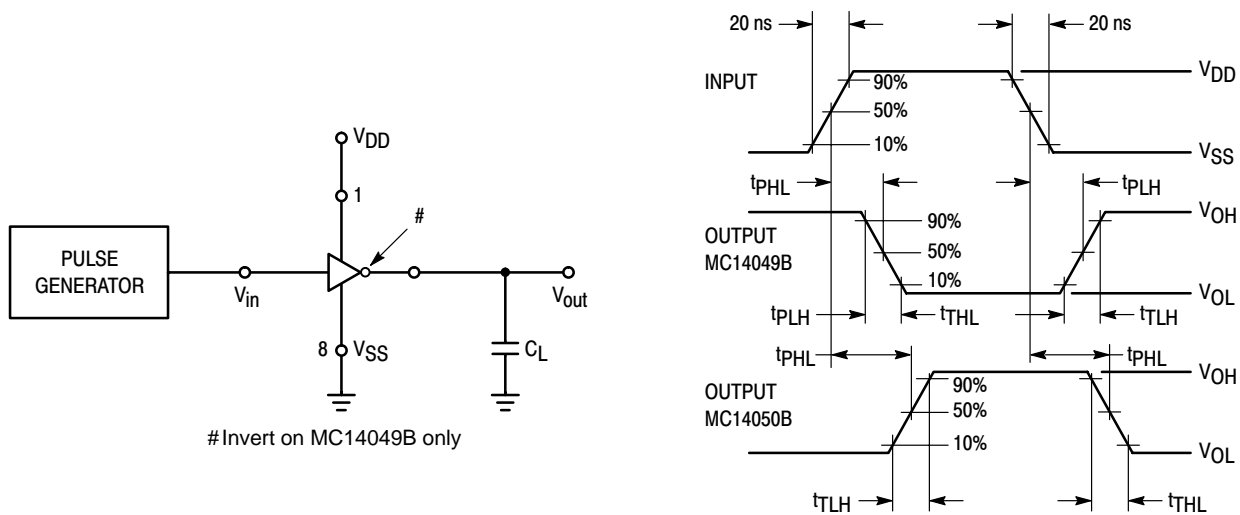

Figure 4. Switching Time Test Circuit and Waveforms