

MODEL: CMS-15116-30-SP | **DESCRIPTION:** SPEAKER**FEATURES**

- micro-speaker
- small footprint
- spring leads

**SPECIFICATIONS**

parameter	conditions/description	min	typ	max	units
input power	maximum power: IEC-60268-5, filter 60s on/120s off, 10 cycles at room temp in 1 cc closed box		0.94	1.30	W
impedance	at 2.0 kHz, 1.0 V	5.1	6.0	6.9	Ω
resonant frequency (Fo)	at 1.0 V at 1.0 V in 1 cc closed box	400 723	500 850	600 978	Hz Hz
frequency response	output SPL ± 10 dB	Fo		20,000	Hz
sound pressure level	at 0.94 W, 0.1 m ave, at 3.0 kHz in 1 cc closed box	91	94	97	dB
distortion	at 1.0 kHz, 0.94 W			10	%
buzz, rattle, etc.	must be normal at sine wave between Fo \sim 20 kHz in 1 cc closed box		2.37		V
polarity	cone will move forward with positive dc current to "+" terminal				
dimensions	15.0 x 11.0 x 3.0				mm
magnet	Nd-Fe-B				
material	PPA				
cone material	mylar				
terminal	spring contact				
weight			1.4		g
operating temperature		-20		60	$^{\circ}$ C
storage temperature		-40		85	$^{\circ}$ C
RoHS	2011/65/EU				

Notes: 1. All specifications measured at 5 \sim 35 $^{\circ}$ C, humidity at 45 \sim 85%, under 86 \sim 106 kPa pressure, unless otherwise noted.

MECHANICAL DRAWING

units: mm
tolerance: ± 0.2 mm

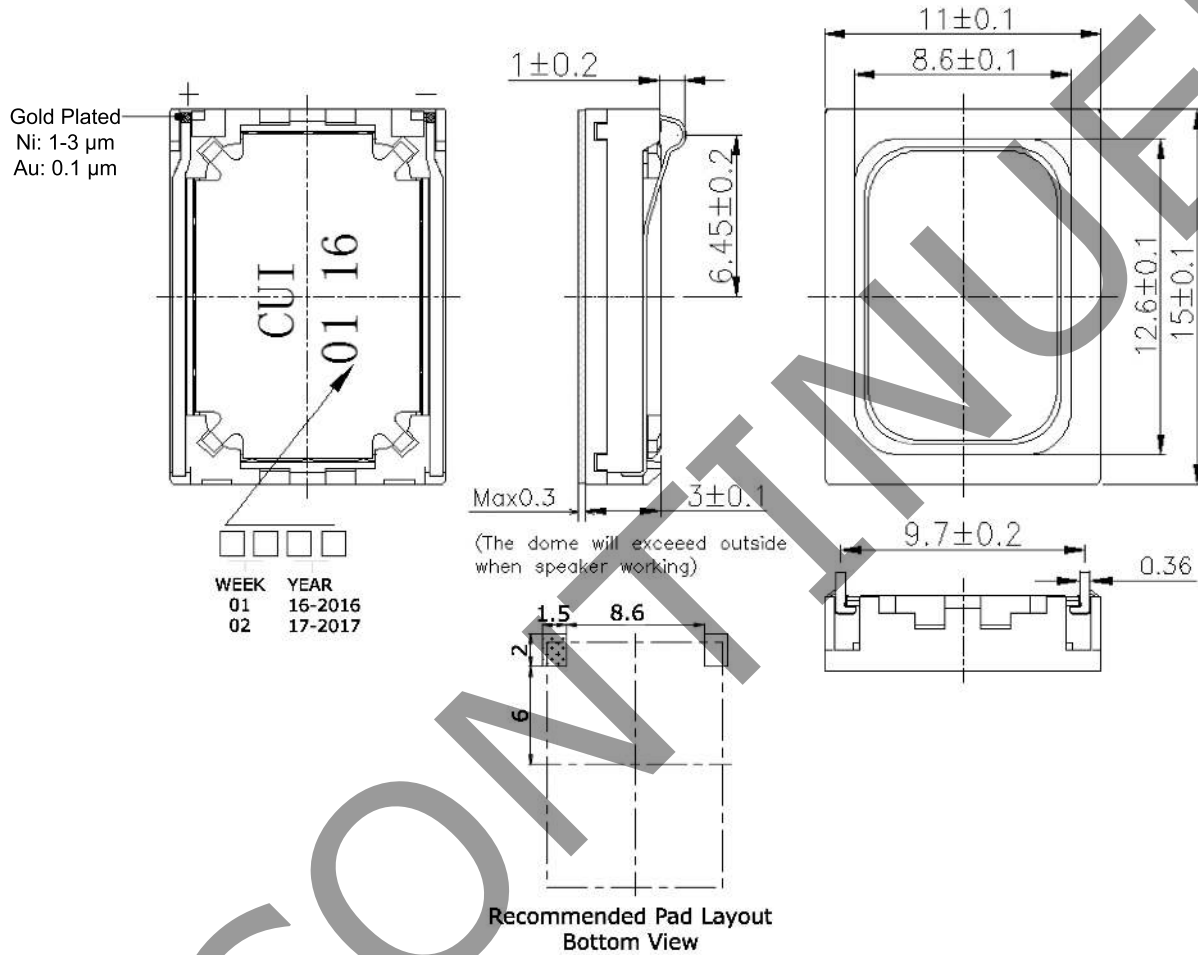

Force Progression Of One Spring Contact



RESPONSE CURVES

Frequency Response Curve

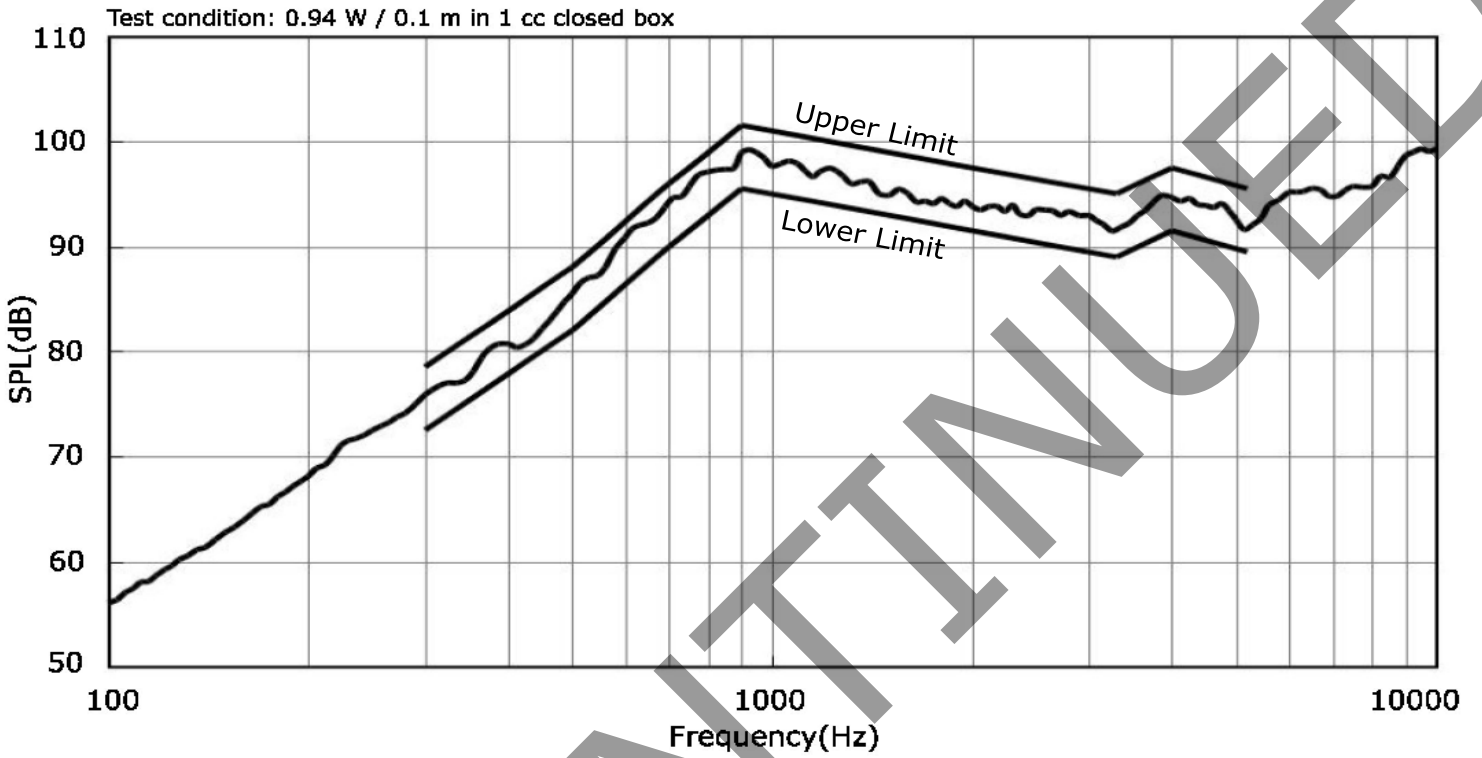

Total Harmonic Distortion Curve

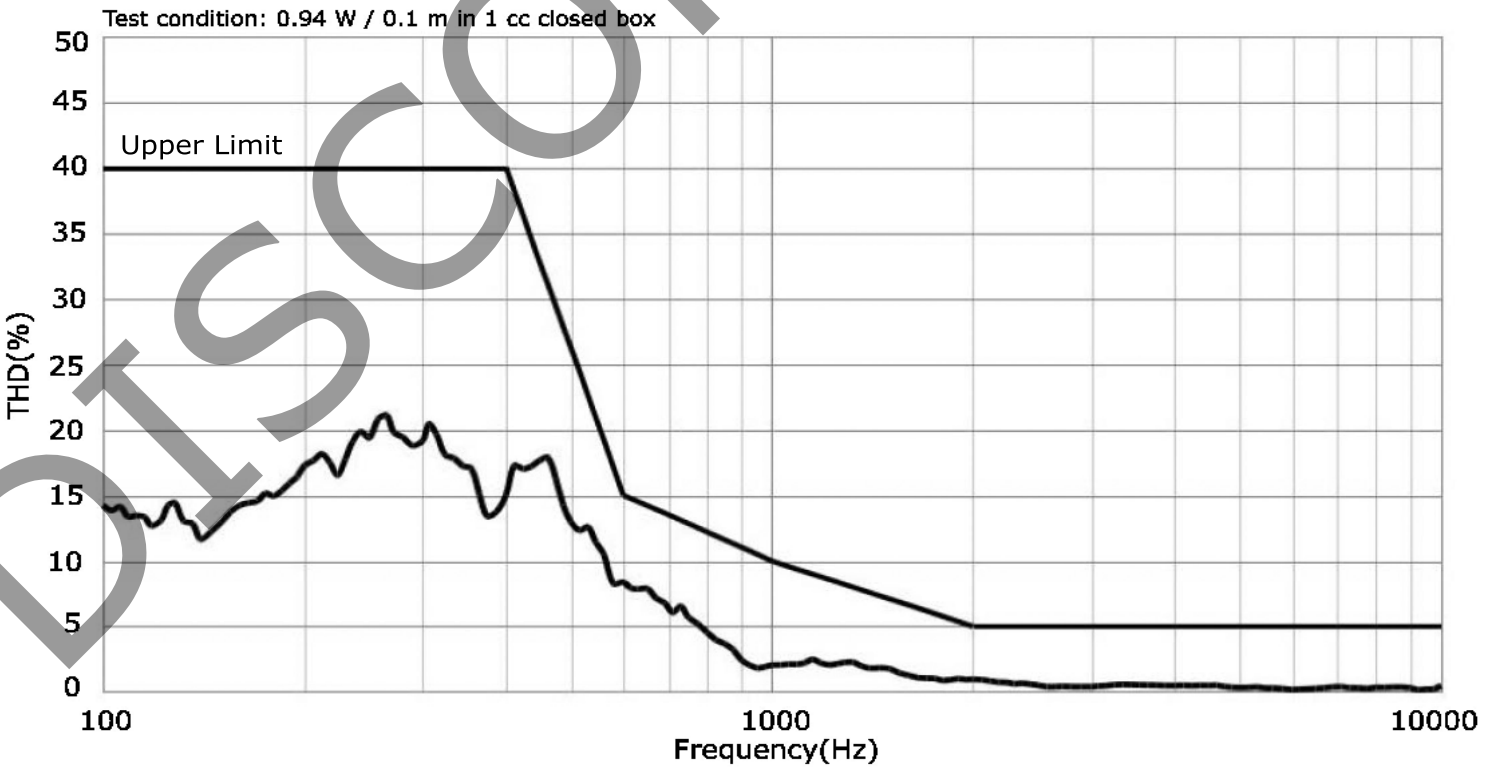

PACKAGING

units: mm

Tray Size: 360 x 225 x 9 mm
Carton Size: 375 x 240 x 260 mm
Tray QTY: 100 pcs per tray
Carton QTY: 2,000 pcs per carton

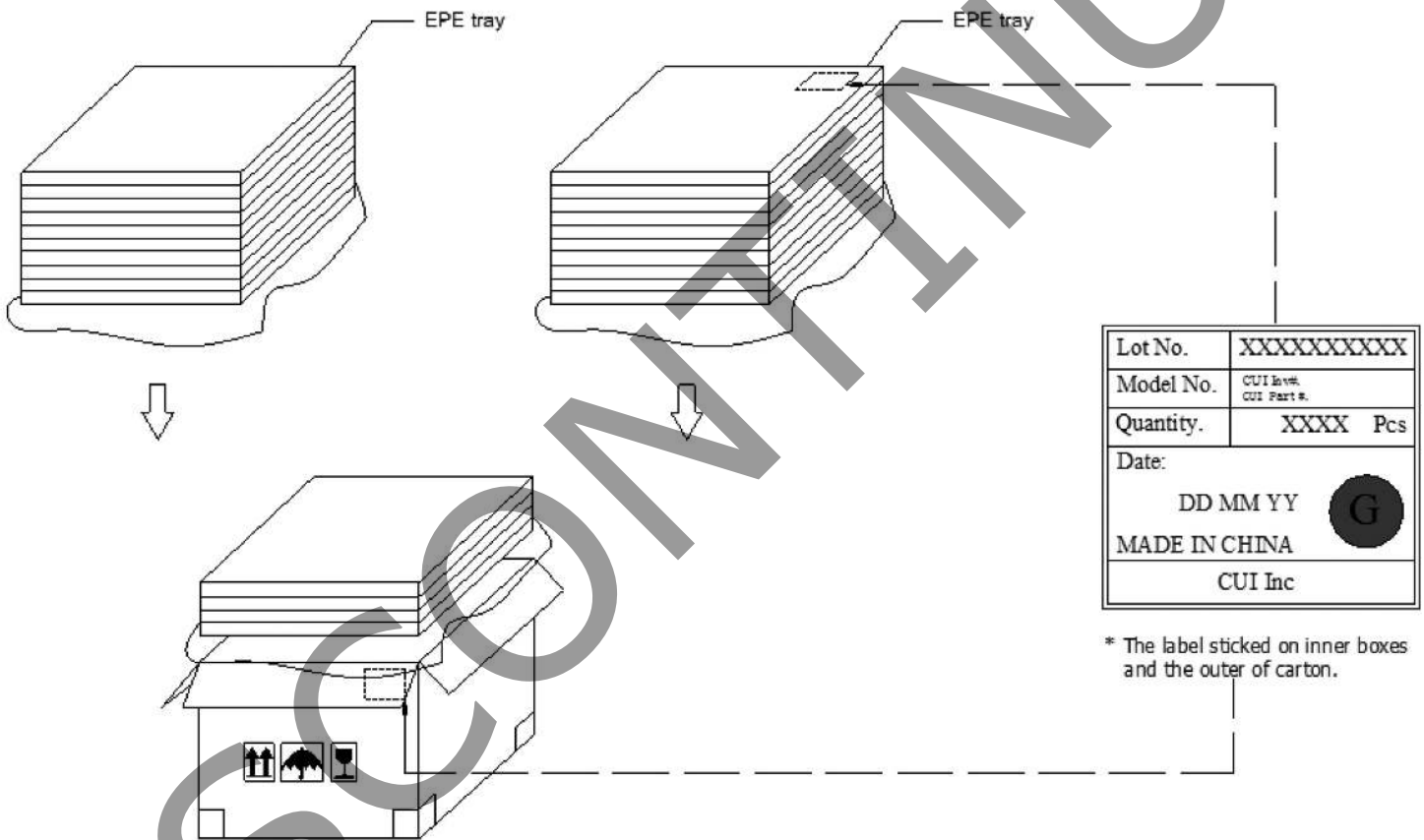

REVISION HISTORY

rev.	description	date
1.0	initial release	10/12/2016

The revision history provided is for informational purposes only and is believed to be accurate.



Headquarters
20050 SW 112th Ave.
Tualatin, OR 97062
800.275.4899

Fax 503.612.2383
cui.com
techsupport@cui.com

CUI offers a one (1) year limited warranty. Complete warranty information is listed on our website.

CUI reserves the right to make changes to the product at any time without notice. Information provided by CUI is believed to be accurate and reliable. However, no responsibility is assumed by CUI for its use, nor for any infringements of patents or other rights of third parties which may result from its use.

CUI products are not authorized or warranted for use as critical components in equipment that requires an extremely high level of reliability. A critical component is any component of a life support device or system whose failure to perform can be reasonably expected to cause the failure of the life support device or system, or to affect its safety or effectiveness.