



SL-156

TE Internal #: 2-770849-0

Housing, Receptacle, Wire-to-Board, 20 Position, .156 in [3.96 mm]
Centerline, Crimp, 1 Row, Natural, Mating Retention, Wire & Cable,
SL-156

[View on TE.com >](#)

Connectors > PCB Connectors > Wire-to-Board Connectors > Wire-to-Board Connector Assemblies & Housings >

Receptacle Housing: Wire-to-Board, with Mating Alignment, SL156



Connector Product Type: **Housing**

Connector & Housing Type: **Receptacle**

Connector System: **Wire-to-Board**

Number of Positions: **20**

Centerline (Pitch): **3.96 mm [.156 in]**

[All Receptacle Housing: Wire-to-Board, with Mating Alignment, SL156 \(107\)](#)

Features

Product Type Features

Connector Product Type	Housing
Connector & Housing Type	Receptacle
Connector System	Wire-to-Board
Sealable	No
Connector & Contact Terminates To	Wire & Cable

Configuration Features

Number of Positions	20
Number of Rows	1

Electrical Characteristics

Operating Voltage	250 VAC
-------------------	---------

Body Features

--	--



Primary Product Color	Natural
-----------------------	---------

Contact Features

Contact Retention Within Housing	Without
Contact Layout	Inline
Contact Type	Socket
Contact Current Rating (Max)	6.5 A

Termination Features

Termination Method to Wire & Cable	Crimp
------------------------------------	-------

Mechanical Attachment

Strain Relief	Without
PCB Mount Alignment	Without
Panel Mount Feature	Without
PCB Mount Retention	Without
Mating Retention Type	Locking Ramp
Mating Retention	With
Connector Mounting Type	Cable Mount (Free-Hanging)

Housing Features

Housing Material	Nylon - GF
Centerline (Pitch)	3.96 mm [.156 in]

Dimensions

	.25 in
Wire Size	.0509 – .823 mm ²

Usage Conditions

Operating Temperature Range	-55 – 105 °C [-67 – 221 °F]
-----------------------------	-----------------------------

Operation/Application

Circuit Application	Power & Signal
---------------------	----------------

Industry Standards

Agency/Standard	CSA, UL
UL Flammability Rating	UL 94V-0

Packaging Features

Packaging Quantity	500
--------------------	-----



Packaging Method

Bag & Box

Other

Discrete Wire Connector Comment

Unit Accepts 1.14[.045] Square or Round Post, Accepts Keying Plug 640254-1 and 640255-1

Product Compliance

[For compliance documentation, visit the product page on TE.com>](#)

EU RoHS Directive 2011/65/EU

Compliant

EU ELV Directive 2000/53/EC

Compliant

China RoHS 2 Directive MIIT Order No 32, 2016

No Restricted Materials Above Threshold

EU REACH Regulation (EC) No. 1907/2006

Current ECHA Candidate List: JUNE 2023 (235)
Candidate List Declared Against: JAN 2023 (233)
Does not contain REACH SVHC

Halogen Content

Low Halogen - Br, Cl, F, I < 900 ppm per homogenous material. Also BFR/CFR/PVC Free

Solder Process Capability

Not applicable for solder process capability

Product Compliance Disclaimer

This information is provided based on reasonable inquiry of our suppliers and represents our current actual knowledge based on the information they provided. This information is subject to change. The part numbers that TE has identified as EU RoHS compliant have a maximum concentration of 0.1% by weight in homogenous materials for lead, hexavalent chromium, mercury, PBB, PBDE, DBP, BBP, DEHP, DIBP, and 0.01% for cadmium, or qualify for an exemption to these limits as defined in the Annexes of Directive 2011/65/EU (RoHS2). Finished electrical and electronic equipment products will be CE marked as required by Directive 2011/65/EU. Components may not be CE marked. Additionally, the part numbers that TE has identified as EU ELV compliant have a maximum concentration of 0.1% by weight in homogenous materials for lead, hexavalent chromium, and mercury, and 0.01% for cadmium, or qualify for an exemption to these limits as defined in the Annexes of Directive 2000/53/EC (ELV). Regarding the REACH Regulation, the information TE provides on SVHC in articles for this part number is based on the latest European Chemicals Agency (ECHA) 'Guidance on requirements for substances in articles' posted at this URL: <https://echa.europa.eu/guidance-documents/guidance-on-reach>

Compatible Parts



TE Part # 2-644752-0
20P MTA156 HDR ASSY SQ STR F/L



TE Part # 2-640388-0
20P MTA156 HDR ASSY RN STR F/L



TE Part # 2-640389-0
20P MTA156 HDR ASSY SQ R/A F/L



TE Part # 90471-1
EXTRACTION TOOL, SC-156



Also in the Series | **SL-156**

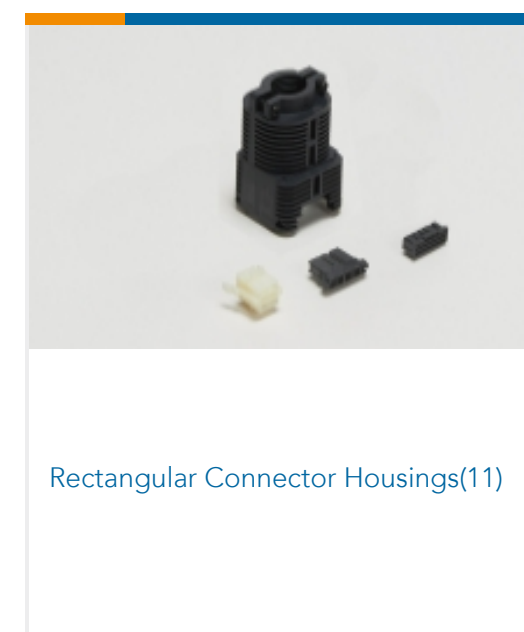
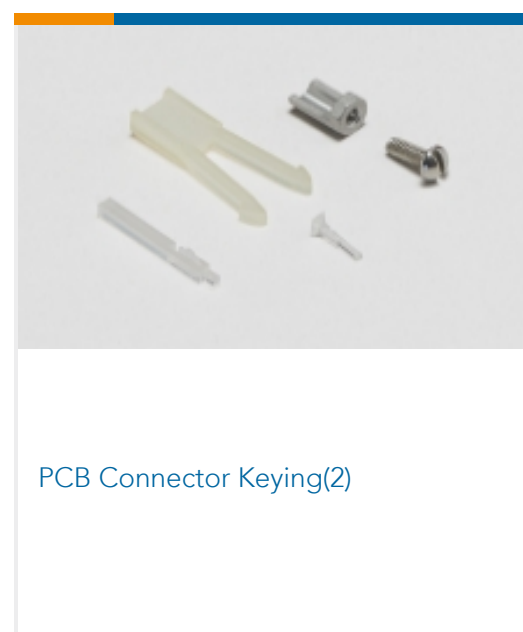
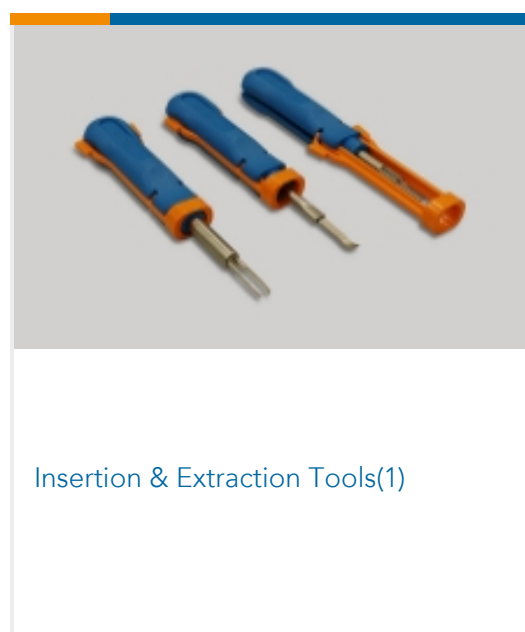



Rectangular Connector Keying Plugs(1)



Wire-to-Board Connector Assemblies & Housings(140)



Wire-to-Board Connector Contacts(23)

Customers Also Bought



TE Part #5-643819-0
20P MTA156 CONN ASSY 22AWG LF



TE Part #419437-000
CWT-1505

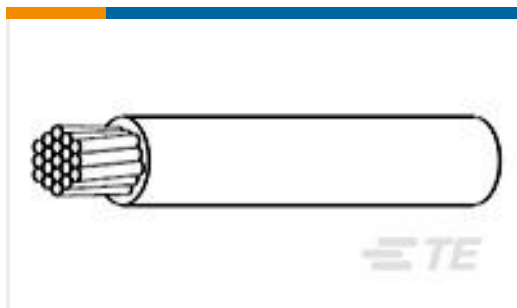

TE Part #311906-000
FLTWC0311-22-7

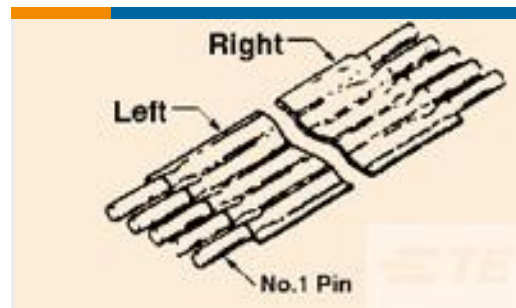

TE Part #7-1437166-5
FSP-22A-9



TE Part #1474659-5
FSN-26A-5



TE Part #2-640385-0
20P MTA156 HDR ASSY SQ R/A



TE Part #91359-2
PRO-CRIMPER II DIE ASSEMBLY

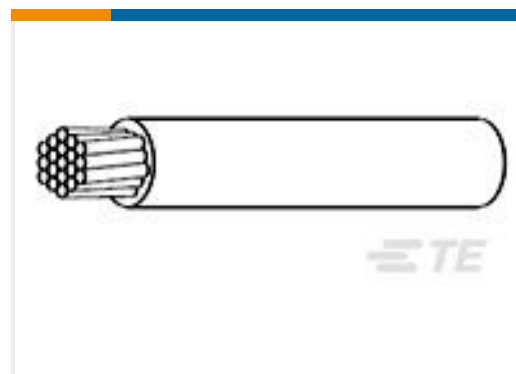

TE Part #346427-000
FLTWC0311-22-4

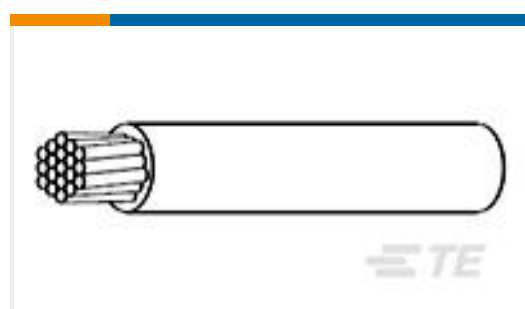

TE Part #900345-000
FLTWC0311-22-5

Documents

Product Drawings

20P SL156 HSG W/LCK RMP & TABS

English

CAD Files

3D PDF

3D

Customer View Model

ENG_CVM_CVM_2-770849-0_Z_c-2-770849-0-z.2d_dxf.zip



English

Customer View Model

[ENG_CVM_CVM_2-770849-0_Z_c-2-770849-0-z.3d_igs.zip](#)

English

Customer View Model

[ENG_CVM_CVM_2-770849-0_Z_c-2-770849-0-z.3d_stp.zip](#)

English

By downloading the CAD file I accept and agree to the [Terms and Conditions](#) of use.

Product Specifications

[Application Specification](#)

English

Agency Approvals

[UL Report](#)

English