

**Integrated AMR Angle Sensor and Signal Conditioner with Differential Outputs**

**FEATURES**

- ▶ Full featured evaluation board for the [ADA4570](#)
- ▶ PC control in conjunction with the System Demonstration Platform (SDP) ([EVAL-SDP-CS1Z](#), SDP-S or [EVAL-SDP-CB1Z](#), SDP-B)
- ▶ PC software for data measurement and display

**EVALUATION KIT CONTENTS**

- ▶ EVAL-ADA4570SDZ evaluation board
- ▶ ADA4570 magnet stimulus
  - ▶ Dipole magnet
  - ▶ Hand movable mounting

**ADDITIONAL HARDWARE REQUIRED**

- ▶ The SDP-S or the SDP-B controller board with a USB cable

**ADDITIONAL SOFTWARE REQUIRED**

- ▶ [EVAL-ADA4570SDZ Software Installer](#)

**GENERAL DESCRIPTION**

The ADA4570 is an anisotropic magnetoresistive (AMR) sensor with integrated signal conditioning amplifiers and analog-to-digital converter (ADC) drivers. The ADA4570 produces two differential analog output pairs that indicate the angular position of the surrounding magnetic field.

The EVAL-ADA4570SDZ evaluation board features the ADA4570 in an end of shaft magnet configuration.

The evaluation kit is composed of the EVAL-ADA4570SDZ and a magnetic stimulus on a printed circuit board (PCB) mount. To interface to a computer, the EVAL-SDP-CS1Z (SDP-S) or the EVAL-SDP-CB1Z (SDP-B) is required which must be ordered separately.

An illustration of the ADA4570 evaluation system consisting of the PC graphic user interface (GUI), the SDP, and the EVAL-ADA4570SDZ is shown in [Figure 1](#). In this user guide, SDP refers to either the SDP-S or the SDP-B interface card.

The EVAL-ADA4570SDZ allows a detailed evaluation of the ADA4570 where the software GUI demonstrates angular measurement and performs system level calibration.

The EVAL-ADA4570SDZ also provides access via a standard header for power and digital signals to the on-board ADC interface ([AD7266](#)), which allows evaluation of the ADA4570 with a user preferred microcontroller platform and to start the system software development. Users can also access the analog output signals of the ADA4570 to a user preferred ADC with a microcontroller platform.

The PCB is designed so that the sensor board can be detached from the SDP interface to provide a smaller form factor. Power supplies can be sourced from either the USB port via the SDP card or an external bench supply.

For full details, see the [ADA4570](#) data sheet, which must be used in conjunction with this user guide when using the EVAL-ADA4570SDZ.

**ADA4570 END OF SHAFT MAGNETIC EVALUATION SYSTEM**

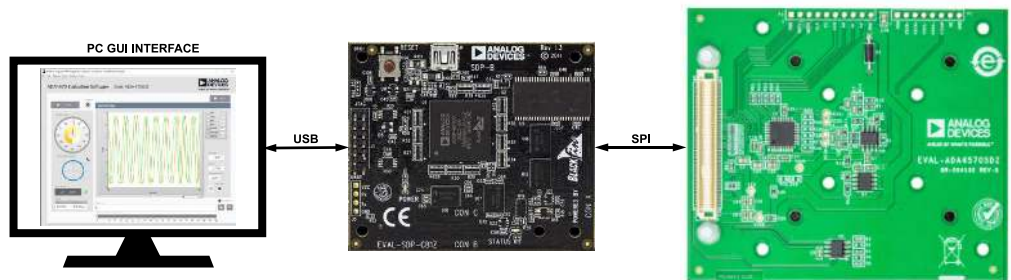

*Figure 1. ADA4570 End of Shaft Magnetic Evaluation System Consisting of the PC GUI, the SDP, and the EVAL-ADA4570SDZ*

**TABLE OF CONTENTS**

Features.....	1	Evaluation Board Quick Start .....	6
Evaluation Kit Contents.....	1	Software Installation Procedures.....	6
Additional Hardware Required.....	1	Evaluation Board Software.....	8
Additional Software Required.....	1	Starting the Evaluation GUI.....	8
General Description.....	1	Overview of the Main ADA4570 Evaluation	
ADA4570 End of Shaft Magnetic Evaluation		Software GUI Window.....	9
System.....	1	Evaluation Board Schematics and Silkscreen.....	13
Getting Started.....	3	Ordering Information .....	16
Quick Start Steps.....	3	Evaluation Board Bill of Materials.....	16
Evaluation Board Hardware.....	4	Notes.....	17
Configuration of the EVAL-ADA4570SDZ.....	4		

**REVISION HISTORY****7/2021—Revision 0: Initial Version**

## GETTING STARTED

### QUICK START STEPS

The SDP is the controller board, which is the communication link between the PC and the EVAL-ADA4570SDZ, and provides the serial peripheral interface (SPI) required to transfer ADA4570 data sampled by the ADC directly to the host PC.

Note that the [evaluation software](#) and the SDP USB driver must be installed before connecting the EVAL-ADA4570SDZ board and the SDP board to the USB port of the PC to ensure that the evaluation system is correctly recognized when the EVAL-ADA4570SDZ is connected.

The **SDP USB Driver Installer** can be found by following the **Software** tab on the [EVAL-SDP-CS1Z \(SDP-S\)](#) or the [EVAL-SDP-CB1Z \(SDP-B\)](#) product pages.

To begin using the EVAL-ADA4570SDZ, take the following steps:

1. Connect the SDP board to the EVAL-ADA4570SDZ (see [Figure 2](#)).
2. Slide the EVAL-ADA4570SDZ into the magnet mounting bracket at the bottom PCB mount side rail. To correctly align the magnet with the ADA4570 sensor, ensure that the EVAL-ADA4570SDZ is fully inserted into the magnet PCB mount.
3. Connect the SDP board to the computer using the supplied USB cable (USB Type A to Mini-B).
4. To launch the EVAL-ADA4570SDZ software, click the Windows® key to open the Windows **Start** menu and **Programs** list. Navigate to **Analog Devices** and click **EVAL-ADA4570SDZ**.

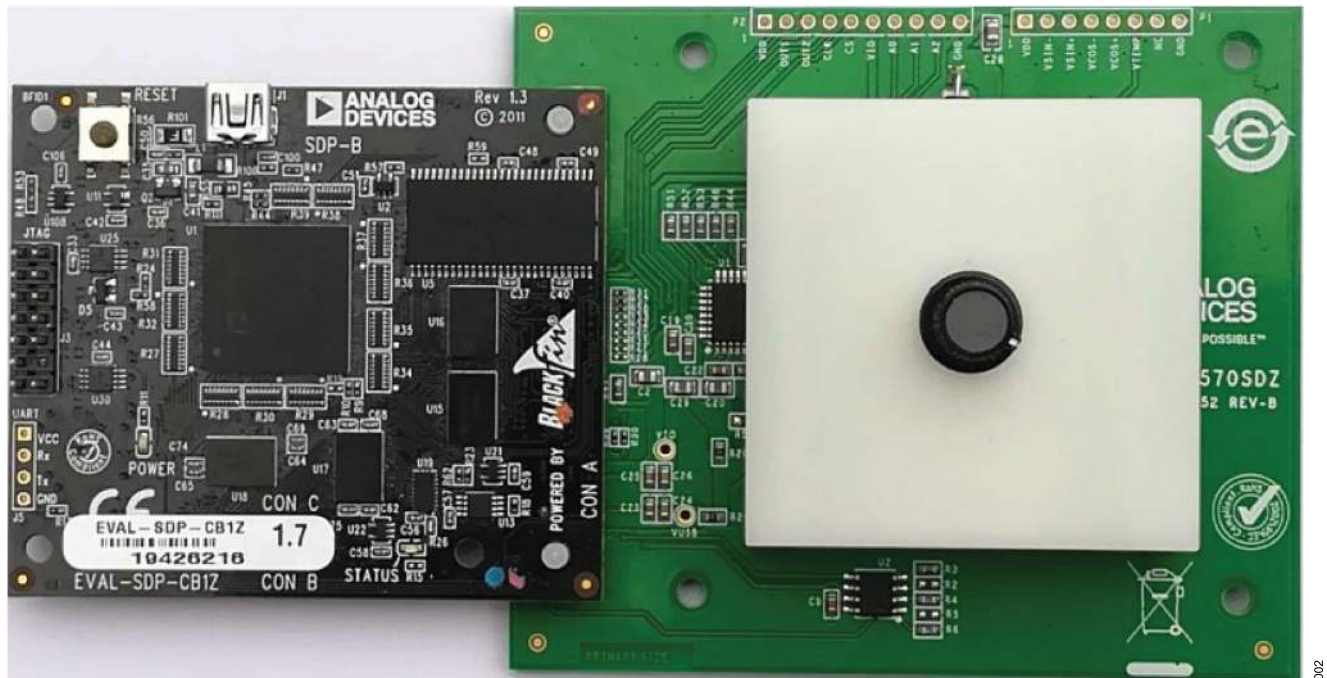

Figure 2. Hardware Configuration Showing the Demonstration Magnet Assembly, EVAL-ADA4570SDZ, and the SDP-B

## EVALUATION BOARD HARDWARE

The EVAL-ADA4570SDZ end of shaft evaluation system comprises a PCB with the [ADA4570](#), an [AD7266](#) ADC, and an external mountable magnetic stimulus.

### CONFIGURATION OF THE EVAL-ADA4570SDZ

The EVAL-ADA4570SDZ was designed to provide flexibility for users. The following configurations are available:

- ▶ SDP and Analog Devices, Inc, software controlled
- ▶ Using an external digital interface
- ▶ A direct analog interface with the [ADA4570](#) sensor

If an external power supply is connected to supply the EVAL-ADA4570SDZ, the current limitation of the external power supply must be set to 100 mA as a precaution.

### SDP and Analog Devices Software Controlled

The ADA4570 evaluation system can be powered directly from the host PC USB by the SDP controller board via the P3 connector.

**Table 1. P3 Socket for the SDP Interface**

Pin Number	Function	Description
3, 4, 6, 11, 23, 28, 36, 40, 46, 52, 58, 63, 69, 75, 81, 86, 93, 98, 104, 109, 115, 117, 118	GND	System ground
5	5 V supply	5 V supply from the USB port of the connected PC
43	REF_SESELECT	Reference voltage select
44	RANGE	Input range select
45	SGL/DIFF	Differential and single-ended select
56	EEPROM_A0	Address A0 of the board identifier EEPROM
76	GPIO5	SDP general-purpose input and output (GPIO)
77	GPIO3	SDP GPIO
78	GPIO1	SDP GPIO
79	I <sup>2</sup> C SCL	I <sup>2</sup> C clock
80	I <sup>2</sup> C SDA	I <sup>2</sup> C data
82	SPI SCL	SPI clock
83	SPI SDO	SPI slave data out
84	SPI SDI	SPI slave data in
85	SPI	SPI chip select for the GPIO expander, SDP Chip Select A
116	3.3 V supply	Main supply for supporting devices

tor. Use the CON A connector of the SDP controller board to connect to P3 (see [SDP and Analog Devices Software Controlled](#)). The Connector P3 pinout with the used SDP connections for the EVAL-ADA4570SDZ is listed in [Table 1](#), which is the recommended configuration for the user to quickly achieve high performance measurement.

This configuration uses the SDP to communicate with the [AD7266](#) ADC to sample the sensor output and display the data with the software provided.



**Figure 3. Connector P3 to Interface SDP and EVAL-ADA4570SDZ**

EVALUATION BOARD HARDWARE

Using an External Digital Interface

The EVAL-ADA4570SDZ facilitates a configuration option where the user can connect an external microcontroller or field program-able gate array (FPGA) to the on-board AD7266 ADC (see Figure 4).

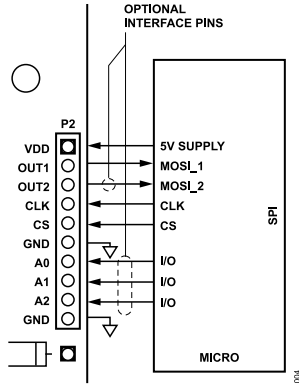

Figure 4. Typical Connection Diagram for Using the Digital Interface

Connector P2, shown in Figure 4, provides the required connectivity to power the AD7266 ADC and the ADA4570 as well as the interface to the AD7266 ADC. This configuration allows users to monitor the digitized output of the ADA4570 with a user preferred embedded hardware platform. The pinout of Connector P2 is listed in Table 2. The SDP controller board supports a maximum SPI speed of 10 MHz, which limits the sampling rate of the AD7266 ADC to 625 kSPS. This configuration can be used to facilitate data acquisition with a faster sampling rate up to 2 MSPS.



Figure 5. Connector P2 for Access to the SPI of the ADC of the EVAL-ADA4570SDZ

Table 2. Optional Digital Interface Connection of P2

Pin Name	Input Type	Description
VDD	Supply	The 5 V input that supplies the evaluation board.
OUT1, OUT2, CLK, CS	Digital inputs and outputs	SPI.
VIO	Supply and digital input for	When used in this configuration, VIO selects the AD7266 ADC reference source. If high, it is the external ADC reference, and if low it is the internal 2.5 V reference.
A0, A1, A2	Digital inputs	Digital inputs to control the input channel of the ADC. The Ax pins can control which output configuration is sampled by the on-board ADC.
GND	Ground	Ground connection of the EVAL-ADA4570SDZ.

For full details about the SPI and how to interface the different pins, refer to the EVAL-ADA4570SDZ schematics (see Figure 27 and Figure 28) and the AD7266 data sheet.

Direct Analog Interface with the ADA4570

The EVAL-ADA4570SDZ facilitates a configuration option where the user can connect an external ADC to the ADA4570 output signals (see Figure 6).

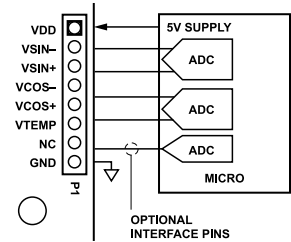

Figure 6. Typical Connection Diagram for Using Direct Access to the ADA4570 Sensor

Connector P1, shown in Figure 7, provides the required connectivity to supply the ADA4570 and access to the ADA4570 output signals for the external ADC. This configuration allows users to sample the sine and cosine outputs of the ADA4570 with a user preferred differential ADC. The pinout of Connector P1 is listed in Table 3.

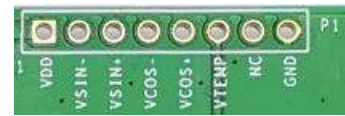

Figure 7. Connector P1 for Direct Access to the Sensor Output

Table 3. Optional Analog Interface Connection of P1

Pin Name	Input Type	Description
VDD	Supply	5 V supply of the EVAL-ADA4570SDZ
VSIN-	Analog output	Negative analog sine output from the ADA4570
VSIN+	Analog output	Positive analog sine output from the ADA4570
VCOS-	Analog output	Negative analog cosine output from the ADA4570
VCOS+	Analog output	Positive analog cosine output from the ADA4570
VTEMP	Analog output	Analog output from the ADA4570
NC	Ground	No connect pin
GND	Ground	Ground connection of the EVAL-ADA4570SDZ

For full details about the ADA4570 sensor interface and how to connect the device, refer to the EVAL-ADA4570SDZ schematics (see Figure 27 and Figure 28) and the ADA4570 data sheet.

**EVALUATION BOARD QUICK START**

The EVAL-ADA4570SDZ evaluation board can be controlled with the [EVAL-ADA4570SDZ Evaluation Board Software](#). The following sections provide instructions for installing the supporting software and an overview for connecting the hardware to the PC.

**SOFTWARE INSTALLATION PROCEDURES**

**Installing the EVAL-ADA4570SDZ Evaluation Software**

To install the EVAL-ADA4570SDZ evaluation software, take to the following steps:

1. Start the Windows operating system of the PC and download the [ADA4570 Evaluation Board Installer](#) software.
2. Unzip the downloaded file. Run the **setup.exe** file.
3. Click the **setup.exe** file to begin installing the evaluation software. The software installation window opens as shown in [Figure 8](#).



*Figure 8. EVAL-ADA4570SDZ Evaluation Software Install Window*

4. Choose the installation directory and click **Next**. The default location is **C:\Program Files (x86)\Analog Devices**.

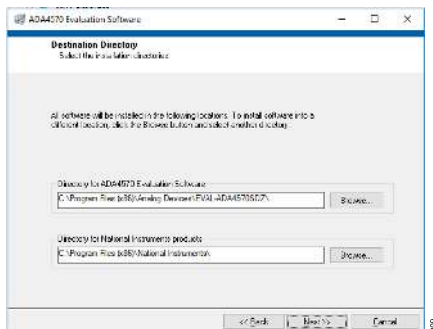

*Figure 9. Destination Directory Window*

5. Installing the **EVAL-ADA4570SDZ Evaluation Software** requires users to accept the license agreement shown in [Figure 10](#). Read the agreement before clicking **Next** to proceed.



*Figure 10. License Agreement Window*

6. The window shown in [Figure 11](#) provides a summary of the software installation. Click **Next** to install the software listed in the window.

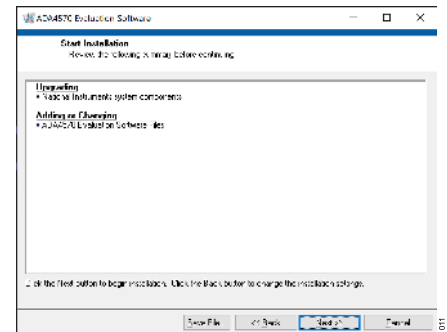

*Figure 11. Start Installation Window*

7. A pop-up window then opens and displays a bar showing the installation progress, as shown in [Figure 12](#).

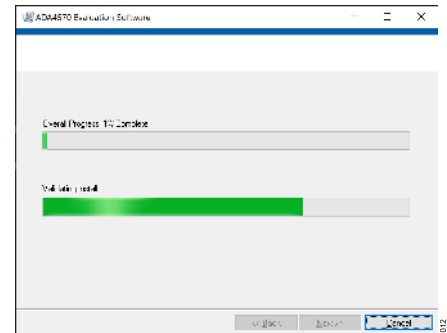

*Figure 12. Overall Progress*

The installation then completes, and the next step is to install the SDP drivers.

## EVALUATION BOARD QUICK START

### SDP Installation

To install the SDP drivers, download the **SDPDrivers.exe** file from the SDP product page ([SDP-S](#) or [SDP-B](#)) and complete the following steps:

1. To initialize the installation, run the **SDPDrivers.exe** executable file.
2. When the SDP drivers setup wizard appears, click **Next** (see [Figure 13](#)).



Figure 13. SDP Driver Setup Wizard

3. When the **Choose Install Location** window appears (see [Figure 14](#)), click **Install**. To select a different destination folder, click **Browse**, select a destination, then click **Install**.

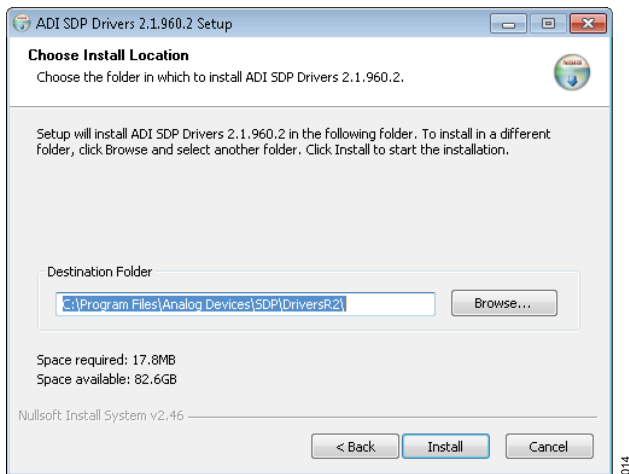

Figure 14. Choose Install Location Window

4. Click **Finish** to complete the installation of the SDP drivers.
5. When plugging in the SDP controller board via the provided USB cable, allow the **Found New Hardware Wizard** to run. Check that the SDP drivers are installed and that the SDP controller board are connected properly by checking the **Device Manager** of the PC. If the drivers and board are connected properly, the **Analog Devices System Demonstration Platform SDP** appears under **ADI Development Tools** (see [Figure 15](#)).

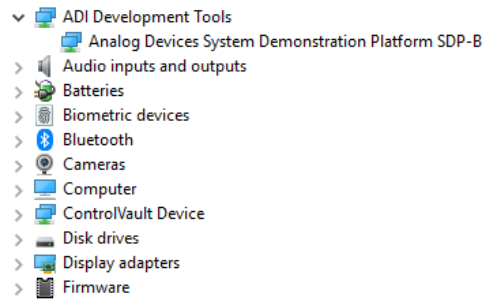

Figure 15. Device Manager Menu

6. The computer now recognizes the SDP controller board, and the EVAL-ADA4570SDZ Evaluation Software can be opened.

### Uninstalling the Software

To uninstall the EVAL-ADA4570SDZ Evaluation Software, take the following steps:

1. Launch the **Uninstall Wizard** by navigating to **Start > Control Panel > Programs and Features > EVAL-ADA4570SDZ** to open a window with the **Uninstall** button.
2. Click **Uninstall**.
3. Click **Yes** in the confirmation window that appears.

To uninstall the SDP drivers, adhere to the following steps:

1. Launch the **Uninstall Wizard** by navigating to **Start > Control Panel > Programs and Features > ADI SDP Drivers** to open a window with the **Uninstall** button.
2. Click **Uninstall**.
3. Click **Yes** in the confirmation window that appears.

## EVALUATION BOARD SOFTWARE

### STARTING THE EVALUATION GUI

To use the EVAL-ADA4570SDZ with the SDP controller board, start by connecting the two boards together with the CON A connector of the SDP.

When launching the GUI, the SDP controller board must be recognized by the GUI before proceeding. The GUI automatically searches for the SDP controller board and tries to read the EEPROM identification of the EVAL-ADA4570SDZ and to ensure that the correct program is in use.

If the SDP controller board is not connected, or if the drivers are not installed correctly, a **Hardware Select** window appears (see [Figure 16](#)). If this occurs, ensure that the drivers are installed correctly and that the PC recognizes the SDP controller board.

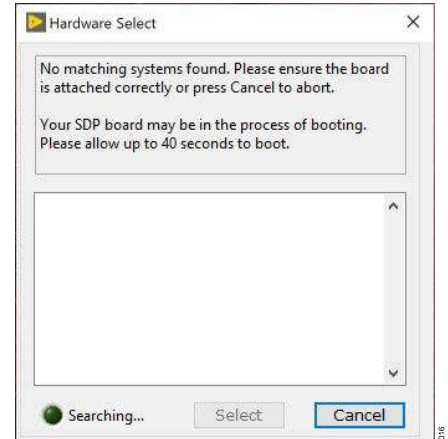

**Figure 16. Hardware Select Window**

The **Hardware Select** window also appears when the EVAL-ADA4570SDZ is not recognized or is not connected to the SDP controller board. When the EVAL-ADA4570SDZ is detected, the board appears preselected in the **Hardware Select** window. Click **Select** to continue.



### EVALUATION BOARD SOFTWARE

#### OVERVIEW OF THE MAIN ADA4570 EVALUATION SOFTWARE GUI WINDOW

Figure 17 shows the main EVAL-ADA4570SDZ GUI window when starting the ADA4570 Evaluation Board Software.

Initially, all plots are blank, and the data capture is preset for data acquisition of the differential VSIN and VCOS signals data capture. Click **Start** to begin the data acquisition, and the **Captured Data** window of the GUI displays the selected signals.

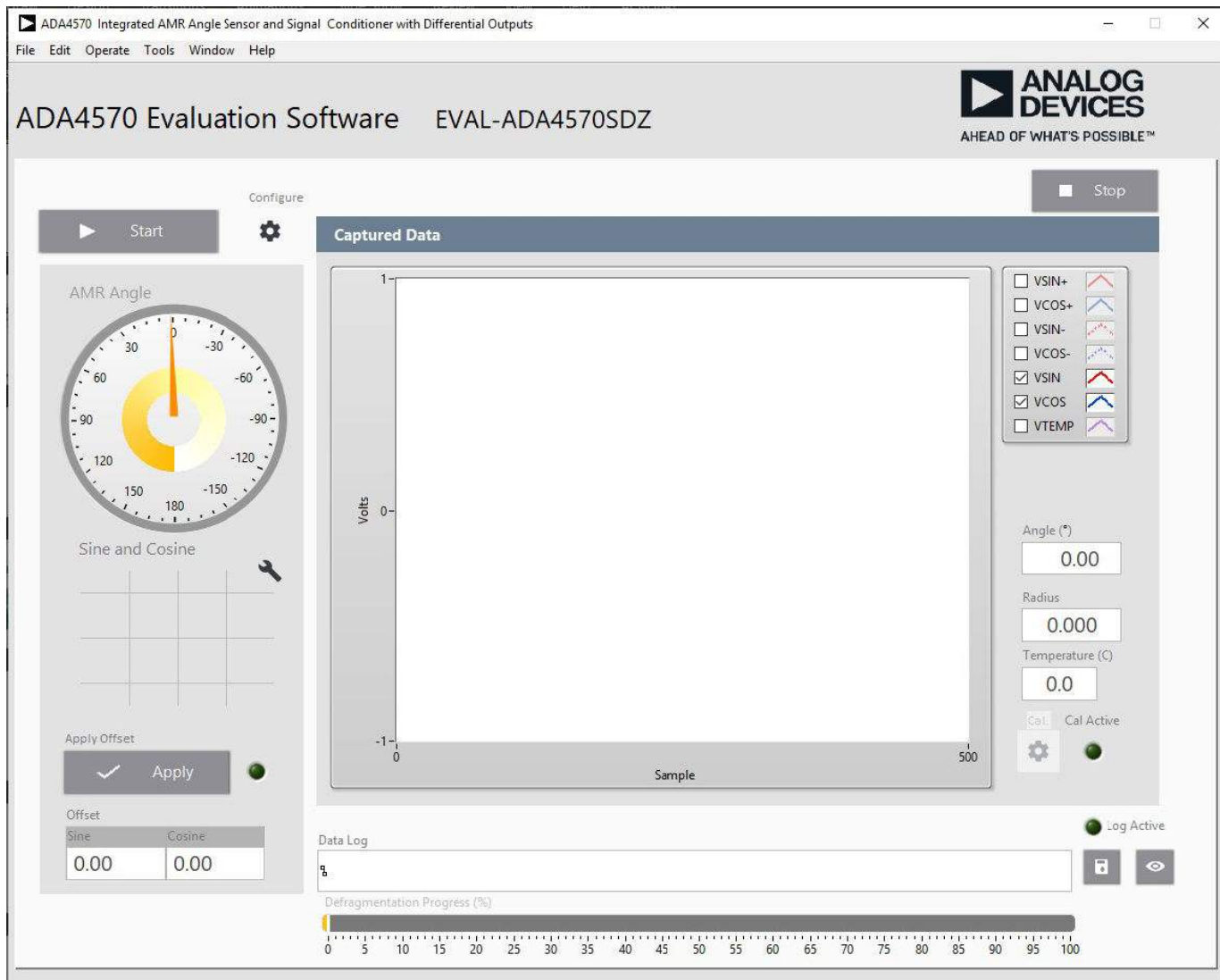

Figure 17. ADA4570 Evaluation Board Software (EVAL-ADA4570SDZ) Main Window

## EVALUATION BOARD SOFTWARE

## VSIN and VCOS Raw Outputs

The **Captured Data** graph shows measurement result in volts of the selected outputs from the ADA4570 magnetic angle sensor (see [Figure 18](#)).

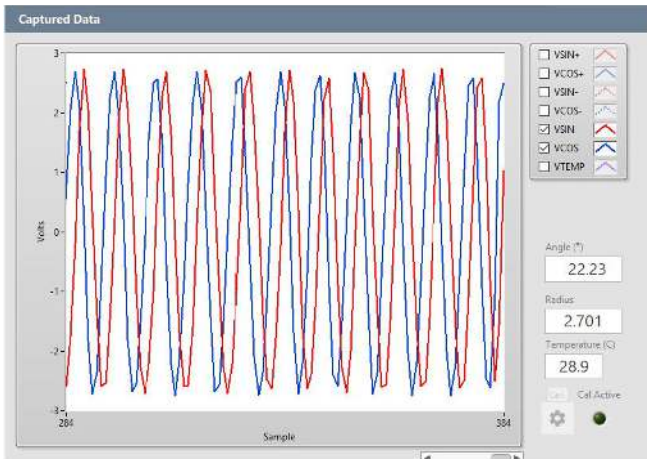

Figure 18. Captured Data Graph

The red and blue waveforms in [Figure 18](#) indicate the differential signals of the selected VSIN channel and VCOS channel outputs as the magnet rotates over the ADA4570. The VSIN and VCOS differential signals output data is used to calculate the angle and radius.

In the application, it is important that these two channels are simultaneously sampled to avoid the introduction of errors resulting in a phase delay between the sampling of the individual channels.

## GUI Settings and Capture Modes

The GUI allows the user to change some settings that are accessed via the system icon, **Configure** (see [Figure 19](#)).



Figure 19. Configure Icon

When the **Configure** icon is activated, the GUI opens a window that allows the user to modify the captured data display settings, data accusation and update rate settings, and the method the data is captured. [Figure 20](#) shows the GUI default settings.

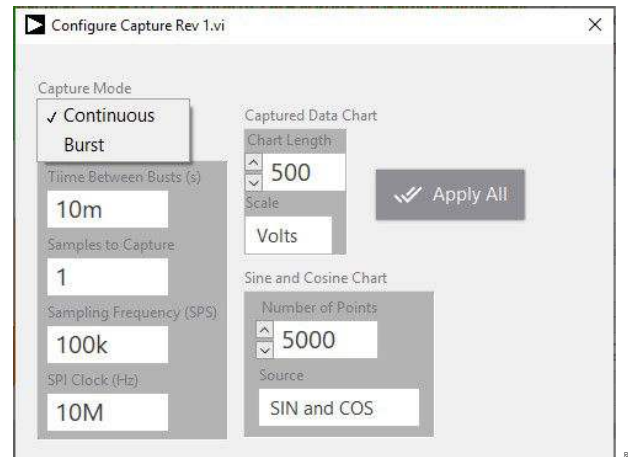

Figure 20. Configure Window

The GUI provides two capture modes, **Continuous** and **Burst**.

When the EVAL-ADA4570SDZ operates in continuous capture mode, the GUI constantly samples the VSIN channel and VCOS channel. The number of samples displayed is set with the **Chart Length** field and, by default, is set to 500 samples. The GUI allows the user to set delays between sample reads via the **Time Between Bursts (s)** field. The default delay is set to 10 ms.

After every sample read by the GUI, the **Captured Data** graph, the angle, the radius, and the temperature values are updated.

When the EVAL-ADA4570SDZ operates in burst read mode, the GUI samples a burst of samples, defined in the **Samples to Capture** field, without updating the display. After the burst read has finished, the GUI updates the display values with the collected data. By default, the sampling frequency is set to 100,000 SPS.

EVALUATION BOARD SOFTWARE

Electrical Angle

The electrical angle plot displays the calculated arctan2 (angle) value in a visual format, as shown in Figure 21.

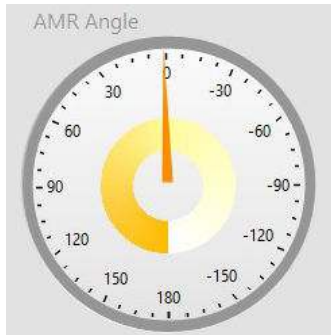

Figure 21. Electrical Angle Plot

Sine and Cosine Plot

The sine and cosine plot, shown in Figure 22, displays VSIN vs. VCOS (differential signals) from the ADA4570. The radius calculated from VSIN and VCOS is indicated in the **Radius** indicator shown in Figure 18.

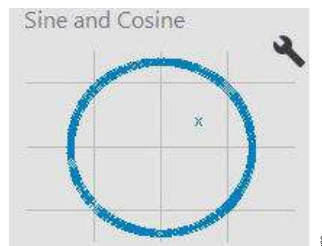

Figure 22. Sine and Cosine Plot

Offset Calibration

An offset calibration may be required to maximize the accuracy of the ADA4570. See the ADA4570 data sheet for full details on the offset voltage ranges for the outputs.

The EVAL-ADA4570 GUI uses a maximum and a minimum output value to calculate the VSIN channel and the VCOS channel offsets. The GUI requires the user to perform at least one full electric angle rotation to determine a meaningful offset value.

Click **Apply Offset** to enable the offset calibration. When the calibration is applied, the light emitting diode (LED) turns bright green (see Figure 23).



Figure 23. Offset Calibration Pane

Temperature Calibration

The EVAL-ADA4570SDZ GUI also allows the user to perform a single point temperature calibration for the temperature channel indicated in Figure 24.

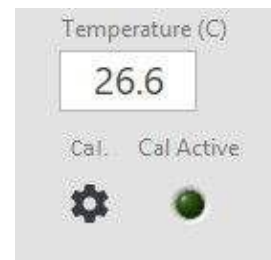

Figure 24. Temperature Calibration Pane

Click the **Cal.** symbol to open a window to enter a reference temperature. The GUI uses this temperature to calculate the offset and applies it to the temperature measurement when the **Cal Active** LED is enabled by the user (see Figure 25).



Figure 25. Temperature Calibration Activated

## EVALUATION BOARD SOFTWARE

### Data Logging

The EVAL-ADA4570SDZ GUI provides functionality that allows the user to store the collected data into a file for post processing and analysis.

Click the **File** symbol, shown in [Figure 26](#), and a window opens that allows the user to select the storage path and define a file name. A default file name is provided consisting of the device name, date, and time. The file format is predefined as .tdms.

The .tdms file is a binary format useful for storing large sets of data. The data file is automatically defragmented at the end of a capture sequence as indicated by the **Defragmentation Progress (%)** indicator shown in [Figure 26](#).

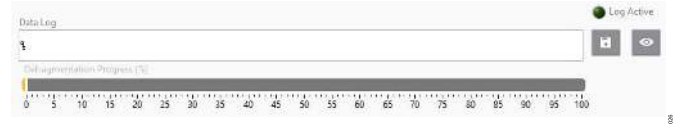

**Figure 26. Data Log**

The data logging function is immediately activated after confirming the log file details. The logging can be stopped by clicking on the **File** symbol again. To view the log file, click the **Eye** symbol to open a window that points to the location where the log file is stored. The user can then select the log file of interest by double-clicking on the file to open it in Excel. Note that users must install an add-in for Excel to view the .tdms file. The .tdms Excel add-in is available as a free download from the National Instrument website.

EVALUATION BOARD SCHEMATICS AND SILKSCREEN

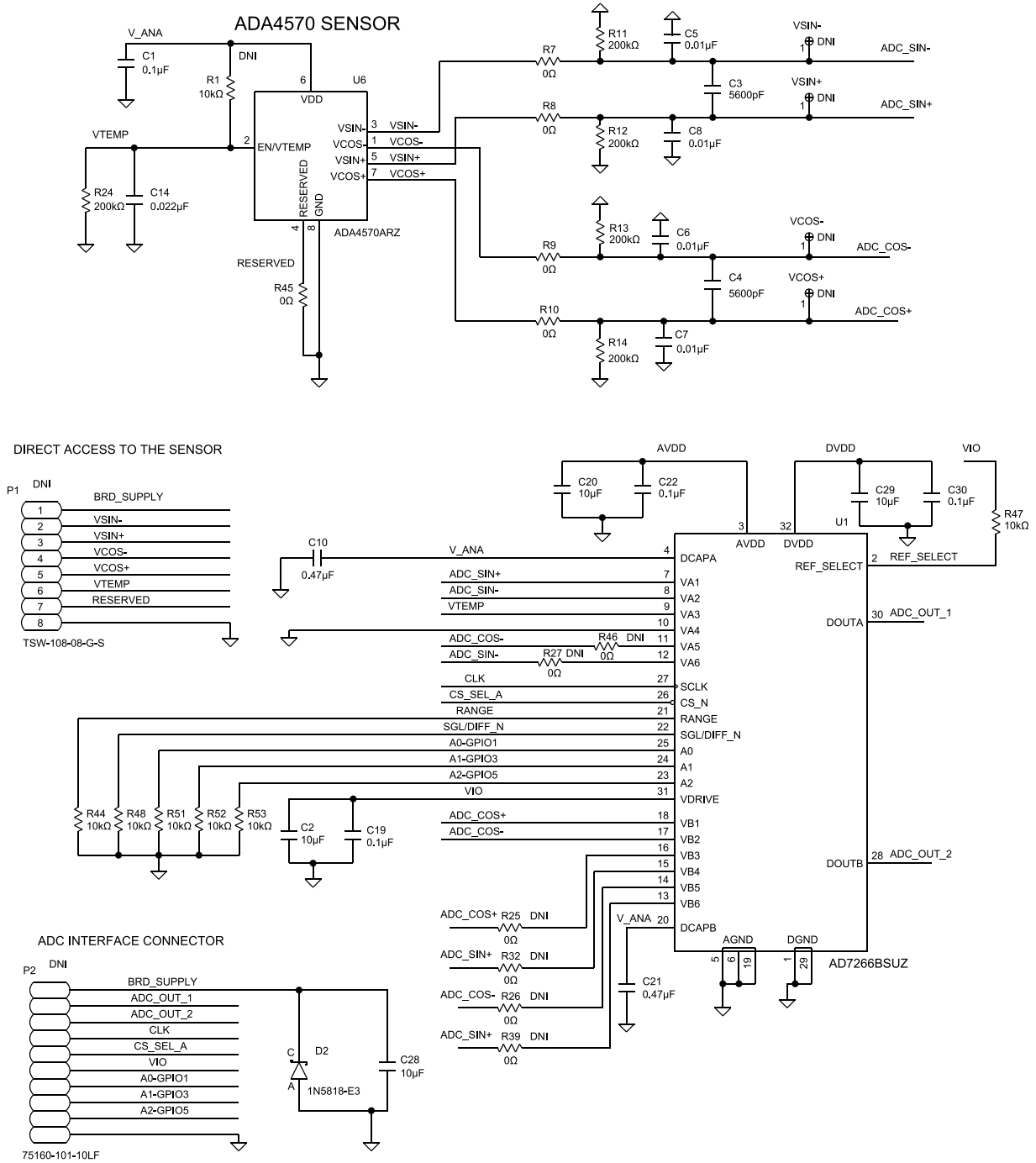

Figure 27. ADA4570 with AD7266

027

EVALUATION BOARD SCHEMATICS AND SILKSCREEN

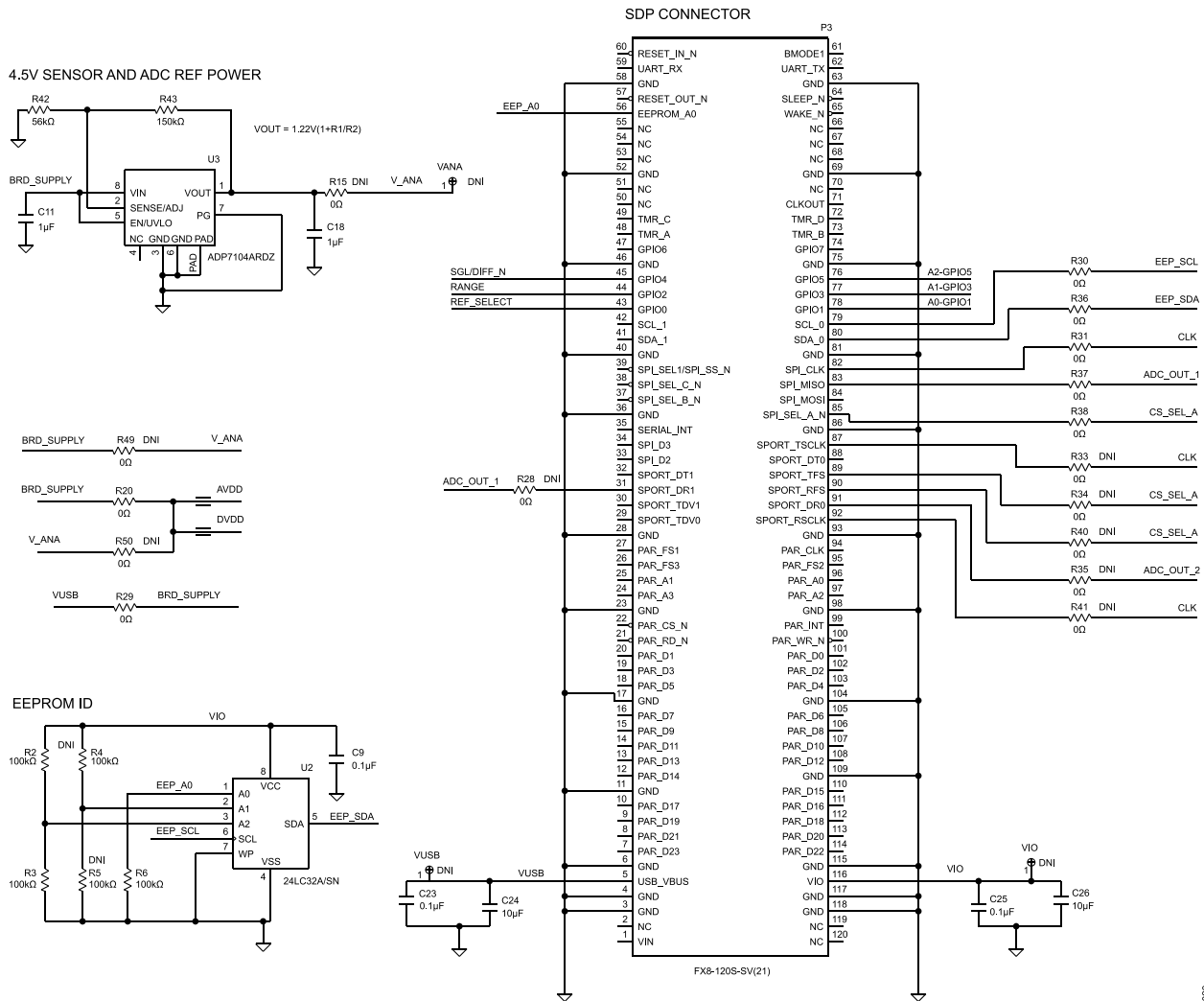

Figure 28. SDP Connector and Voltage Supply

028

EVALUATION BOARD SCHEMATICS AND SILKSCREEN

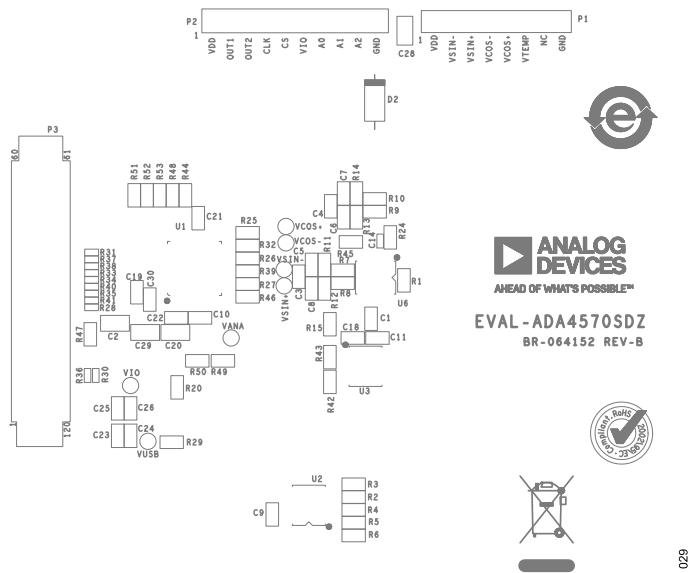

Figure 29. EVAL-ADA4570SDZ Silkscreen

## ORDERING INFORMATION

## EVALUATION BOARD BILL OF MATERIALS

Table 4. Bill of Materials

Reference Designator	Description	Manufacturer	Part Number
C1, C9, C19, C22, C23, C25, C30	0.1 $\mu$ F capacitors, 16 V, 10%, X7R, 0603	Kemet	C0603C104K4RAC
C2, C20, C29	10 $\mu$ F capacitors, 6.3 V, 20%, 0805	Taiyo Yuden	JMK212BJ106MG-T
C3, C4	5600 pF capacitors, 50 V, 10%, X7R, 0603	Samsung	CL10B562KB8NNNC
C5, C6, C7, C8	0.01 $\mu$ F capacitors, 50 V, 10%, X8R, 0603	TDK	CGA3E2X8R1H103K080AA
C10, C21	0.47 $\mu$ F capacitors, 25 V, 10%, X8R, 0603	Murata	GCG188R91E474K
C11, C18	1 $\mu$ F capacitors, 16 V, 10%, X7R, 0603	AVX	0603YC105KAT2A
C14	0.022 $\mu$ F capacitor, 25 V, 10%, X7R, 0402	Samsung	CL05B223KA5NNNC
C24, C26	10 $\mu$ F capacitors, 6.3 V, 20%, X5R, 0603	Murata	GRM188R60J106ME47D
C28	10 $\mu$ F capacitor, 16 V, 10%, X5R, 0805	Murata	GRM21BR61C106KE15L
D2	Schottky diode, DO41A	Vishay	1N5818-E3
P3	SDP connector	HRS	FX8-120S-SV(21)
R3, R4, R6	100 k $\Omega$ resistors, 1%, 1/10 W, 0603	Vishay	CRCW0603100KFKEA
R7 to R10, R15, R20, R29, R45	0 $\Omega$ resistors, 1/10 W, 0603	Yageo	RC0603JR-070RL
R11 to R14, R24	200 k $\Omega$ resistors, 1%, 1/10 W, 0603	Panasonic	ERJ-3EKF2003V
R30, R31, R36 to R38	0 $\Omega$ resistors, 1/16 W, 0402	Stackpole Electronics, Inc.	RMCF0402ZTOR00
R42	56 k $\Omega$ resistor, 1%, 1/10 W, 0603	Panasonic	ERJ-3EKF5602V
R43	150 k $\Omega$ resistor, 1%, 1/10 W, 0603	Panasonic	ERJ-3EKF1503V
R44, R47, R48, R51 to R53	10 k $\Omega$ resistors, 1%, 1/10 W, 0603	Panasonic	ERJ-3EKF1002V
U1	Differential/single-ended input, dual, simultaneous sampling, 2 MSPS, 12-bit, 3-channel SAR ADC	Analog Devices	<a href="#">AD7266BSUZ</a>
U2	I <sup>2</sup> C EEPROM, 32 kb, 8-lead SOIC	Microchip Technology	24LC32A/SN
U3	20 V, 500 mA, low noise, CMOS low dropout (LDO) regulator	Analog Devices	<a href="#">ADP7104ARDZ-R7</a>
U6	Integrated AMR angle sensor and signal conditioner with differential outputs	Analog Devices	<a href="#">ADA4570BRZ</a>
P1	8-pin connector (2.54 mm pitch), do not install (DNI)	Samtec	TSW-108-08-G-S
P2	10-pin connector (2.54 mm pitch), DNI	Samtec	TSW-110-18-T-S
R1	10 k $\Omega$ resistor, 1%, 1/10 W, 0603, DNI	Panasonic	ERJ-3EKF1002V
R2, R5	100 k $\Omega$ resistors, 1%, 1/10 W, 0603, DNI	Vishay	CRCW0603100KFKEA
R25 to R27, R32, R39, R46, R49, R50	0 $\Omega$ resistors, 1/10 W, 0603, DNI	Yageo	RC0603JR-070RL
R28, R33 to R35, R40, R41	0 $\Omega$ resistors, 1/16 W, 0402, DNI	Stackpole Electronics, Inc.	RMCF0402ZTOR00



## ORDERING INFORMATION

## NOTES

I<sup>2</sup>C refers to a communications protocol originally developed by Philips Semiconductors (now NXP Semiconductors).



### ESD Caution

**ESD (electrostatic discharge) sensitive device.** Charged devices and circuit boards can discharge without detection. Although this product features patented or proprietary protection circuitry, damage may occur on devices subjected to high energy ESD. Therefore, proper ESD precautions should be taken to avoid performance degradation or loss of functionality.

### Legal Terms and Conditions

By using the evaluation board discussed herein (together with any tools, components documentation or support materials, the "Evaluation Board"), you are agreeing to be bound by the terms and conditions set forth below ("Agreement") unless you have purchased the Evaluation Board, in which case the Analog Devices Standard Terms and Conditions of Sale shall govern. Do not use the Evaluation Board until you have read and agreed to the Agreement. Your use of the Evaluation Board shall signify your acceptance of the Agreement. This Agreement is made by and between you ("Customer") and Analog Devices, Inc. ("ADI"), with its principal place of business at Subject to the terms and conditions of the Agreement, ADI hereby grants to Customer a free, limited, personal, temporary, non-exclusive, non-sublicensable, non-transferable license to use the Evaluation Board FOR EVALUATION PURPOSES ONLY. Customer understands and agrees that the Evaluation Board is provided for the sole and exclusive purpose referenced above, and agrees not to use the Evaluation Board for any other purpose. Furthermore, the license granted is expressly made subject to the following additional limitations: Customer shall not (i) rent, lease, display, sell, transfer, assign, sublicense, or distribute the Evaluation Board; and (ii) permit any Third Party to access the Evaluation Board. As used herein, the term "Third Party" includes any entity other than ADI, Customer, their employees, affiliates and in-house consultants. The Evaluation Board is NOT sold to Customer; all rights not expressly granted herein, including ownership of the Evaluation Board, are reserved by ADI. CONFIDENTIALITY. This Agreement and the Evaluation Board shall all be considered the confidential and proprietary information of ADI. Customer may not disclose or transfer any portion of the Evaluation Board to any other party for any reason. Upon discontinuation of use of the Evaluation Board or termination of this Agreement, Customer agrees to promptly return the Evaluation Board to ADI. ADDITIONAL RESTRICTIONS. Customer may not disassemble, decompile or reverse engineer chips on the Evaluation Board. Customer shall inform ADI of any occurred damages or any modifications or alterations it makes to the Evaluation Board, including but not limited to soldering or any other activity that affects the material content of the Evaluation Board. Modifications to the Evaluation Board must comply with applicable law, including but not limited to the RoHS Directive. TERMINATION. ADI may terminate this Agreement at any time upon giving written notice to Customer. Customer agrees to return to ADI the Evaluation Board at that time. LIMITATION OF LIABILITY. THE EVALUATION BOARD PROVIDED HEREUNDER IS PROVIDED "AS IS" AND ADI MAKES NO WARRANTIES OR REPRESENTATIONS OF ANY KIND WITH RESPECT TO IT. ADI SPECIFICALLY DISCLAIMS ANY REPRESENTATIONS, ENDORSEMENTS, GUARANTEES, OR WARRANTIES, EXPRESS OR IMPLIED, RELATED TO THE EVALUATION BOARD INCLUDING, BUT NOT LIMITED TO, THE IMPLIED WARRANTY OF MERCHANTABILITY, TITLE, FITNESS FOR A PARTICULAR PURPOSE OR NON-INFRINGEMENT OF INTELLECTUAL PROPERTY RIGHTS. IN NO EVENT WILL ADI AND ITS LICENSORS BE LIABLE FOR ANY INCIDENTAL, SPECIAL, INDIRECT, OR CONSEQUENTIAL DAMAGES RESULTING FROM CUSTOMER'S POSSESSION OR USE OF THE EVALUATION BOARD, INCLUDING BUT NOT LIMITED TO LOST PROFITS, DELAY COSTS, LABOR COSTS OR LOSS OF GOODWILL. ADI'S TOTAL LIABILITY FROM ANY AND ALL CAUSES SHALL BE LIMITED TO THE AMOUNT OF ONE HUNDRED US DOLLARS (\$100.00). EXPORT. Customer agrees that it will not directly or indirectly export the Evaluation Board to another country, and that it will comply with all applicable United States federal laws and regulations relating to exports. GOVERNING LAW. This Agreement shall be governed by and construed in accordance with the substantive laws of the Commonwealth of Massachusetts (excluding conflict of law rules). Any legal action regarding this Agreement will be heard in the state or federal courts having jurisdiction in Suffolk County, Massachusetts, and Customer hereby submits to the personal jurisdiction and venue of such courts. The United Nations Convention on Contracts for the International Sale of Goods shall not apply to this Agreement and is expressly disclaimed.

